



Customer Order Information

Have a Question?: We're here to serve you. Just give us a call and we'll be happy to help or to refer you to another source.

Business Hours: Shipping Warehouse only—**Sorry! No walk-in trade.**

Monday thru Friday, 9am to 5pm, Pacific Standard Time (West Coast). Closed for major holidays such as Thanksgiving, Christmas, etc.

How To Order: Orders of any size are welcome, we have NO minimums. To give you the best service, when phoning, please have ready the item number, quantity and description of the items you want to purchase. If you mail or fax an order to us, please be sure to include your full name, address and phone number where you can be reached in case we have any questions. Street addresses are required for UPS & Fedex delivery (no P. O. Boxes).

Website: **ronellock.com**

Orders Only: **1-800-334-0135**

Fax Orders (24 Hrs.): **541-471-0099**

For Info & Questions: **541-471-0194**

Email: **info@ronellock.com**

Mail In Orders: **P.O. Box 5510, Grants Pass, OR 97527**

Payment Information:

We accept Visa, Mastercard, Discover and American Express, money orders, cashier, personal or business checks. For overseas orders we accept all of the above. Payments are accepted in US currency **ONLY. NO COD's.**

Open Accounts are available on NET 30 DAY terms. Please request a credit application.

Returns, Exchanges & Claims:

Please contact us within 10 days of receipt of goods. When returning items, please include your name, address, phone number, a copy of your Invoice Receipt and a brief note stating the reason for your return and what you would like us to do for you to make your purchase satisfactory.

We can not accept returned merchandise that has been modified or altered from its original design. Credit or refunds can not be issued until the merchandise has been returned to us.

Special Orders:

Pre-Payment is required on Special Orders of an item we don't normally stock. Please allow approximately 2–4 weeks for Special Order delivery. There is a \$5.00 handling fee on returned Special Order items.

Pricing:

All prices, descriptions and specifications in this catalog are subject to change without notice. If you would like a price quote on any item in our catalog, please call **(541) 471-0194** or e-mail: **info@ronellock.com**. We are not responsible for typographical errors or omissions.

Shipping:

Unless otherwise requested we ship orders via Post, Fedex or UPS. We always try to ship the fastest and most economical way.

Faster Shipping Options:

UPS: Next Day, 2nd Day or 3rd Day Select

Fedex: Next Day and 2nd Day

For Overseas Shipments:

POST OFFICE ONLY

Please call for UPS Air and Fedex Air shipping rates

Call for shipping fees on solutions, weights, regulating stands, lyre pendulums, mainspring winders and bushing machines.

High Torque8-9
Motors.....15
Melody/Sound.....22
Military12
Micro Mini's.....6
Pendulum8-9, 11, 16-22
Radio Controlled.....10
Recordable17
Second Hand.....11
Set & Forget.....10
Skeleton.....13
Smooth Sweep4, 7
Snap-in.....5
Trigger/Time22
Tide/Time.....12
Thermometer.....11
Ultra-Long.....5
Movement Reg. Stands113

N
Numerals
Cuckoo87
Plastic.....41
Nuts, Hand.....75
Battery25
Cuckoo89
Nuts, Hex, misc75
Battery25
Nut Wrench.....103

O
O-Rings90
Oils & Grease117-118
Oil Cups & Bottles 118-119
Oilers118-119
Order Forms132
Ordering Info.....1

P
Paint
Glow in the Dark.....76
Pallet Fork.....72
Pallet Jewels.....74
Parts Holder, Univer
Drawers.....113
Racks.....113
Pegwood.....123
Pen Oilers.....118

Pendulum Case.....23
Pendulum
Anniversary.....13
Attachments, Lyre.....24
Battery24
Bobs60, 65
Cuckoo85
Drive Mechanism.....23
Hangers/Hooks.....65
Leaders.....66
Lyre.....58-59
Accessories60
Necks.....60
Novelty.....85
Reproductions64-65
Rods24, 66, 68
Sleeves.....24
Wood Stick66
Picks106
Pin Vises.....104
Pithwood.....123
Pivot Locator.....106
Pivots.....74
PlastiClean II120
Plate Spreader.....101
Platform Escapements ..72
Pliers.....105, 112
Pocket Watch Domes...51
Polish.....70, 121
Polish Cloths.....121
Pro-Cut Lube116
Punches
Centering.....102
Hole Closing102
Leather112
Metal.....102
Riveting.....102
Pulleys.....62

R
Racks, Cleaning122
Ratchet Wheels72
Rating Nuts.....65-66
Reamers98-99
Regulating Stands113
Repair Envelope.....76
Rinse Solution.....120
Riveting Hole Punch...102
Rodico121
Rouge.....121

Rubber Washers.....25
Ruler.....106
Rust Remover.....120

S
Safety Goggles.....114
Saw Blades.....109
Saw Frame.....109
Saw Wheels.....109
Scratch Brushes.....124
Scratch Kit.....121
Scratch Wheels.....124
Screwdrivers.....108
Blade Sharpener.....108
Gripper.....102
Screws.....72, 75-76
Scriber.....102
Second Hands
Battery32-33
Grandfather34
Shellac Stick.....121
Silikroil.....120
Sleeve Nut Tool103
Soldering Supplies.....116
Solutions, Cleaning.....120
Spring Bars, Watch.....76
Spring Bar Tool.....111
Springs, Clock.....75
Stabilizers, Wall.....53
Staff/Pivot Wire.....74
Stands, Clock Testing..113
Accessories113
Storage Containers.....77
Drawers113
Suspension, Rods68
Springs61-68
Steel68
Wire69

T
Tap & Die Set.....110
Taper Pins.....75
Telescoping Tools115
Tension Washers.....75
Thermometer Mvmt.....11
Dials.....11
Tools.....101-112
Torch.....116
Torsion Beat Calibrator..70
Transfer Rub-ons.....46-48
Tweezers.....105, 115

U
Universal Parts Holder 104
Urgos Parts.....73

V
Vacu-Seal.....119
Verges69
Hermle73
Vise, Bench.....104
Vises, Pin.....104
Visors, Magnifying.....114
Accessories114
Headband.....114
Light.....114

W
Wall Mount
Movement Housing....25
Wall Stabilizers53
Washers
Flat.....75
Hand.....75
Tension.....75
Wash Cup/Beaker122
Watch
Case Openers ... 111-112
Hand Pullers.....107
Holder.....112
Key, 5 Prong.....80
Notching Pliers112
Spring Bars.....76
Spring Bar Tool.....111
Stands.....52-53
Winding Tool.....112
Weights
Caps.....61
Cuckoo89
Hooks/Nuts/Rings.....61
Lead Inserts.....61
Shells.....58-61
Wheels.....73
Winding Arbor, Fake81
Wire.....74
Bending Tools.....107
Wood Pend. Sticks.....66
Wood Repair Sticks.....121
Wrenches.....103

Z
Zip-Lock Bags.....76



• TO ORDER •

Visit Our Website:

ronellclock.com

Special
Discount Coupons!!
Page 132



By Phone: **1-800-334-0135**
Fax (24 Hrs): **541-471-0099**



By Mail: **Ronell Clock Co.**
PO Box 5510, Grants Pass, OR 97527



By e-Mail: **info@ronellclock.com** Info: **541-471-0194**

In order to give you the best quality & prices we have a shipping warehouse only. No Walk-In Trade.

Mini Quartz Movements

Our Best Seller

U.S. Made - Takane

Accurate, Dependable & Versatile!! Lifetime Warranty



Specifications:

Size: 2-1/8"W x 2-1/8"H x 5/8"D
 Shaft diameter: 5/16" (8mm)
 Motor: self-start, 1 second step
 Rear hand set knob
 Battery: 1 'AA' (not included)
 Includes mounting hardware
 Hands sold separately
 Hangers available upon request
 Powers-up to 6" hands

Item No.	Threaded Shaft Length	Overall
MTW-20XS <i>New</i>	3/16"	1/2"
MTW-20S	5/16"	9/16"
MTW-20M	7/16"	11/16"
MTW-20ML	9/16"	13/16"
MTW-20L	11/16"	15/16"

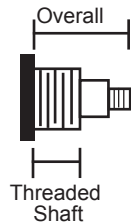

1	3	6	12	30	50	100+
\$3.75	\$3.50	\$3.00	\$2.75	\$2.50	\$2.30	\$2.20

New Direct Import

Continuous Sweep

Silent Running - No Ticking Sound
 One Year Warranty



Specifications:

Size: 2-3/16"W x 2-3/16"H x 5/8"D
 Shaft diameter: 5/16" (8mm)
 Rear hand set knob
 Battery: 1 'AA' (not included)
 Includes mounting hardware
 Hands sold separately
 Hangers available upon request
 Powers-up to 6" hands.

Item No.	Threaded Shaft Length	Overall
MTW-80XS	3/16"	1/2"
MTW-80S	5/16"	5/8"
MTW-80M	7/16"	3/4"
MTW-80L	9/16"	7/8"

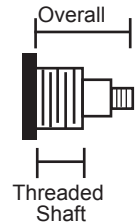

1	3	6	12	30	50	100+
\$4.50	\$4.25	\$4.00	\$3.75	\$3.50	\$3.25	\$3.00

New Direct Import

Our Lowest Price

Made by one of China's largest
 Movement Manufacturers. One Year Warranty.



Specifications:

Size: 2-1/8"W x 2-1/8"H x 5/8"D
 Shaft diameter: 5/16" (8mm)
 Front & rear hand set
 Battery: 1 'AA' (not included)
 Includes mounting hardware
 Hands sold separately
 Hangers available upon request
 Powers-up to 6" hands

Item No.	Threaded Shaft Length	Overall
MTW-35XS	3/16"	1/2"
MTW-35S	5/16"	5/8"
MTW-35M	1/2"	3/4"
MTW-35ML	5/8"	7/8"

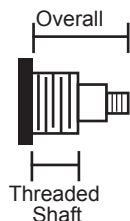

1	3	6	12	30	50	100+
\$2.95	\$2.75	\$2.50	\$2.25	\$2.00	\$1.75	\$1.65

Seiko Quiet Step

Two Year Warranty.
 Quiet Second Hand Motion. Efficiency & Accuracy.



Specifications:

Size: 2-1/8"W x 2-1/8"H x 1/2"D
 Shaft diameter: 5/16" (8mm)
 Front & rear hand set
 Battery: 1 'AA' (not included)
 Includes mounting hardware
 Hands sold separately
 Hangers available upon request
 Powers-up to 6" hands

Item No.	Threaded Shaft Length	Overall
MTW-70XS <i>New</i>	3/16"	1/2"
MTW-70S	5/16"	5/8"
MTW-70M	9/16"	7/8"
MTW-70L	3/4"	1-1/16"

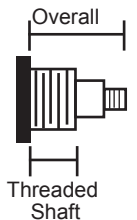

1	3	6	12	30+
\$5.00	\$4.75	\$4.50	\$4.25	\$4.15

Hands H-01 thru H-46 on pages 28-31, 20¢ a pair with movement purchase.

Takane Ultra Long

For that Extra Thick Dial



Specifications:

Size: 2-1/8"W x 2-1/8"H x 5/8"D
 Shaft diameter: 5/16"
 Battery: 1 'AA' (not included)
 Includes all mounting hardware.
 Hands sold separately.
 Hanger available upon request.

Item No.	Threaded Shaft Length	Overall
MTW-10XL	15/16"	1-3/16"

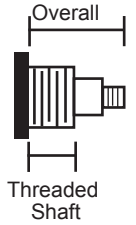

1	3	6	12	30	50	100+
\$3.85	\$3.60	\$3.10	\$2.85	\$2.60	\$2.40	\$2.30

Hands H-01 thru H-46 on pages 28-31 20¢ a pair with movement purchase.

New Direct Import

Snap-In Movements With Press-On Hands

For clocks with snap-in housings. Used by many mass clock producers.



Specifications:

Size: 2-1/8"W x 2-1/8"H x 5/8"Deep
 Shaft dia. for MTW-40: 3/16"
 Shaft dia. for MTW-41: 5/16"
 Hour post dia. 5.0mm
 Minute post dia. 3.5mm
 Battery: 1 'AA', (not included)
 On MTW-41 hardware is included
 Finishing end caps available upon request

BLACK ONLY. Hands 20¢ pr. with movement purchase.

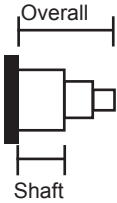
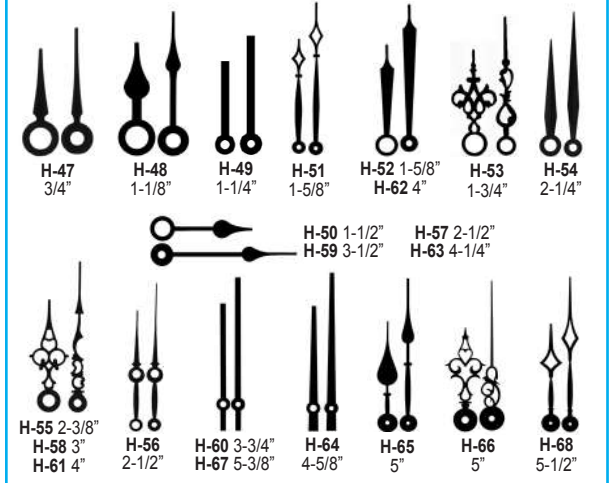

Without Threaded Shaft

Item No.	Shaft Length	Overall
MTW-40S	1/8"	3/8"
MTW-40M	5/16"	7/16"

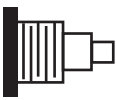

With Threaded Shaft

Item No.	Threaded Shaft Length	Overall
MTW-41XS	3/16"	3/8"
MTW-41S	1/4"	1/2"
MTW-41M	3/8"	3/4"

1	3	6	12	30+
\$4.65	\$4.40	\$4.15	\$3.50	\$2.95

Square Snap-In Mini Movement

Alarm & Non-Alarm

MSN-23



MSA-23

Specifications:

Case size: 2-1/8"W x 2-1/8"H x 5/8"D
 Press fit hand shaft
 Rear hand set knob
 2 screw holes for mounting,
 Battery: 1 'AA' (not included)
 10 year warranty. Made in USA
 Alarm hand comes with alarm movement

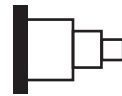

Hands 20¢ pr. with movement purchase.

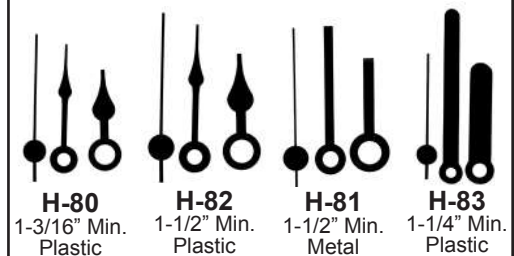

Item No.	Description	Shaft Length	Overall Shaft Length	Shaft Dia.	1	3	6	12+
MSA-23	Alarm	3/16"	1/4"	1/4"	\$8.95	\$8.50	\$7.95	\$7.50
MSN-23S	Non-Alarm	1/16"	3/16"	3/16"	\$4.95	\$4.50	\$3.95	\$3.50
MSN-23M	Non-Alarm	3/16"	5/16"	3/16"				

May mix style & shaft lengths to receive quantity discounts.

Carriage Clock Movement

Compact Size. Great for Carriage, Miniature Desk Clocks & Special Craft Projects.

Made in Germany



Item No.
MCN-24M

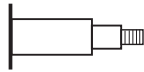

Extra Long Shaft!

Takes standard 'I' shaft hands!

Hands H-01 thru H-46 on pages 28-31, 20¢ a pair with movement purchase.

Hands 20¢ pr. with movement purchase.

Red Alarm 1-1/8"

H-88 1" Min.

H-89 1-1/8" Min.



Hands in Black

Item No.
MCA-24
MCN-24S

Specifications:

Case size: 2" dia. x 5/8" deep
Rear hand set knob.
Battery: 1 'N' (not included)
MCN-24M Includes hardware
Hands sold separately
Runs up to 4" hands

Item No.	Description	Shaft Length	Overall Shaft Length	1	3	6	12+
MCA-24	Alarm	3/32"	1/4"	\$12.95	\$11.95	\$10.95	\$10.50
MCN-24S	Non-Alarm	3/32"	3/16"	\$10.95	\$9.95	\$9.50	\$8.95
MCN-24M	Non-Alarm	3/16"	5/8"				

German Mini Movement

Sleeve nut mounting is great for fragile porcelain clocks.



Item No.
MCN-22

Specifications:

Case size: 2" diameter x 5/8" deep
Shaft length: 3/32" to 3/16"
Overall shaft length: 3/8"
Press fit shaft. Rear hand set knob
Battery: 1 'N' (not included)

See Hands H-87 thru H-89 above.
20¢ pr. with movement purchase.

1	3	6	12+
\$12.95	\$11.95	\$10.95	\$10.50

Slim Micro Mini Movements Alarm and Non-Alarm



Specifications:

Case size: 1-9/16" dia., 5/16" deep.
Shaft dia.: 3/32
2 screw holes for mounting
Battery: 1 watch battery (included)

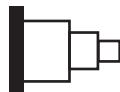

Hands 20¢ pr. with movement purchase.

Hands in Black

Silver Alarm 13/16"

Black Sweep 11/16"

H-96 5/8" Min.

H-97 3/4" Min.

H-98 7/8" Min.

Item No.	Description	Shaft Length	Overall Shaft Length	1	6	12+
MYA-129	Alarm	3/32"	5/32"	\$7.50	\$6.95	\$6.50
MYM-129S	Non-Alarm	1/16"	3/32"	\$6.95	\$6.50	\$5.95
MYM-129M	Non-Alarm	3/32"	5/32"			

Micro Mini Movement

Great Quality At A Great Price!

Specifications:

Case size: 2" diameter, 5/8" deep
Shaft length: 5/32". Overall length: 3/16"
Shaft diameter: 1/16"
3 screw holes for mounting
Battery: 1 'N' (not included)



Item No.
MYM-128

Hands 20¢ pr. with movement purchase.

Black Hands H-101 1-1/2" Minute Hand

Red Sweep H-102 1-3/4" Minute Hand

1	3	6	12+
\$6.95	\$6.50	\$5.95	\$5.50

High Torque Movements

Seiko Continuous Sweep

Silent Running - Powers Up To 14-1/2" Hands



Specifications:
 Case size: 2-3/16"W x 2-3/16"H x 9/16"D
 Shaft diameter: 5/16"
 Threaded shaft length: 3/8"
 Overall shaft length: 11/16"
 Battery: 1 'AA' (not included)
 Includes mounting hardware
 Hands sold separately
 Will run a large sweep second hand
 Hangers available upon request

Item No. **MTW-84**

Extra large hands sold on pages 26-27

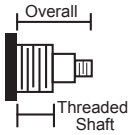

1	3	6	12	30+
\$9.95	\$9.50	\$8.95	\$7.95	\$7.50

German Extra Power

Powers Up To 17-1/2" Hands

The most powerful High Torque on the Market Today!



Specifications:
 Case size: 2-1/4"W x 2"H x 5/8"D
 Shaft diameter: 3/8"
 Overall shaft length: 13/16"
 3 year warranty.
 Battery: 1 'AA' (not included)
 Includes mounting hardware
 Hands sold separately.
 Large sweep second hand
 NOT recommended
 Hangers available upon request

MTW-83

Extra large hands sold on pages 26-27

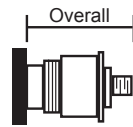

Item No.	Collar Sleeve Depth
MTW-83S	1/16"
MTW-83M	1/4"

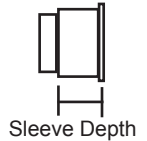

1	3	6	12	30	50	100+
\$8.95	\$8.50	\$8.25	\$7.95	\$7.50	\$6.95	\$5.95

New Direct Import

Youngtown Silent Running

Extra Spacing
 Runs up to 17-3/4" Hands



Specifications:
 Size: 2-1/8"W x 2-1/8"H x 5/8"D
 Shaft diameter: 5/16" (8mm)
 Battery: 1 'AA' (not included)
 Includes mounting hardware
 Hands sold separately
 Hangers available upon request

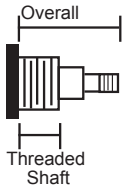

Item No.	Threaded Shaft Length	Overall
MTW-91S	7/16"	7/8"
MTW-91M	9/16"	1"

Increased distance between the hour & minute hands to prevent binding.

Extra large hands sold on pages 26-27

1	3	6	12	30+
\$8.95	\$8.50	\$7.95	\$6.95	\$5.95

New Extra Long Shaft

Powers Up To 17-1/2" Hands



Specifications:
 Case size: 2-1/8"W x 2-1/8"H x 5/8"D
 Shaft diameter: 5/16"
 Threaded shaft length: 7/8"
 Overall shaft length: 1-3/16"
 Lifetime warranty
 Battery: 1 'AA' (not included)
 Includes mounting hardware
 Hands sold separately
 Large sweep second hand
 NOT recommended
 Hangers available upon request

Item No. **MTW-89XL**

Extra large hands sold on pages 26-27



1	3	6	12	30+
\$6.95	\$6.50	\$6.25	\$5.75	\$4.25

New Direct Import

Youngtown 'C' Cell

Extra Spacing - Runs up to 24" Hands



Specifications:
 Case size: 2-1/8"W x 2-1/2"H x 3/4"D
 Shaft dia.: 5/16"
 Battery: 1 'C' (not included)
 Includes mounting hardware
 Hands sold separately

Item No.	Threaded Shaft Length	Overall
MTW-92M	7/16"	7/8"
MTW-92L	9/16"	1"

1	3	6	12	30+
\$8.95	\$8.50	\$7.95	\$7.50	\$6.95

Takane High Torque Movements

Non-Pendulum



Case Size: 2-1/8"W x 2-3/4"H x 1"D

Item No.	Threaded Shaft Length	Overall
MTW-85S	7/16"	3/4"
MTW-85M	11/16"	1"
MTW-85L	15/16"	1-1/4"

1	3	6	12	30+
\$8.95	\$7.95	\$6.95	\$6.50	\$5.95

Powers Up To 12" Hands

Specifications:

Shaft diameter: 7/16"

Made in the U.S.A.

5 year warranty

Battery: 1 'C' (not included)

Includes mounting hardware

Hands sold separately

Large sweep second hand

NOT recommended

Hangers available upon request

MTP-30 movements come with

16" adjustable pendulum

Choice of 2-1/8", 2-3/4", or 3-1/2" bob upon request

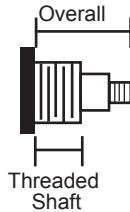

Hands **H-01** thru **H-46** on pages 28-31, 20¢ a pair with movement purchase.

Extra large hands sold on pages 26-27

Pendulum



Runs up to a 23" battery pendulum.

Case Size: 3"W x 3-1/2"H x 1-1/8"D

Item No.	Threaded Shaft Length	Overall
MTP-30S	7/16"	3/4"
MTP-30M	11/16"	1"
MTP-30L	15/16"	1-1/4"

1	3	6	12+
\$14.95	\$14.50	\$13.95	\$13.50

High Torque 4/4 Westminster Chime Pendulum Movement

New Extra Spacing - Runs up to 18" Hands!

First high torque chime movement ever made! Plays 4/4 Westminster chime melody every 15 minutes with counting strike on the hour. Increased distance between hour and minute hands to prevent binding.



Specifications:

Case size:

3"W x 4-9/16"H x 1-1/4"D

Shaft diameter: 7/16"

Threaded shaft length: 7/16"

Overall shaft length: 7/8"

Rear hand set knob

Battery: 1 'C' (not included)

Attached, enclosed

tube speaker

Includes mounting hardware

16" adjustable pendulum

Choice of 2-1/8", 2-3/4" or

3-1/2" bob upon request

Hands sold separately

Hangers available upon request

Item No. **MWC-2507**

Extra large hands sold on pages 26-27

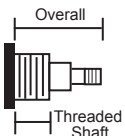

1	3	6+
\$39.95	\$37.95	\$35.95

High Torque Pendulum Movement

New

Extra Spacing 'AA' - Runs up to 15" Hands!



Specifications:

Case size:

2-1/8"W x 4-1/4"H x 5/8"D

Shaft diameter: 5/16"

Battery: 1 'AA' (not included)

Runs up to a 27" battery

pendulum

Includes mounting hardware

16" adjustable pendulum

Choice of 2-1/8", 2-3/4" or

3-1/2" bob upon request

Extra large hands sold on pages 26-27

Item No.	Threaded Shaft Length	Overall
MTP-15S	3/8"	7/8"
MTP-15L	11/16"	1-1/8"

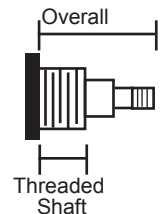

1	3	6	12+
\$10.95	\$10.50	\$9.95	\$9.50

Extra Spacing High Torque Movements

Increased Distance Between the Hour & Minute Hands To Prevent Binding.

Takane Mini

Extra Spacing - Powers Up To 17-1/2" Hands



Specifications:
 Case size: 2-1/8"W x 2-1/8"H x 5/8"D
 Shaft diameter: 5/16"
 Battery: 1 'AA' (not included)
 Includes mounting hardware.
 Hands sold separately.
 Large sweep second hand NOT recommended.
 Hangers available upon request.

Item No.	Threaded Shaft Length	Overall
MTW-89S	7/16"	7/8"
New MTW-89L	11/16"	1-1/8"

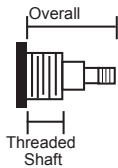

Extra large hands sold on pages 26-27

1	3	6	12	30+
\$6.95	\$6.50	\$6.25	\$5.75	\$4.25

Takane Continuous Sweep

Extra Spacing - Powers Up To 17-1/2" Hands



Specifications:
 Case size: 2-1/8"W x 2-3/4"H x 1"D
 Shaft diameter: 7/16"
 Threaded shaft length: 7/16"
 Overall shaft length: 7/8"
 Battery: 1 'C' (not included)
 Includes mounting hardware.
 Hands sold separately.
 Large sweep second hand NOT recommended.
 Hangers available upon request.

Item No. **MTW-90**

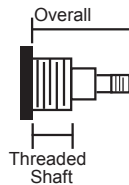

Extra large hands sold on pages 26-27

1	3	6	12	30+
\$15.95	\$15.50	\$14.95	\$14.50	\$13.95

Non-Pendulum

Extra Spacing - Powers Up To 17-1/2" Hands



Case Size: 2-1/8"W x 2-3/4"H x 1"D

Item No.	Threaded Shaft Length	Overall
MTW-87S	7/16"	7/8"
MTW-87L	11/16"	1-1/8"

1	3	6	12	30+
\$12.50	\$11.50	\$10.50	\$9.95	\$9.50

Takane

Specifications:

Shaft diameter: 7/16"
 3 year warranty.
 Battery: 1 'C' (not included)
 Includes mounting hardware.
 Hands sold separately.
 Large sweep second hand NOT recommended.
 Hangers available upon request.

MTP-88 includes
 16" adjustable pendulum. Choice of 2-1/8",
 2-3/4", or 3-1/2" bob upon request.

Extra large hands sold on pages 26-27

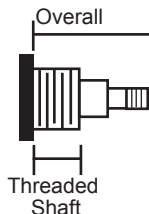

Pendulum



Item No. **MTP-88**

Case Size: 3"W x 3-1/2"H x 1-1/8"D
 Threaded shaft length: 7/16"
 Overall shaft length: 7/8"

Runs up to a 23" battery pendulum.

1	3	6	12	30+
\$18.95	\$18.50	\$17.95	\$17.50	\$16.95

Hands H-01 thru H-46 on pages 28-31, 20¢ a pair with movement purchase.

May mix any High Torque Movements to receive quantity discounts.

Daylight Saving Time Movements

New Quartz



Battery:
1 'AA'
(not included)

Set and Forget Movements

Works in all 4 American time zones.
This movement has an internal pre-programmed chip which will automatically adjust in the Spring and Fall to the correct time.

Specifications:

Case size:
2-1/8"W x 2-1/8"H x 5/8"D
Shaft diameter: 5/16"
Step second motion
Rear hand set knob
Includes mounting hardware
Hangers available upon request

Electric New



Comes with
5' 9" cord

Item No.	Threaded Shaft Length	Overall
MSF-01S	3/16"	5/8"
MSF-01L	3/4"	1-3/16"

1	3	6	12+
\$11.95	\$10.95	\$10.50	\$9.95

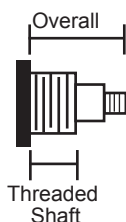

Item No.	Threaded Shaft Length	Overall
MSF-02S	3/16"	5/8"
MSF-02L	3/4"	1-1/8"

1	3	6	12+
\$15.95	\$14.95	\$13.95	\$13.50

Radio Controlled Movement



Specifications:

Case size:
2-3/16"W x 3-5/8"H x 5/8"D
Shaft diameter: 5/16"
Step second motion
1 year warranty
Battery: 1 'AA' (not included)
Includes mounting hardware
Sweep second hand is NOT required to set the clock

*Due to radio signal, this movement should not be used with metal dials.

U.S.A. Auto Set Movement

Extra Spacing High Torque
Powers Up To 18" Hands

New



Item No.
MSF-03

Specifications:

Case Size:
2-1/4"W x 2-1/4"H x 5/8"D
Shaft diameter: 5/16"
Threaded shaft length: 5/16"
Overall shaft length: 3/4"
Battery: 1 'AA' (not included)
Includes mounting hardware
Increased distance between the hour & minute hands to prevent binding

No radio or computer signal!

This movement has an internal pre-programmed chip which will automatically adjust in the Spring and Fall to the correct time. Works in all four American time zones. In the Fall the movement will stop for an hour and in the Spring it will "fast forward" for one hour.

Item No.	Threaded Shaft Length	Overall
MRC-65S	3/16"	7/16"
MRC-65M	1/4"	9/16"
MRC-65ML	3/8"	11/16"

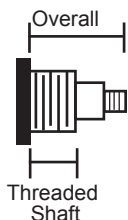

1	3	6	12+
\$17.50	\$16.50	\$15.50	\$14.50

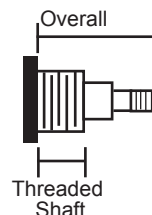

1	3	6	12+
\$16.95	\$16.50	\$15.95	\$15.50

Hands H-01 thru H-46 on pages 29-31, 20¢ a pair with movement purchase.

Specialty Movements & Accessories

Quartz Calendar Movements

The 31-Day calendar hand on this movement works off the center shaft and functions just like an antique mechanical calendar movement!

Non-Pendulum

Specifications:

Case size: 2-3/16"W x 2-3/16"H x 3/4"D
 Shaft diameter: 7/16"
 Threaded shaft length: 3/8"
 Overall shaft length: 7/8"
 Battery: 1 'AA' (not included)
 Separate time & date knobs
 Includes mounting hardware
 Hands sold separately



Item No.
MPC-120

1	3	6+
\$9.95	\$9.75	\$9.50

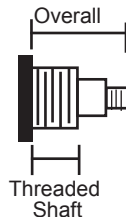

Hands **H-01** thru **H-46** on pages 29-31, 20¢ a pair with movement purchase.

Pendulum

Specifications:

Case size: 2-1/4"W x 5"H x 1-1/4"D
 Shaft diameter: 7/16"
 Threaded shaft length: 3/8"
 Overall shaft length: 7/8"
 Battery: 2 'AA' (not included)
 Separate time & date knobs
 Includes 16" adjustable pendulum with your choice of a 2-1/8", 2-3/4" or 3-1/2" diameter bob upon request
 Includes mounting hardware
 Hands sold separately



Item No.
MPC-125

Runs up to a 32" battery pendulum.

1	3	6+
\$13.95	\$13.75	\$13.50

Red Calendar Hands

Measured from center of hole to tip.

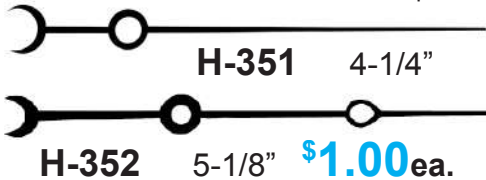

H-351 4-1/4"
H-352 5-1/8" **\$1.00** ea.

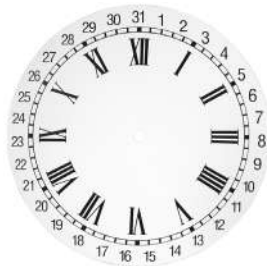

Calendar Dials

Styrene dial. Roman numeral track, Arabic numeral dates.

Color	9-7/8" Dial 8-1/4" Time Track	11-1/8" Dial 8-7/8" Time Track
White	D12-9W	D12-11W
Ivory	D12-9V	D12-11V

1 **\$3.50**
3+ **\$3.25**

Thermometer Movement

Specifications:

Case size: 2" Dia., 5/8" thick
 Shaft diameter: 5/16" Bimetal Thermometer Coil. Rotatable rear cover with 2" markings & arrow for easy calibration & setting.
 Temperature Range: -40°F to 165°F (-40°C to 74°C)
 Battery not required Includes: mounting hardware & instructions.



Hands **H-01** thru **H-46** on pages 29-31, 20¢ a pair with movement purchase.
 Uses *minute* hands only.

Item No.	Threaded Shaft Length	Overall
MTH-11S	1/4"	7/16"
MTH-11M	9/16"	13/16"
1	6	12+
\$4.35	\$4.00	\$3.75

Thermometer Hand Red, 5" from center hole to tip. 8" overall length. Item No. **H-150** **\$2.00**



Styrene Dial 6-5/8" white dial, black numerals. Blue to red temperature track. Fahrenheit & Celsius. Item No. **DT-658** **\$2.30**



Second Hand Only Movement

A specialty custom movement made for Time Works and other large clocks. Made in the U.S.A.

New & Exclusive to Ronell!



Item No.
MTW-30

\$7.95

Specifications:

Case Size: 2-1/8" x 2-1/8"
 Shaft Dia: 5/16"
 Shaft Length: 7/16"
 Battery: 1 AA battery (not included)

Reverse/Backwards Time



A whole new perspective in timekeeping. Great quartz accuracy in REVERSE yet still allows you to read the correct time. Called the "Barbershop" clock because customers would view the clock in the mirror. Available with dial in 6-1/2" metal or 9-1/2" styrene. White dial with black numbers. Includes mounting hardware. Hands sold separately.

Specifications:

Case size: 2-1/4" x 2-1/4" x 5/8"D
 Shaft diameter: 5/16"
 Threaded shaft length: 1/4"
 Overall shaft length: 9/16"
 Battery: 1 'AA' (not included)

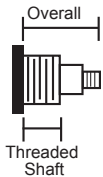

Item No.	Dial Size	1	3	6	12+
MTW-21S	Movement Only	\$6.25	\$5.75	\$5.50	\$4.25
DM-21-6	6" Metal	\$5.50	\$5.25	\$5.00	\$4.75
DM-21-9	9-1/2" Styrene				

24 Hr. Military Time



Quartz technology assures accurate timekeeping. A great way to learn military time. Available with 24 hour military dials in 6" or 10" metal. White dial with black numbers. Includes mounting hardware. Hands sold separately.

Specifications:

Case size: 2-1/4" x 2-1/4" x 5/8"D
 Shaft diameter: 5/16"
 Threaded shaft length: 5/16"
 Overall shaft length 11/16"
 Battery: 1 'AA' (not included)

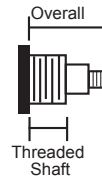

Item No.	Dial Size	1	3	6	12+
MTW-24	Mvmt Only	\$7.50	\$6.95	\$6.50	\$5.95
DM-24-6	6"	\$4.50	\$4.25	\$3.95	\$3.50
DM-24-10	10"	\$6.50	\$6.00	\$5.50	\$5.00

Time Tide Movement

Movement tells the time and high & low tide based on the lunar day of 24 hour, 50 minute.

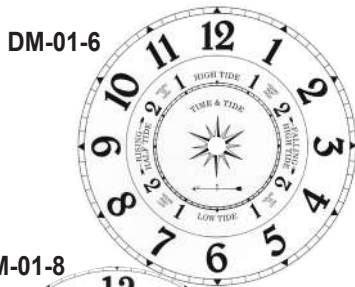

Specifications:

Case size:
 2-1/8"W x 2-7/8"H x 1"D
 Shaft diameter: 3/8"
 Threaded shaft length: 3/8"
 Overall shaft length: 7/8"
 Battery: 1 'AA' (not included)
 Includes: styrene dial, red tide indicator hand, & all mounting hardware.

Hands sold separately.

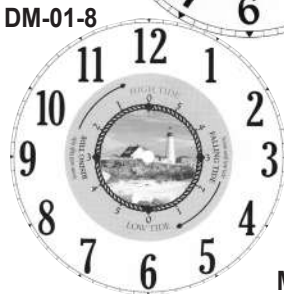

Item No.	Dial Size	1	3	6+
MTD-01	Movement Only	\$12.95	\$12.50	\$11.95
DM-01-6	6-7/8" dia. Metal	\$5.75	\$5.50	\$5.00
DM-01-8	8" dia. Styrene	\$4.50	\$4.25	\$3.95

New Tide Movement

Movement tells the high & low tide based on the lunar day of 24 hour, 50 minute.

DM-02-4

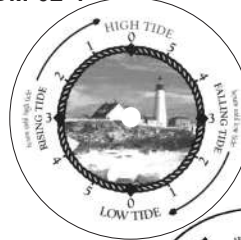

Specifications:

Case Size: 2-1/8"W x 2-1/8"H x 5/8"D
 Shaft diameter: 5/16"
 Built in hanger holds up to 4lbs.
 6 year warranty
 RoHS compliant

Battery: 1 'AA' (not included)
 Includes: red tide indicator hand & mounting hardware.

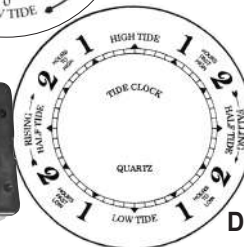

DM-02-6

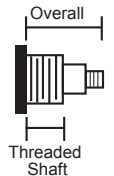

Item No.	Threaded Shaft Length	Overall Shaft Length	1	3	6+
MTD-02S Movement Only	1/8"	7/16"	\$8.95	\$7.95	\$6.95
MTD-02M Movement Only	1/4"	11/16"	\$8.95	\$7.95	\$6.95
DM-02-4 Dial Only	4-1/4" dia.	Styrene	\$3.50	\$3.25	\$3.00
DM-02-6 Dial Only	6-7/8" dia.	Metal	\$5.75	\$5.50	\$5.00

Hands H-01 thru H-46 on pages 29-31, 20¢ a pair with movement purchase.

All Movement Styles on this page may be combined to receive quantity discounts.

Anniversary Movements

Quartz Skeleton Movement with Posts - Brass Plated Metal



New Direct Import
Specifications:

4-1/2" dia. dial - brushed gold finish
1-5/8"D, 6-1/2" high with posts
Posts: 2-1/4"H, 2-3/4" apart from center to center
Second bit: 1-3/16" dia.
Polished gold gears & posts
Battery: 1 'AA' (not included)
Comes with black hands & sweep

Item No. **MST-110**

1	3+
\$19.95	\$17.50

3-1/8" Fancy Rotating Pendulum Drive Movement

New Direct Import



Specifications:

Case size:
2-1/4"W x 2-1/4"H x 5/8"D
Pendulum: 2-1/2"H,
1-5/8" dia., gold finish.
Assembled height: 3-1/8"
Battery: 1 'AA' (not included)

Does NOT regulate or run timekeeping.
Center position shaft.
Beautiful ball pendulum resting on a gold tone platform with 4 decorative flairs.
The movement mounts under the clock base with the shaft protruding through the base hole.
The ball pendulum mounts to the shaft.

Item No. **MAB-320**

1	3	6+
\$7.95	\$7.50	\$7.25

Quartz Skeleton Movement Brass Plated Metal

New Direct Import



Specifications:

4-1/2" dia. dial - brushed gold finish, 1-5/8"D
Polished gold gears
1-3/16" dia. second bit
Brushed brass dial, polished brass gears
Battery: 1 'AA' (not included)
Comes with black hands and sweeps

Item No. **MST-120**

1	3+
\$19.95	\$17.50

3-1/2" Rotating Pendulum Drive Movement

Specifications:

Case size:
2-1/8"W x 2-1/4"H x 5/8"D
Pendulum: 2-5/8"H x 2-3/4" dia.
Gold finish.
Assembled height: 3-1/2"
Battery: 1 'AA' (not included)

Does NOT regulate or run timekeeping.
Off-center positioned shaft.
The movement mounts under the clock base with the shaft protruding through the base hole.
The ball pendulum mounts to the shaft.



Item No. **MAB-328**

1	3	6+
\$12.95	\$12.50	\$11.95

Quartz Skeleton 4" Fit-up Movement

New Direct Import



Specifications:

4" dia. front bezel
3-1/2" dia. movement back (fits in a 3-5/8" hole)
Brushed gold finish dial, polished gold finish gears
Rubber friction gasket included
Battery: 1 'AA' (not included)
Clear acrylic back to view movement. Small second bit at 6 o'clock. Screw-off bezel glass lens.

Item No. **MST-130**

1	2+
\$18.95	\$16.50

All Movement Styles on this page may be combined to receive quantity discounts.

Electric Movements

MEM-19

New

Hansen Threaded Shaft Electric Movement

These are a type C-5, 12 hour electric movements.

Specifications: Size: 2-1/4"W x 3-1/4"H x 1-15/16"D 1 RPM, 60 Hz, 110V, 3W

May mix Hansen movements to receive quantity discounts.

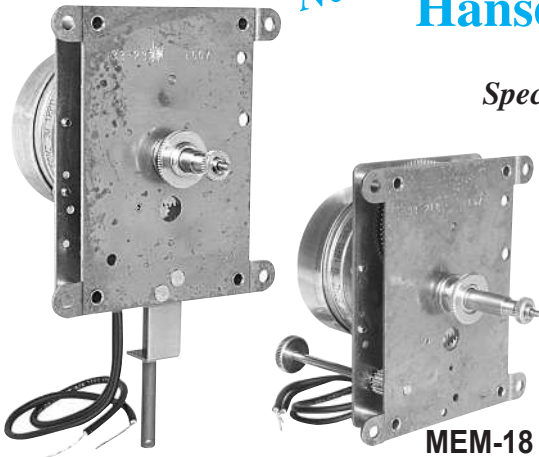

Style	Threaded Shaft Length	Overall Shaft Length	Item No.	1	3+
Rear Set	5/16"	1"	MEM-18M	\$59.95	\$57.95
	5/16"	1-3/8"	MEM-18L		
Bottom Set	5/16"	1"	MEM-19M		
	5/16"	1-3/8"	MEM-19L		

Compact Electric Movements

Uses Standard 'I' Shaft Battery Movement Hands

Quartz motor for proven time-keeping accuracy and reliability. Compact size for versatile clock design. Standard 12 Hour Time. Made in the USA. UL approved.



Specifications:

Case size: 2-1/4"W x 2-1/4"H x 5/8"D.

Shaft diameter: 5/16".

Voltage: 110 Volts/60 Hz.

Rear hand set knob.

Accommodates standard 'I' shaft hands

and a sweep second hand. Hands sold separately.

Includes: a 6 foot, 2-prong plug, black cord

and mounting hardware.

Hangers available upon request.

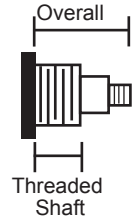

Hands H-01 thru H-46 on pages 28-31, 20¢ a pair with movement purchase.

Item No.	Threaded Shaft Length	Overall	1	3+	6	12+
MEC-12S	3/16"	15/16"	\$7.95	\$7.50	\$6.95	\$6.75
MEC-12M	9/16"	15/16"				
MEC-12L	15/16"	1-1/4"				

New Battery to Electric Converter Cords

Our new "Uninterrupted Powers Sources" are nothing short of amazing!

These devices allow you to operate any clock movement that runs a AA or C cell battery on a standard 110 volt wall outlet. These converter cords have a Ni-Cad back up battery which kicks in during a power outage allowing your clock to operate for weeks (if needed) on the battery alone!

- UL approved
- Converts 110 volts AC to 1.5 volts DC
- Includes a 6 foot, 2-prong plug, black power cord
- Ni-Cad battery is constantly being "trickle charged"

Item No.	1	3	6	12+
MEC-1A 'AA'	\$9.95	\$8.95	\$8.50	\$7.95
MEC-2C 'C'	\$11.50	\$10.50	\$10.00	\$9.50



Hansen Movements & Motors



New Hansen Light Duty Electric Movements

Rear set movement with threaded shaft for mounting. 1RPM, 60 Hz, 110V, 3W.
2"W x 2-1/2"H x 2"D

\$59.00 ea.

Note: battery hands will fit if the minute hand is filed slightly larger.

Item No.	Threaded Shaft Length	Overall
MEM-14S	5/16"	1"
MEM-14M	5/16"	1-3/8"
MEM-14L	5/16"	2-5/8"



Hand Nuts

For Shaft Length
 Item No. **MEM-68H** Medium (02)
MEM-69H Long (04)

\$1.00 ea.

Motor Mounting Screws



Phillips Head
 Item No. **MEM-322S**

50¢ ea.

These screws are for mounting the motor to the movement plates (4 required). Not to be used for mounting movement to clock case.

Hansen Electric Movements

3-1/4"H x 2-1/4"W x 1-15/16"D

Style	Overall Shaft Length	Item No.	1	3+
Rear Set	3/4"	MEM-15M	\$38.95	\$38.00
	1"	MEM-15L		
Bottom Set <i>New</i>	3/4"	MEM-16M		
	1"	MEM-16L		
	1-1/4"	MEM-16XL	\$40.95	\$39.95

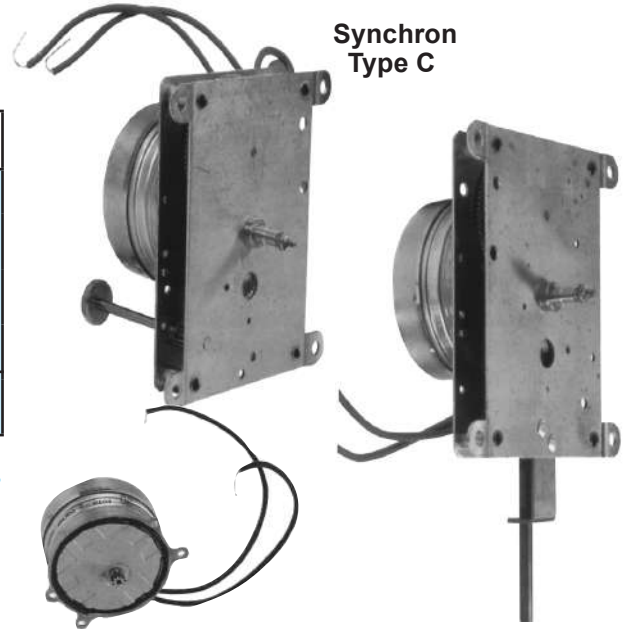

Synchron Type C

Hansen #A43RA "Synchron" Motor

Complete with 10-tooth pinion, 1 RPM, 60Hz, 110V. For Type C movement and #610, 143R, A44RA & 288-003.

Motor only Item No. **MEM-17**

1 **\$26.00** ea. 3 + **\$25.00** ea.

Hansen Motor Hands

3pc. set, black only, red sweep

Dial Size	Minute Hand Length	For Med. Shaft	For Long Shaft	Price Each
12"	5-1/4"	H-200	H-204	\$16.00
15"	6-9/16"	H-201	-----	\$18.00
15"	6-5/16"	-----	H-205	\$18.00
18"	8"	H-202	H-206	\$21.00
24"	10-5/8"	-----	H-207	\$23.00

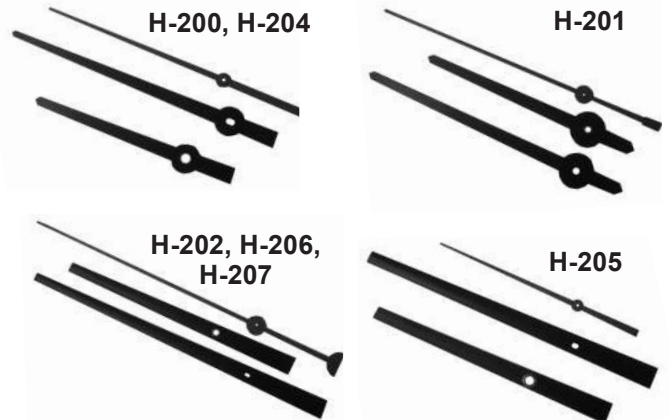

H-200, H-204

H-201

H-202, H-206, H-207

H-205

New Hansen Bottom Set Rod Extenders

Comes with cotter pins to attach.



\$7.95

Item No.	MEM-4R	MEM-5R	MEM-7R	MEM-10R
Length	4-1/2"	5-3/4"	7"	10"

May mix Hansen movements to receive quantity discounts.

Time Only Mini Pendulum Movements

Seiko 3/4" Thin Mini



Specifications:

Case size:
2-1/8"W x 4"H x 3/4"D
Shaft diameter: 5/16"
Standard 'I' shaft.
Rear hand set knob.
Battery: 1 'AA' (not included)
Includes 16" adjustable pendulum with your choice of a 2-1/8", 2-3/4", or 3-1/2" bob upon request.
Includes mounting hardware.
Hands sold separately.
Hangers available upon request.

Runs up to a 27" battery pendulum.

Item No.	Threaded Shaft Length	Overall
MTP-12S	5/16"	5/8"
MTP-12L	11/16"	1"

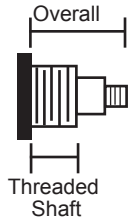

1	3	6	12	30+
\$12.95	\$12.75	\$12.50	\$12.25	\$11.95

New Direct Import Our Lowest Priced Thin Mini



Specifications:

Case size:
2-1/8"W x 4-1/4"H x 3/4"D
Shaft diameter: 5/16"
Standard 'I' shaft.
Rear hand set knob.
Battery: 1 'AA' (not included)
Includes 16" adjustable pendulum with your choice of a 2-1/8", 2-3/4", or 3-1/2" bob upon request.
Includes mounting hardware.
Hands sold separately.

Runs up to a 27" battery pendulum.

Item No.	Threaded Shaft Length	Overall
MTP-14S	5/16"	5/8"
MTP-14M	1/2"	3/4"

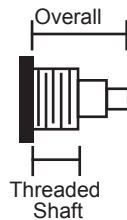

1	3	6	12	30+
\$7.95	\$7.75	\$7.50	\$7.25	\$6.95

U.S. Made Takane Thin Mini



Specifications:

Case size:
2-1/8"W x 3-5/8"H x 7/8"D
Shaft diameter: 5/16"
Standard 'I' shaft.
Rear hand set knob.
Battery: 1 'AA' (not included)
Includes 16" adjustable pendulum with your choice of 2-1/8", 2-3/4" or 3-1/2" bob upon request.
Includes mounting hardware.
Hands Sold Separately.
Hangers available upon request.

Runs up to a 23" battery pendulum.

Item No.	Threaded Shaft Length	Overall
MTP-10XS	3/16"	1/2"
MTP-10S	5/16"	5/8"
MTP-10M	7/16"	3/4"
MTP-10L	11/16"	1"
MTP-10XL	15/16"	1-1/4"

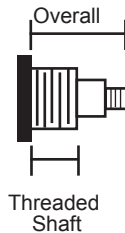

1	6	12	30+
\$8.95	\$8.50	\$8.25	\$7.95

Takane Dual Action Pendulum Movement

For Novelty Clocks with Upper Rocker Platform



Specifications:

Made in the U.S.A.
Case size: 2-1/8"W x 4"H x 7/8"D
Rocker platform: 1/2"W with two 13/16" mounting studs.
Stands 1/2" above movement.
Shaft diameter: 5/16"
Threaded shaft length: 11/16"
Overall shaft length: 1"
Rear hand set knob.
Battery: 1 'AA' (not included)
Includes 16" adjustable pendulum with your choice of 2-1/8", 2-3/4" or 3-1/2" bob upon request
Includes mounting hardware.
Hands sold separately.

Item No. **MTP-16**

Runs up to a 23" battery pendulum.

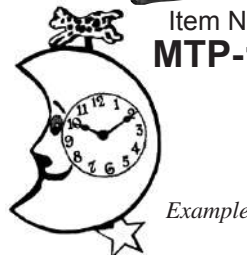

Example

1	3	6+
\$12.95	\$11.95	\$10.95

Hands H-01 thru H-46 on pages 28-31, 20¢ a pair with movement purchase.

May mix styles and shaft lengths to receive quantity discounts.

Recordable & Westminster or Whittington Chime Movements

Just think! A clock that plays any recording you program on the hour! Record your favorite pet, children or grandchildren; favorite song, nature sounds or business advertisement. Record holiday or special occasion greetings; a loving message, joke or funny sound. Car, train, fire engine or police siren. Wise sayings, scripture verses, appointment reminders and much more. Anything your imagination can think of! Comes with a built-in microphone or use the auxiliary microphone jack for high quality recording for 10 seconds of recording time. Plays your personal recording or Westminster or Whittington chimes on the hour only then strikes the hour. Increased volume level for a louder sound than most movements. Auto night shut-off between 11pm and 7am, or chime shut-off options. Complete with instructions for easy operation.

Non-Pendulum Movement



Item No.
MTR-04

Case Size:
2-1/4"H x 2-1/4"W x 5/8"D

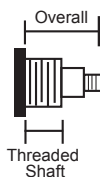

Specifications:

Shaft diameter: 5/16" (8mm)
Threaded shaft length: 1/2"
Overall shaft length: 13/16"
Rear hand set knob.

Battery: 1 'AA' (not included). Includes mounting hardware. Hands sold separately.

Recordable/Chime Module Size:

3-1/4"H x 2-7/16"W x 1-1/2"D
Volume control knob.
2" diameter speaker.
1/8" auxiliary microphone jack.
12" long wires between movement and module.
2 Screw holes for mounting to case.
Battery: 2 'AA' (not included)

MTR-05 comes with a 16" adjustable pendulum.

Choice of a 2-1/8", 2-3/4", or 3-1/2" bob upon request.
Built-in hanger.

Pendulum Movement



Item No.
MTR-05

Case Size: 5-1/2"H x 2-3/8"W x 1-1/4"D
Runs up to a 32" battery pendulum.

1	3	6	12+
\$29.50	\$28.50	\$27.95	\$27.50



1	3	6	12+
\$30.50	\$29.50	\$28.95	\$22.50

Hands **H-01** thru **H-46** on pages 28-31, 20¢ a pair with movement purchase.

New Time Only Pendulum Movement with Press-On Hands



Specifications:

Case size: 2-1/8"W x 4-1/4"H x 3/4"D

Threaded shaft diameter: 5/16"
Threaded shaft length: 5/16"
Overall shaft length: 9/16"
Press-on handshaft.

Rear hand set knob.
Battery: 1 'AA' (not included)
Includes 16" adjustable pendulum with your choice of a 2-1/8", 2-3/4", or 3-1/2" bob upon request.
Includes mounting hardware.
Hands sold separately.

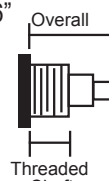

Item No. **MTP-17S**

1	3	6	12	30+
\$9.95	\$9.50	\$9.25	\$8.95	\$8.50

BLACK ONLY. Hands 20¢ pr. with movement purchase.

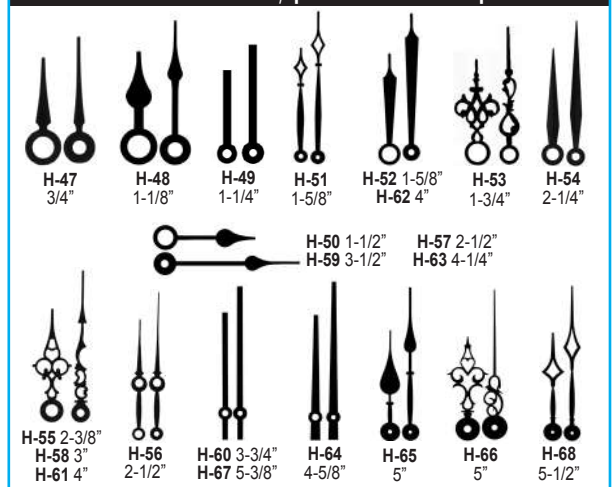

May mix with movements on page 16 to receive quantity discounts.

Chime Movements

Now
Direct Import

Quartz Mechanical Strike Bim Bam

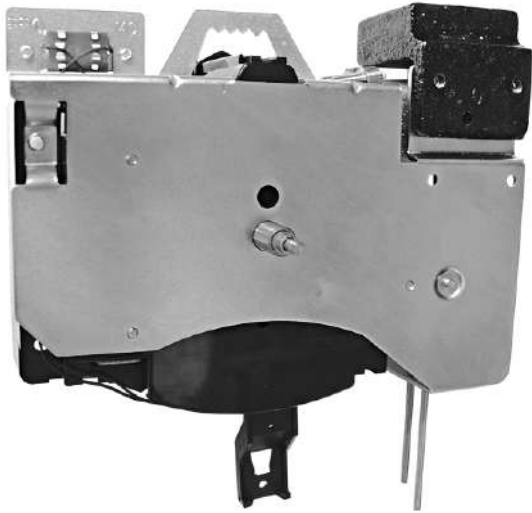

Can be used With or Without Pendulum. Runs up to a 34" Pendulum.

Great for wall or mantle clocks. Bim Bam strike every hour and half hour, with full count on the hour. Two hammers strike 2 copper chime rods mounted in a cast iron block.

Specifications:

Case size: 5-7/8"W x 4-1/2"H x 1-7/8"D
 Chime rod drop: 2-1/2" below case
 Threaded shaft length: 3/8"
 Overall shaft length: 7/8"
 Shaft diameter: 5/16"
 Rear On/Off switch for strike
 Battery: 1 'D' (not included)
 16" adjustable pendulum. Choice of
 2-1/8", 2-3/4" or 3-1/2" bob upon request
 Includes mounting hardware. Hands sold separately
 Does not accommodate a sweep second hand

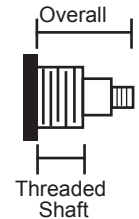

1	3	6+
\$74.95	\$73.95	\$69.95

Item No.
MQB-496

Hands H-01 thru H-46 on pages 28-31, 20¢ a pair with mvmt. purchase.

Non-Pendulum Movement



Case Size: 3"W x 3-7/8"H x 1-1/4"D

4/4 Westminster Chime

Features:

Chimes: 1/4 of the chime at 15 min., 1/2 of the chime at 30 min., 3/4 of the chime at 45 min. and a full chime & counting strike on the hour.

Specifications:

Shaft diameter: 7/16"
 Rear hand set knob.
 Battery: 1 'C' (not included)
 Attached, enclosed tube speaker
 Includes mounting hardware
 Hands sold separately. Hangers available upon request

Pendulum movements come with a 16" adjustable pendulum.
 Choose from a 2-1/8", 2-3/4" or 3-1/2" bob upon request.



Pendulum Movement



Case Size: 3"W x 4-9/16"H x 1-1/4"D

Runs up to a 29" pendulum.

Item No.	Threaded Shaft Length	Overall Length
MWC-2506XS <i>New</i>	5/16"	5/8"
MWC-2506S	7/16"	3/4"
MWC-2506L	11/16"	1"
MWC-2506XL <i>New</i>	15/16"	1-1/4"

1	6	12+
\$22.95	\$21.95	\$20.95

Hands H-01 thru H-46 on pages 28-31, 20¢ a pair with movement purchase.

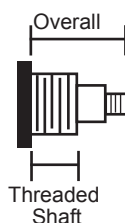

Item No.	Threaded Shaft Length	Overall Length
MWC-2508XS <i>New</i>	5/16"	5/8"
MWC-2508S	7/16"	3/4"
MWC-2508L	11/16"	1"
MWC-2508XL	15/16"	1-1/4"

1	6	12+
\$26.95	\$25.95	\$24.95

New and Improved

High Torque Triple Chime Movement

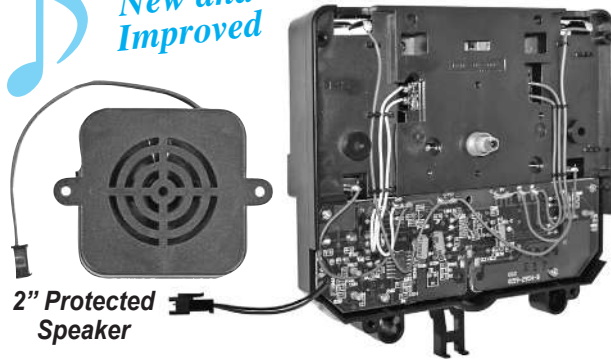

2" Protected Speaker

With Light Sensor Night Shut-off

**Beautiful Tubular Chime Sound!
Best sound of any movement!**

Specifications:

Standard 'I' shaft hand movement
Case size: 4-9/16"W x 4-5/16"H x 1-1/4"D.
Threaded shaft diameter: 5/16".
Rear hand set knob & movement setting controls.
Speaker: detached with 2-1/2" lead wires
Does not mount to back of movement
Pendulum: 16" long, adjustable.
Choose 2-1/8", 2-3/4" or 3-1/2" bob upon request.
Batteries: 2 'C' (not included)
Includes mounting hardware
Hands sold separately.

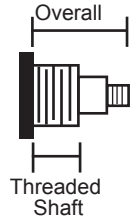

Item No.	Shaft Length	Overall
MPC-500S	3/8"	11/16"
MPC-500M	9/16"	13/16"
MPC-500L	11/16"	1"

Hands H-01 thru H-46 on pages 29-32
20¢ a pair with movement purchase.

1	3	6+
\$39.95	\$37.95	\$36.95

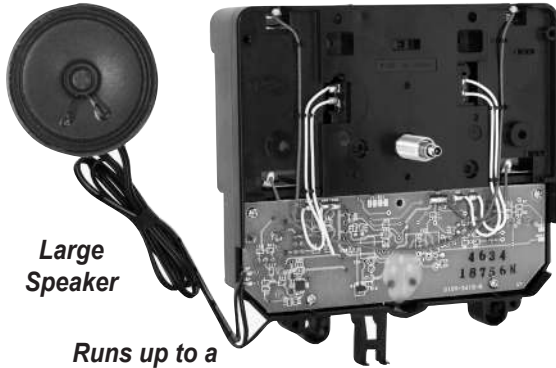

Large Speaker

Runs up to a 20" battery pendulum.

Kit

Speaker wires need to be soldered to movement where marked on Circuit board.

New Direct Import!

Hands H-01 thru H-46 on pages 29-32
20¢ a pair with movement purchase.

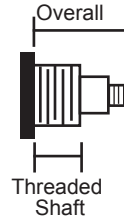

Features:

4x4 Westminster - chime + strike on the hour. 1/4, 1/2, 3/4 chime at 15, 30 & 45 min.
4x4 Ave Maria - chime + strike on the hour. 1/4, 1/2 & 3/4 chime at 15, 30 & 45 min.
Westminster + striking on the hour only
Bim Bam count strike on the hour only
Four sound on/off choices
Sound demonstration button
Volume control
Night shut-off lever between the hours of 11pm-5:45am

Item No.	Shaft Length	Overall
MPC-510M	9/16"	13/16"

1	3	6+
\$35.00	\$33.00	\$32.00



Press-On Hands Movement



Large 3" Speaker

Hands H-58 thru H-68
20¢ a pair with movement purchase.

Item No.	Shaft Length	Overall
MPC-500XS	5/32"	7/16"

1	3	6+
\$44.50	\$43.50	\$42.50

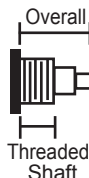

BLACK ONLY. Hands 20¢ pr. with movement purchase.

H-47 3/4" H-48 1-1/8" H-49 1-1/4" H-51 1-5/8" H-52 1-5/8" H-62 4" H-53 1-3/4" H-54 2-1/4"

H-50 1-1/2" H-57 2-1/2" H-59 3-1/2" H-63 4-1/4"

H-55 2-3/8" H-58 3" H-61 4" H-56 2-1/2" H-60 3-3/4" H-64 4-5/8" H-65 5" H-66 5" H-68 5-1/2"

May mix styles & shaft lengths to receive quantity discounts.

Seiko Westminster & Whittington 4/4 Chime Pendulum Movement

Runs up to a 18" battery pendulum.

Features:

Westminster or Whittington Chimes. Chimes every quarter hour with counting strike on the hour. Volume control.
Automatic night silence between 11pm to 5:45am.

Specifications:

Case size: 3-1/4"W x 4-1/2"H x 1"D (3-3/4"W x 4-1/2"H x 1-3/4"D with speaker attached)
Shaft diameter: 5/16" (8mm)
Rear hand set knob
Battery: 1 'C' (not included)
Detached 2-1/4" speaker with 12" pigtail wires. Can also be mounted to back of movement
Includes mounting hardware
Includes 16" adjustable pendulum. Choice of a 2-1/8", 2-3/4", or 3-1/2" bob upon request
Hands Sold Separately

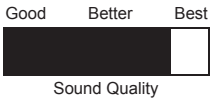
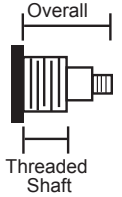

Item No.	Threaded Shaft Length	Overall Length
MPC-240S	3/8"	5/8"
MPC-240L	13/16"	1-1/8"

1	3	6	12+
\$32.95	\$31.95	\$31.50	\$30.95

Seiko 4/4 Westminster & Whittington Chime

Chimes: Westminster or Whittington every quarter hour then strikes the hour. Automatic night shut-off and Volume control.

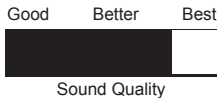
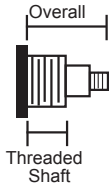

Specifications:

Case size: 3-1/4"W x 2-3/8"H x 1"D (1-7/16"D with speaker attached).
Shaft diameter: 5/16"
Rear hand set knob
Battery: 1 'C' (not included)
Detached 2-1/4" speaker with 12" pigtail wires
Can also be mounted to back of movement
Includes hour & minute hands and mounting hardware
Sweep second hand is extra

Item No.	Threaded Shaft Length	Overall Length
MPC-150S	5/16"	5/8"
MPC-150L	13/16"	1-1/8"

1	3	6	12+
\$29.50	\$28.95	\$26.95	\$25.95

6 Melody Movement

Chimes at the top of the hour only. No hour strike.

Chimes include:
Westminster,
Ave Maria,
Over the Rainbow,
Rudolph the Red Nose Reindeer,
Try to Remember and Happy Birthday



Item No.
MTC-06

Specifications:

Case size: 3"W x 3-7/8"H x 1-3/16"D
Shaft diameter: 7/16"
Threaded shaft length: 3/8"
Overall shaft length: 5/8"
Rear hand & chime set knobs
Battery: 1 'C' (not included)
Enclosed tube speaker
Includes mounting hardware
Hands sold separately
Hangers available upon request
Back turn button changes melody

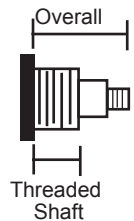

1	3	6	12+
\$16.50	\$15.50	\$14.95	\$14.50

Hands H-01 thru H-46 on pages 29-32, 20¢ a pair with movement purchase.

May mix styles & shaft lengths to receive quantity discounts.

German High Torque Bim Bam/Westminster Chime Pendulum Movement

New Direct Import

Runs up to a 32" battery pendulum - Powers up to 17-1/2" Hands



Features:

Bim Bam chimes every hour and half hour with full count on the hour. Westminster chimes every quarter hour with counting strike on the hour. Volume control. Night shut off switch. German made high quality.

Specifications:

Case size: 2-7/8"W x 4-1/4"H x 1-1/4"D
 3" diameter speaker with 5-1/2" wire length.
 Shaft diameter: 5/16"
 Rear hand set knob
 Collar sleeve, standard 'I' shaft
 Battery: 2 'AA' (not included)
 Includes mounting hardware
 Includes 16" adjustable pendulum with your choice of 2-1/8", 2-3/4" or 3-1/2" bob upon request
 Hands sold separately
 Built in hanger

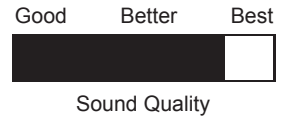

Hands **H-01** thru **H-46** on pages 28-31, 20¢ a pair with movement purchase.

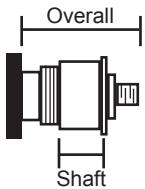

Item No.	Collar Sleeve	Overall Length
MPC-320S	3/16"	5/8"
MPC-320M	5/16"	13/16"

1	3	6+
\$59.95	\$57.95	\$55.95

New Smallest Pendulum Movement

Time Only

Fits some Timeworks clocks that have a small hole above the six.



Specifications:

Size: 3-1/4"H x 1-7/8"W x 1"D
 Shaft diameter: 5/16"
 Threaded shaft length: 1/8"
 Overall length: 1/2"
 Battery: 1 'AAA' (not included)
 Runs up to 5" hands
 Rear hand set.
 Has upper rocker feature

Available with miniature 3" pendulum with a 1" bob

PM-42 \$2.50

Item No. **MTP-18**

Press on hands **H-47** thru **H-68** on page 5, 20¢ a pair with movement purchase.

1	3+
\$10.95	\$8.95

Cuckoo & Westminster Chime Pendulum Movement

Made in Germany. Chimes cuckoo or Westminster on the hour. On/Off switch for cuckoo.

New

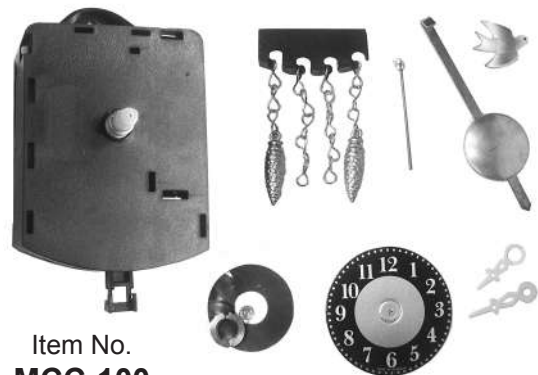

Item No. **MCC-100**

Specifications:

Case size: 2-11/16"W x 3-7/8"H x 1-1/2"D
 Shaft diameter: 5/16"
 Threaded shaft length: 5S/16"
 Overall shaft length: 5/8"
 Battery: 1 'AA' (not included)
 Includes: 2-15/16" pendulum, 1-5/8" paper dial, hour and minute hands, bird, decorative chains and weights, and mounting hardware.

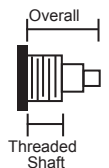

1	3	6+
\$19.95	\$18.95	\$17.95

Trigger/Timekeeping Replacement Movements

For train, bird, cuckoo, 16 melody and many other sound making clocks.

Non-Pendulum



Case size:
2-1/8"W x 2-1/8"H
x 9/16"D

Item No.	Threaded Shaft Length	Overall Length
MSM-800S	1/4"	9/16"
MSM-800M	7/16"	3/4"

1	3	6	12+
\$5.95	\$5.50	\$4.95	\$4.75

Specifications:

Shaft diameter: 5/16"
Rear hand set knob.
Battery: 1 'AA', not included
Easy clip attachment or, the clip can be removed for twisting the wires together, depending on your sound module wire style.
Includes mounting hardware.
Hands sold separately.

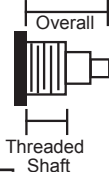

MSP-810 comes with a 16" adjustable pendulum and your choice of 2-1/8", 2-3/4", or 3-1/2" bob upon request.

Pendulum



Item No. **MSP-810**

Case size: 2-1/8"W x 3-1/2"H x 9/16"D
Threaded shaft length: 5/16"
Overall shaft length: 5/8"

1	3	6	12+
\$9.95	\$9.50	\$8.95	\$8.50

Sound Modules

Sound module battery compartment: 2-7/8"L x 1-1/4"W x 7/16"D. Battery: 2 'AA' (not included). 5" lead wires for attachment to movement. 7" wires connect speaker & circuit board to battery compartment & test button.

Westminster Chime

Chimes and strikes at the top of the hour only. Test button.
Size: 2-3/16"W x 2-9/16"H.
Requires 2 'AA' batteries (not included)

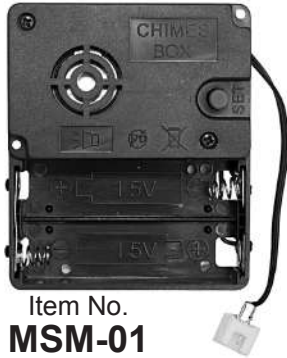

Item No. **MSM-01**

Cuckoo Bird

Item No. **MSM-02**

Plays a combination of forest birds, babbling brooks and cuckoo calls on the hour. Build your own or use as a replacement movement in existing cuckoo clocks. No night shut-off.

16 Melody

Item No. **MSM-03**

Plays a different song every hour then strikes the hour. Melodies include: Cuckoo Waltz, Farmer in the Dell, Fur Elise, Home on the Range, Long Long Ago, A Lover's Concerto, Tranmerci, Weigenlied, Toy Symphony, Old Black Joe, Die Lorelei, Frohlicher Landman, Home Sweet Home, Swan Lake, Hush Baby and Serenade Rampinnt. Automatic night chime shut-off: between 9:05pm to 5:55am.

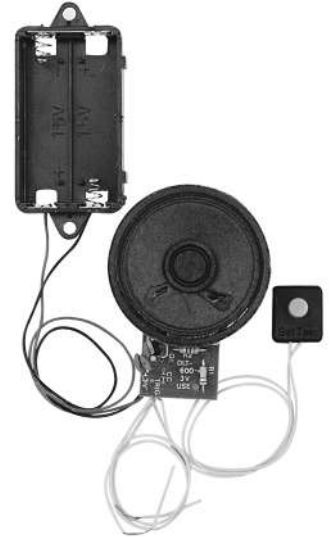

Train

Item No. **MSM-04**

AVAILABLE AGAIN!

Plays 12 different sound combinations, one each hour. A variety of train on track sounds, warning whistles, hissing steam, railroad crossing bells, locomotive bell and more. Size: 2-3/16"W x 2-3/8"H Requires 2 'AA' batteries (not included).



1	3	6+
\$7.95	\$7.50	\$7.00

BLACK ONLY. Hands 20¢ pr. with movement purchase. Measurement is the minute hand length from the center of the hole to the tip.

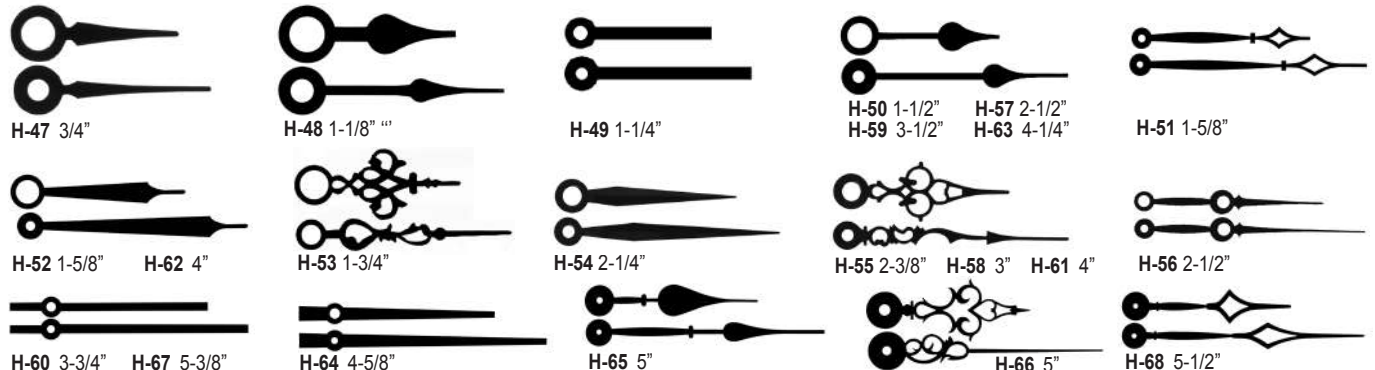

Large Pendulum Drive Mechanism

New and Improved

Heavy Duty. Will run up to a grandfather size lyre pendulum!

Saves money - allows the use of any inexpensive battery movement to run the time, freeing you from the use of expensive mechanical movements. Because the mechanism is top driven you can design clocks where the pendulum is in the open.

Runs up to a 42" lyre pendulum with a 10-1/2" bob.

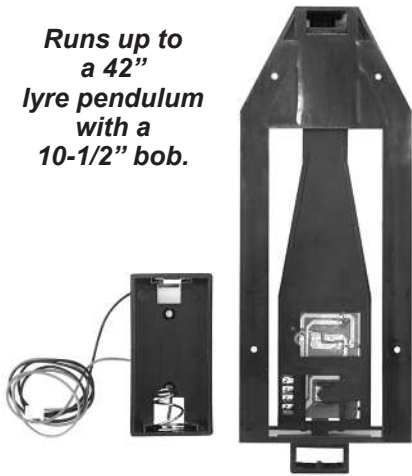

Specifications:

Size: 8-3/8"H x 3"W x 2-1/8"D
 Also great for large or small wall clocks.
 Mounts inside case.
 Pre-drilled mounting holes.
 Requires 2-1/4" depth.
 Detached battery compartment: 1-1/2"W x 2-7/8"H x 1"D
 Easy clip wire attachment.
 14" long wires.
 Battery: 1 'D' (not included)

Item No. **MPD-80**

1	3+
\$16.50	\$16.00

Youngtown Empty Pendulum Case

New Direct Import

More Realistic Pendulum Swing

Converts a 'AA' mini quartz movement into a pendulum movement or drive pendulum alone.

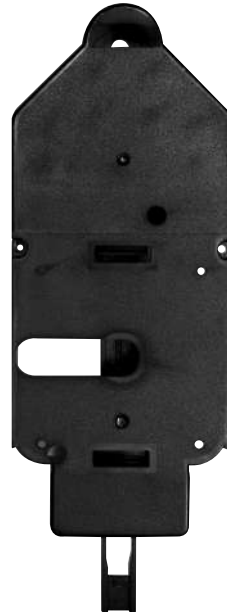

Specifications:

Case Size: 6-1/2"H x 2-3/8"W x 1-1/2"D
 Pendulum does not affect time keeping
 Pendulum hanger slot: 3/16" W

Item No. **MCA-30**

1	6	12	30+
\$8.50	\$8.00	\$7.50	\$7.00

Heavy Duty



Runs up to a 6-1/2" bob lyre pendulum.

Item No. **MCA-25**

1	6	12	30+
\$7.00	\$6.50	\$5.95	\$5.50

New Direct Import

Empty Pendulum Cases

Create Your Own Pendulum Movement

Converts a 'AA' mini quartz movement into a pendulum movement or drive a pendulum alone.
 Pendulum does not affect time keeping.

Specifications:

Case size: 4-3/4"H x 2-3/8"W x 1-1/4"D
 Battery: 1 'AA' (not included)
 Accommodates movements up to 2-1/4" x 2-1/4".

Save time - order on line at:
ronellclock.com

Light Weight



Runs up to a 32" battery pendulum.

Item No. **MCA-10**

1	6	12	30
\$6.50	\$6.00	\$4.95	\$4.50

May mix styles to receive quantity discounts.

Specialty Battery Movement Pendulums

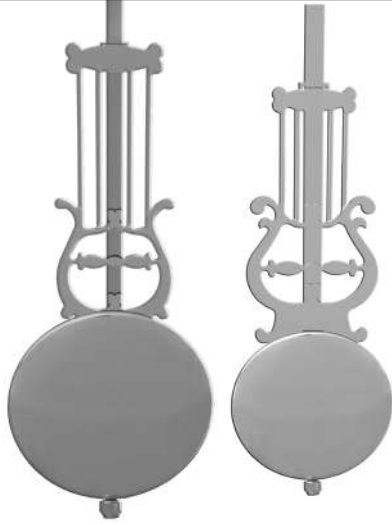

Add charm & elegance to any clock. Your choice of a 4-1/2" or 6" polished brass finish Lyre attachment, a 2-3/4" or 3-1/2" brass finish bob and a double or single hook 16" adjustable brass finish pendulum rod.

Lyre Pendulums

Item No.	Lyre Size	Bob Size	Hook Type	1	6+
PML-42S	4-1/4"	2-3/4"	Single	\$5.25	\$4.95
PML-43S		3-1/2"			
PML-42D	4-1/4"	2-3/4"	Double	\$5.75	\$5.50
PML-43D		3-1/2"			
PML-62S	6"	2-3/4"	Single	\$5.75	\$5.50
PML-63S		3-1/2"			
PML-62D	6"	2-3/4"	Double	\$5.75	\$5.50
PML-63D		3-1/2"			



Antiqued Pendulums

Add an elegant look to your clock. Available in a 2-3/4" or 3-1/2" bob with a 16" adjustable, single or double hook pendulum rod to match.

Bob Size	Item No.	1	6+
2-3/4"	PMB-234A	\$4.25	\$4.10
3-1/2"	PMB-312A	\$4.50	\$4.30

Extra Long 32" Pendulum Rod

For battery movements. Brass finish. Adjustable. In a double or single hook. Comes with your choice of a 2-1/8", 2-3/4" or 3-1/2" bob.



Rod may need to be shortened to run on your movement.

Double Hook **#PMXL-32D**

Single Hook **#PMXL-32S**

Rod & Bob **\$7.50** with Movement **\$6.00**

Lyre Pendulum Attachment



Give your clock a fancier look! Turn any plain rod into a beautiful pendulum. Metal with polished brass or matte black finish. Fits any 1/4" wide metal battery pendulum rod. Slip-on fit. Light weight will not interfere with pendulum swing.

Item No.	Size	1	6+
PMLA-04B (black)	4-1/4"	\$1.25	\$1.00
PMLA-04G (gold)	4-1/4"	\$2.25	\$2.00
PMLA-06G (gold)	6"	\$2.75	\$2.50

Mini Pendulums

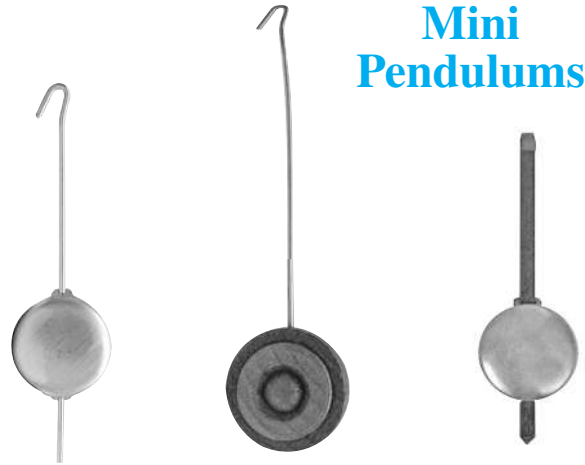

Zappler

Adjustable. 5/8" dia. brass colored bob & 2-5/8" wire rod.

Item No. **PM-39**

\$1.40 ea.

12+ **\$1.00** ea.

Novelty

7/8" dia. brown wooden bob & 7-1/2" wire rod.

Item No. **PM-40**

\$1.40 ea.

12+ **\$1.00** ea.

Novelty

Adjustable. 1" dia. brass colored bob & 3-1/8" brass rod.

Item No. **PM-42**

\$2.50 ea.

12+ **\$2.00** ea.

Wooden Pendulum Sleeve



Create a new, richer look of wood for that old metal battery pendulum rod. Unfinished for painting or staining. Slotted for easy slip-on fit. May be cut to desired length. Lightweight, will not interfere with swing of the pendulum. Size: 12"L x 5/8"W.

Item No. **PMWS-12**

\$2.50 **\$2.30**

Battery Movement Accessories

Battery Movement Covers

These durable black plastic covers protect your mini quartz or thin mini pendulum movement for OUTDOOR use. Gives your desk clock a finished look and helps to reduce/muffle loud tick sound. Fits snugly over the back of the movement.



Fits Movements:
MTW-10XL, 20's
30, 89's & 91,
MSN-23's

Item No.
MAC-218



Fits Movements:
MTD-02, MTW-21,
24, 35's, 40's, 41's
80's, 83 & 84,
MSF-01's - 03

Item No.
MAC-219



Fits Movements:
MTP-10's,
14-17

New

Item No.
MAC-220

1	6	12+
\$1.00	90¢	85¢

May mix styles to receive quantity discounts.

Battery Movement Hardware

Hand Nuts To Fit:

- MEC-12
- MPC-150, 240, 500
- MTC-06; MTP-10 thru 88
- MTR-04, 05; MTW-10XL, 20, 35, 70, 80, 84, 85, 87-90
- MWC-2506, 2507 & 2508



Open Nut #**MHW-01**
Closed Nut #**MHW-03**

10¢ea.

Hand Nuts To Fit:

- MQB-496
- MRC-65
- MTW-21, 24 & 83
- MCN-24
- MTD-01 & 02
- MTH-11

Open Nut #**MHW-02**
Closed Nut #**MHW-04**

10¢ea.

Ronell Direct



5/8" w x .75mm thick. 5/16" hole.
Item# **MHW-12**
7¢ea.

Rubber Washers



1-1/8" w x 1.15mm thick. 7/16" hole.
Item# **MHW-13**
10¢ea.



EXTRA THICK
1-1/2" w x 4.5mm thick. 3/8" hole.
Item# **MHW-14**
18¢ea.

Hex Nuts

For movements with 5/16" (8mm) shaft dia.

For movements with 7/16" (11mm) shaft dia.



1.3cm Dia.
Item# **MHW-08**
12¢ea



1cm Dia.
Item# **MHW-09**
10¢ea.



1.3cm Dia.
Item# **MHW-11**
12¢ea



1.2cm Dia.
Item# **MHW-10**
10¢ea

Brass Washers



1/2" W, 3/32" lip For mvts. with 5/16" (8mm) shafts
Item# **MHW-05**
5¢ea



5/8" W, 3/16" lip For mvts. with 5/16" (8mm) shafts
Item# **MHW-06**
7¢ea



5/8" W, 3/32" lip For mvts. with 7/16" (11mm) shafts
Item# **MHW-07**
10¢ea

Ronell Direct Adhesive Mounting Pads

These double sided adhesive pads are great for mounting movements to dials and clock cases. Now comes in two styles: square or round.



1-7/8" Square

New



1-1/2" Round

Item No. **MMP-100**

Item No. **MMP-150**

1	3	6	12	24	50	100
60¢	55¢	50¢	45¢	30¢	25¢	20¢

May mix styles to receive quantity discounts.

Wall Mount Movement Housing

The housing holds any 2-1/4" square movement. Mounts easily to the wall.

Make Your Own Large Clock!

New



Black



Gold & Silver

Black:
3-3/8" dia. x 1" deep
Gold & Silver:
3-7/8" dia. x 3/4" deep

Item No.	Color	Material	1	3	6+
MMB-01B	Black	Plastic	\$2.99	\$2.79	\$2.60
MMB-01G	Gold	Metal			
MMB-01S	Silver				

Clock Hands

Extra Large Hands

For use on High Torque Movements Only

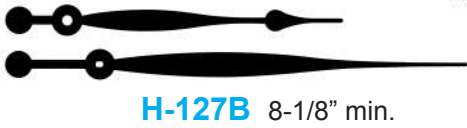

H-127B 8-1/8" min.



H-128B 9-3/8" min.



H-129B 12" min.

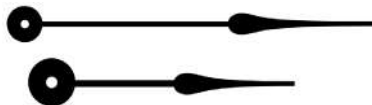

H-130B 7" min.



H-131B 8" min.

H-132B 10" min.

H-133B 17-1/2" min.

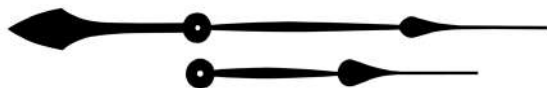

H-134B 10" min.

H-135B 12" min.

H-136B 13-3/4" min.

H-137B 17-3/4" min.

Hands are measured from the center of the hole to the tip of the minute hand.
All hands are in Black only.

Hands **NOT** Shown Actual Size



H-138B 12-3/4" min.

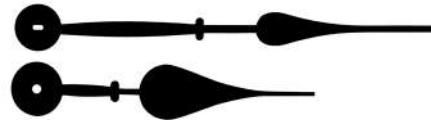

H-140B 11-1/4" min.

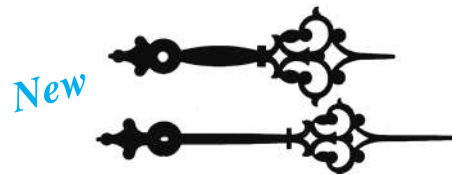

New

H-141B 8" min.

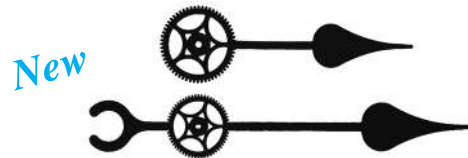

New

H-142B 8-1/2" min.

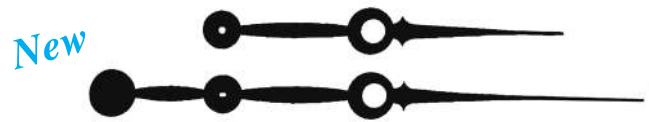

New

H-143B 14-1/2" min.



New

H-144B 7-5/8" min.

Item No.	Size	1	6	12	30+
H-127B	8-1/8"	\$4.95	\$4.75	\$4.50	\$4.25
H-128B	9-3/8"	\$5.95	\$5.75	\$5.50	\$5.25
H-129B	12"	\$6.95	\$6.75	\$6.50	\$6.25
H-130B	7"	\$2.60	\$2.45	\$2.35	\$2.25
H-131B	8"	\$5.45	\$5.10	\$4.75	\$4.50
H-132B	10"	\$5.75	\$5.35	\$4.95	\$4.65
H-133B	17-1/2"	\$7.95	\$7.45	\$6.95	\$6.45
H-134B	10-7/8"	\$6.25	\$5.75	\$5.60	\$5.25
H-135B	12"	\$6.90	\$6.50	\$6.10	\$5.75

Item No.	Size	1	6	12	30+
H-136B	13-3/4"	\$9.15	\$8.50	\$7.90	\$7.35
H-137B	17-3/4"	\$9.25	\$8.60	\$8.00	\$7.45
H-138B	12-3/4"	\$9.95	\$9.35	\$8.45	\$7.85
H-140B	11-1/4"	\$6.95	\$6.45	\$5.95	\$5.45
H-141B	8"	\$5.45	\$5.10	\$4.75	\$4.50
H-142B	8-1/2"	\$5.95	\$5.75	\$5.50	\$4.95
H-143B	14-1/2"	\$9.15	\$8.50	\$7.90	\$7.35
H-144B	7-5/8"	\$5.45	\$5.10	\$4.75	\$4.50

**Special Purchase
While Supply
Lasts!**

Speciality & Extra Large Hands

Hands are measured from the center of the hole to the tip of the minute hand.

Hands NOT Shown
Actual Size

H-145A 2-3/4" min.

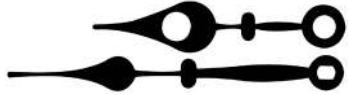

H-147BL
5-3/4" min.



H-146BL
3-3/4" min.

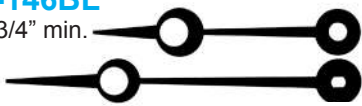

H-150A
5-3/4" min.



H-148B
6-1/2" min.

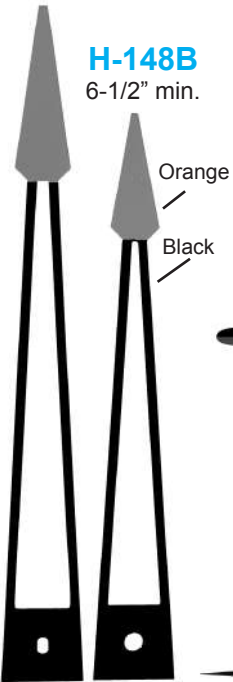

H-151B
8-3/4" min.

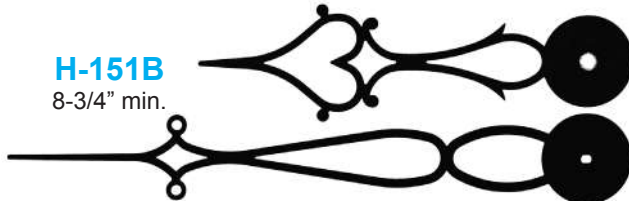

H-152B
9" min.

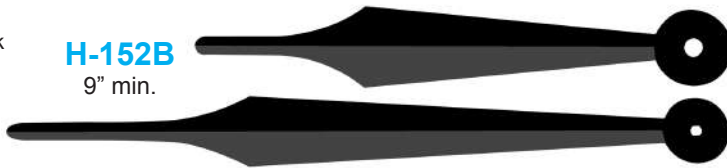

H-153B
9" min.



H-155A
10-1/2" min.



H-149B
6-1/4" min.

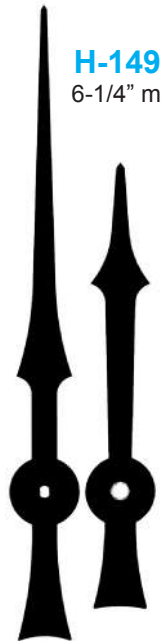

H-157B
24" min.



H-154B
10" min.
H-156B
14" min.

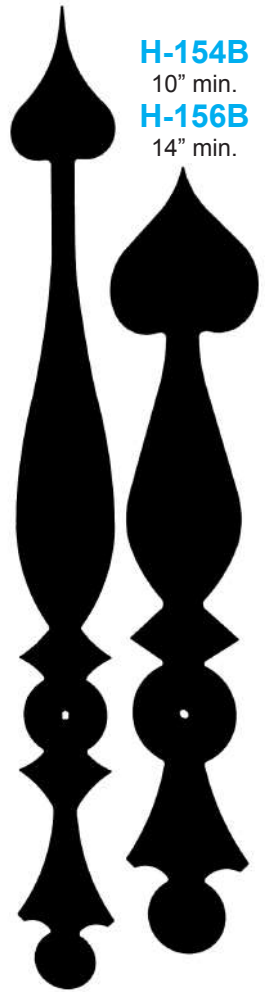

Item	Size Minute Hand	Color/Finish	1	6	12	30+
H-145A	2-3/4"	Antiqued	\$1.00	90¢	80¢	70¢
H-146BL	3-3/4"	Dark Blue				
H-147BL	5-3/4"	Blue w/Red Oval on Min. Hand	\$4.00	\$3.75	\$3.50	\$3.25
H-148B	6-1/2"	Black w/Orange Tip				
H-149B	6-1/4"	Black w/Brushed Finish				
H-150A	5-3/4"	Antiqued	\$4.45	\$4.10	\$3.75	\$3.50
H-151B	8-3/4"	Black				
H-152B	9"	Black				
H-153B	9"	Black				
H-154B	10"	Black	\$5.75	\$5.35	\$4.95	\$4.65
H-155A	10-1/2"	Antiqued	\$6.25	\$5.75	\$5.50	\$5.25
H-156B	14"	Black	\$14.00	\$13.50	\$13.00	\$12.50
H-157B	24"	Black	\$19.95	\$19.50	\$18.90	\$18.35

May mix & match hands to receive quantity discounts.

Made in U.S.A

Battery Movement Hands

All Hands Shown Actual Size

For Standard 'I' Shaft Movements

Hands H-01 thru H-46 are 20¢ a pair with movement purchase. You may choose the style, size and color you prefer. Hands may be purchased separately without a movement and are priced below.

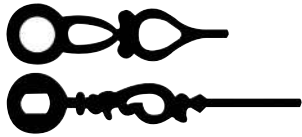

H-01G

Gold Only, 1-3/8" min.

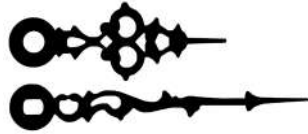

H-02G

Gold Only, 1-3/8" min.

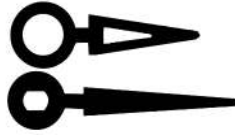

H-03G

Gold Only, 1" min.

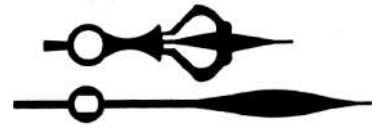

H-04G

Gold Only, 1-9/16" min.

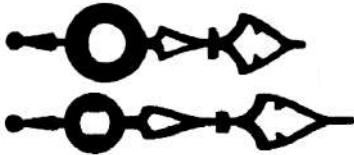

H-05G

Gold Only, 1-3/8" min.



H-06G Gold **H-06B** Black
1-9/16" min.



H-07G Gold **H-07B** Black
2-3/8" min.

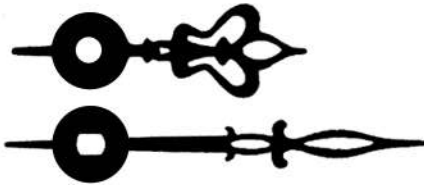

H-08G Gold **H-08B** Black
1-3/4" min.

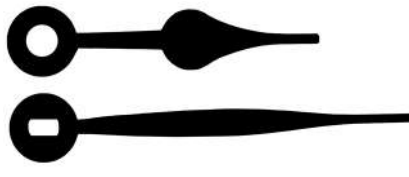

H-09G Gold **H-09B** Black
1-15/16" min.



H-10G Gold **H-10B** Black
2" min.



H-11G Gold **H-11B** Black
2-1/4" min.

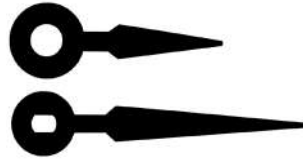

H-12G Gold **H-12B** Black
1-1/2" min.

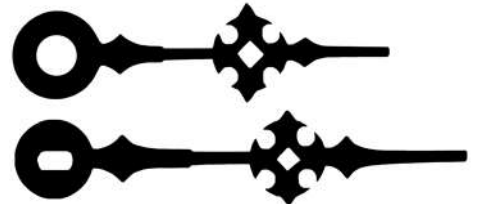

H-13G Gold **H-13B** Black
2-1/16" min.

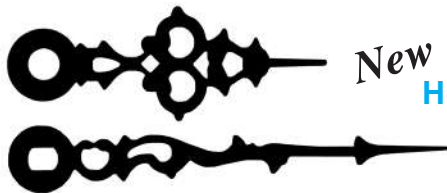

New

H-41G Gold Only
2-1/8" min.

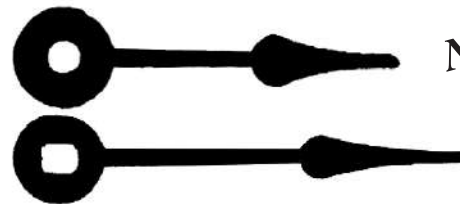

New

H-40G Gold
H-40B Black
2-3/8" min.

Prices are per pair.

1-11	12-29	30-49	50-100+
75¢	50¢	45¢	40¢

Hand Measurement Guide



Measurement is from the center of the mounting hole to the tip of the minute hand.

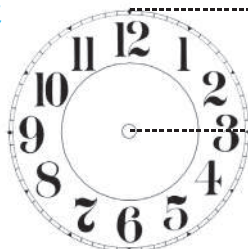

Minute Hand Length
Time Ring Dia.

Sweep Second Hand Measurement Guide

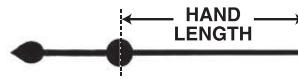

Second hand should be the same length or slightly smaller than the minute hand.

Mounting Hole Dimensions

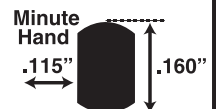

All Hands Shown
Actual Size



H-14G Gold



H-14B Black
3" min.



H-15G Gold Only
2-7/8" min.



H-16G
Gold Only
2-9/16" min.

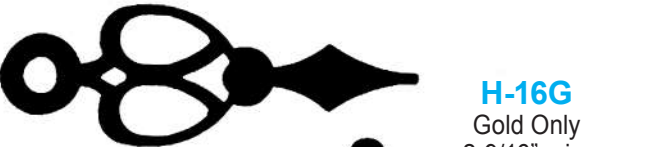

H-17G Gold
H-17B Black
3" min.

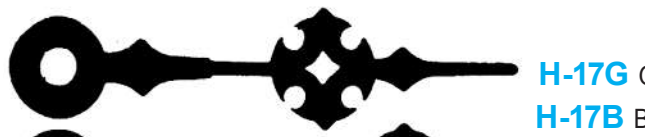

H-18G Gold
H-18B Black
3" min,

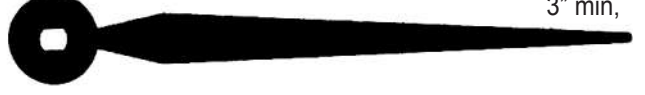

H-19G Gold
H-19B Black
2-3/4" min.

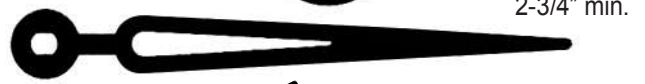
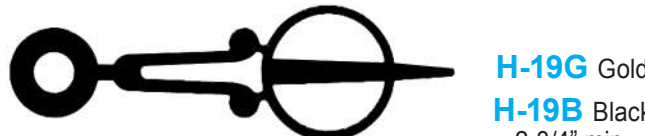

H-20G Gold
H-20B Black
3-1/8" min.



H-21G Gold
H-21B Black
3-1/16" min.

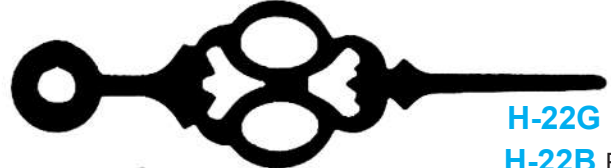
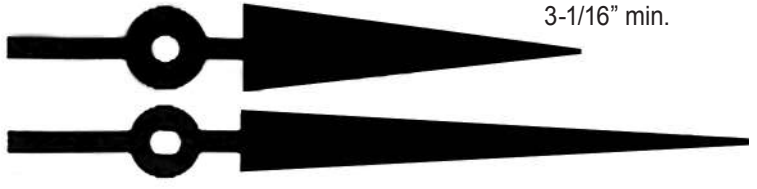

H-22G Gold
H-22B Black
3-3/8" min.

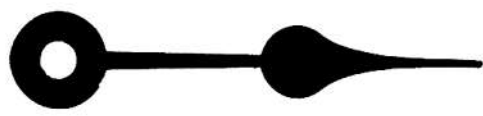
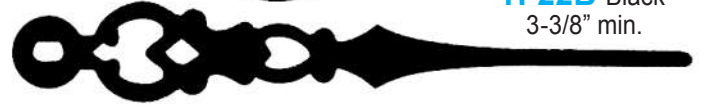

H-23G Gold
H-23B Black
2-7/8" min.



H-24G Gold
H-24B Black
3-1/4" min.



H-25G Gold
H-25B Black
3-1/16" min.

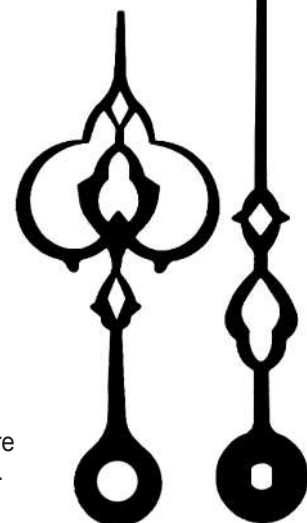

H-26G
Gold Only
3-11/16" min.

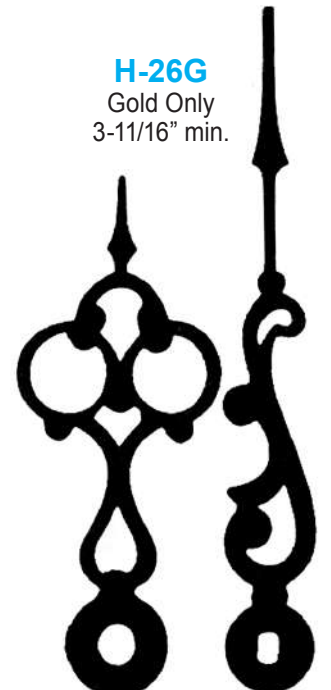

1-11	12-29	30-49	50-100+
75¢	50¢	45¢	40¢

Prices are per pair.

May mix & match hands to receive quantity discounts.

**All Hands Shown
Actual Size**

H-27G Gold
H-27B Black
3-3/8" min.



H-44G Gold
H-44B Black
2-5/8" min.

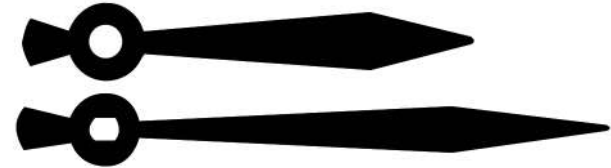

H-36G Gold
H-36B Black
3-1/2" min.

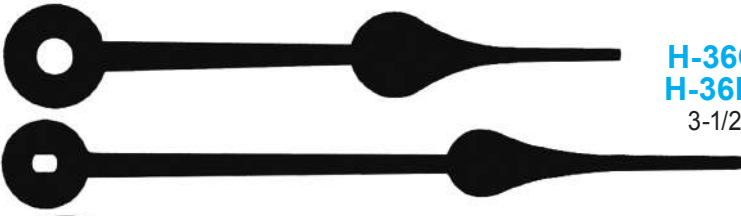

H-28G Gold
H-28B Black
4" min.

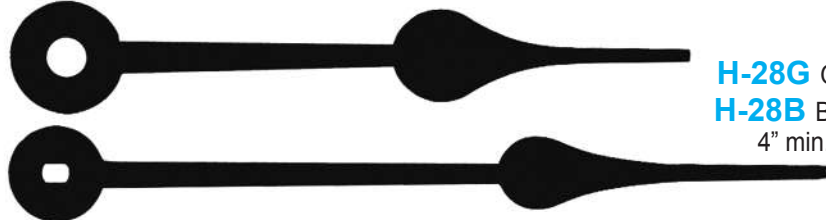

H-37G Gold
H-37B Black
4-1/2" min.

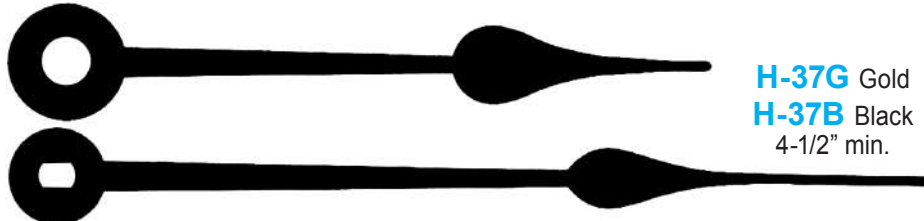

H-35G
Gold Only
3-3/4" min.

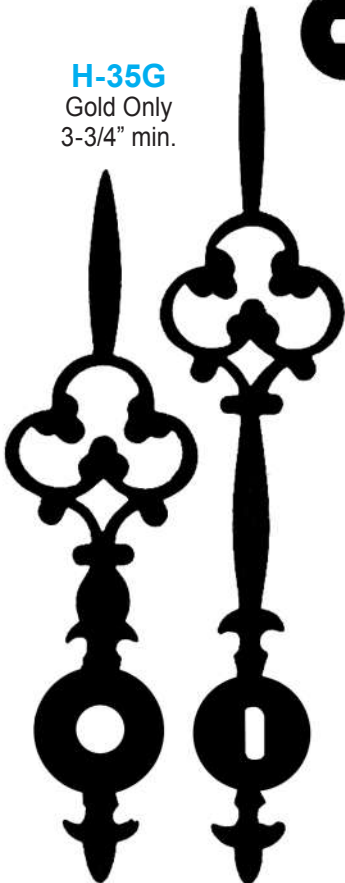

Hands **H-01** thru **H-46** are 20¢ a pair with movement purchase. You may choose the style, size, and color you prefer. Hands may be purchased separately without a movement and are priced below.

H-29G Gold
H-29B Black
3-1/4" min.

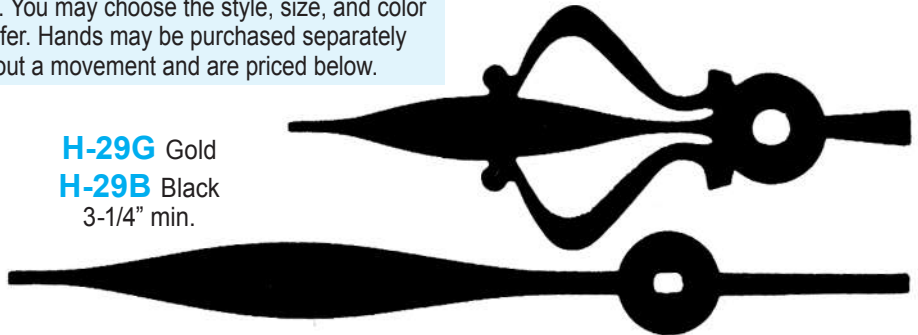

H-31G Gold
H-31B Black
4" min.



H-33G Gold
H-33B Black
4-1/4" min.

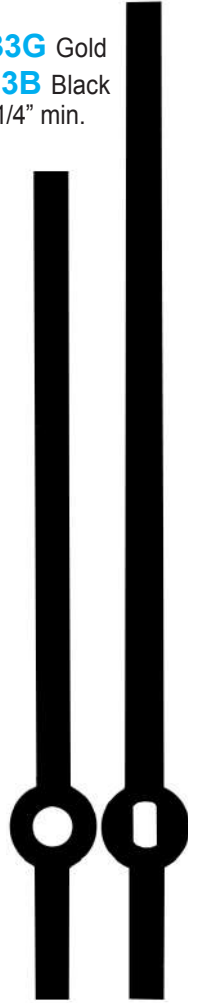

H-38G Gold
H-38B Black
5-1/4" min.

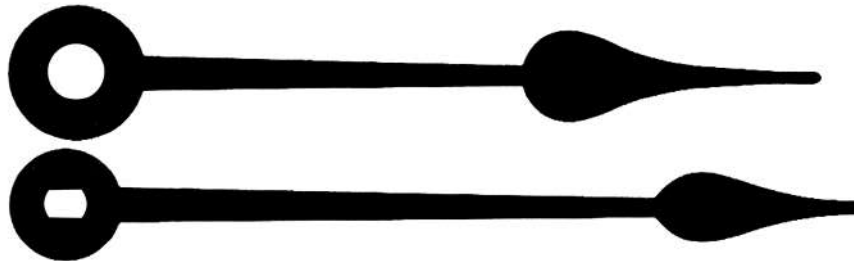

H-42B Black
6" min.

1-11	12-29	30-49	50-100+
85¢	70¢	60¢	55¢

Prices are per pair.

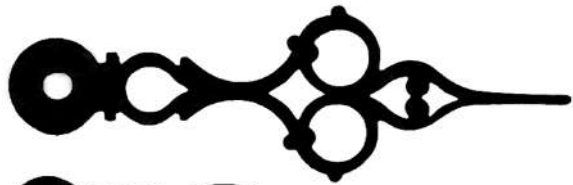

H-32G Gold
H-32B Black
4-3/4" min.



H-34G Gold
H-34B Black
4-1/8" min.

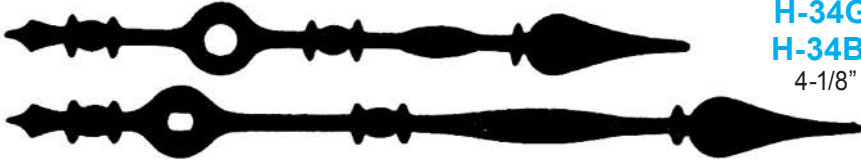

H-39B Black Only
3-7/8" min.



H-45G Gold
H-45B Black
3-5/8" min.



H-46G Gold Only
5-3/4" min.

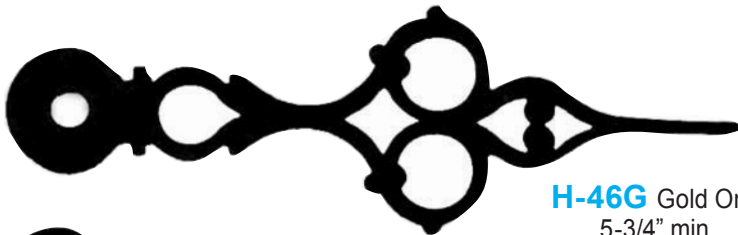

H-30G
Gold Only
4-3/8" min.



Hands are **NOT**
Shown Actual Size

Hands H-01 thru H-46 are 20¢ a pair with movement purchase. You may choose the style, size, and color you prefer. Hands may be purchased separately without a movement and are priced below.

1-11	12-29	30-49	50-100+
85¢	70¢	60¢	55¢

Prices are per pair.

Fancy English Battery Movement Hands

Give your clock that special touch with these beautiful hands, imported from England. Lazer cut, brass finish, extra fancy. Fits all of our quartz battery movements. **SORRY! English hands are ONLY sold separately.** They are **NOT** included for 20¢ with movement purchase.



Item No. **H-77**
1-5/8" min.

Item No.	1	3	6+
H-77	\$2.00	\$1.75	\$1.50
H-78	\$2.25	\$2.00	\$1.75



Item No. **H-78**
2-1/2" min. 4" overall length

All prices are subject to change without notice.

May mix & match hands to receive quantity discounts.

Sweep Hands

Hands NOT Shown Actual Size

S-01G Gold **S-01B** Black **S-01R** Red 1"

S-02G Gold **S-02B** Black **S-02R** Red 1-7/16"

S-03G Gold **S-03B** Black **S-03R** Red 1-13/16"

S-04G Gold **S-04B** Black **S-04R** Red 2-3/8"

S-05G Gold **S-05B** Black **S-05R** Red 2-3/4"

S-06G Gold **S-06B** Black **S-06R** Red 3-1/2"

S-11G Gold Only 3"

1-11	12-29	30-49	50+
60¢	50¢	40¢	35¢

PROMOTIONAL SWEEPS

LIMITED INVENTORY!

S-20B Black 1-1/4"

S-21G Gold 1-1/2"

S-22B Black **S-22S** Silver **S-22U** Unfinished 2"

S-23R Red **S-23S** Silver 2-1/4"
S-29B Black **S-29G** Gold 3"

S-24G Gold 2-1/4"



S-26B Black 2-1/2"

S-27W White **S-27B** Black 2-1/2"

S-25G Gold 3-1/4"

May mix & match sweeps to receive quantity discounts.

1	12	50+
50¢	40¢	30¢

Sweep Second Hand Measurement Guide

Second hand should be the same length or slightly smaller than the minute hand.

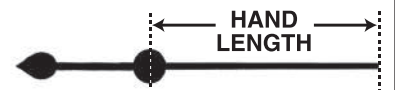

S-08G Gold **S-08B** Black **S-08R** Red 4-1/2" hand length 6-3/8" overall

S-12B Black **S-12S** Silver 4-1/2" hand length 7-3/8" overall

S-09B Black 5-1/4" hand length 8-9/16" overall

S-07R Red 6" hand length 9-1/2" overall **\$2.75**

Note: **S-07R** and **S-11R** will only work on MTW-84, MTW-90 and MTW-91 movements

Large Sweep Second Hands

NOT Shown Actual Size

1	12	50+
\$1.25	\$1.05	95¢

New Extra Long Sweep Hand S-11R Red **\$6.00**

10" hand length 16" overall

May mix & match sweeps to receive quantity discounts.

PROMOTIONAL SWEEPS

LIMITED INVENTORY!

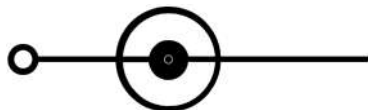

S-30R Red 1-1/2"



S-31G Gold 2"



S-32G Gold 3-1/2"



S-33G Gold with Black Circle 3-1/2"



S-34S Silver 4-1/4"



S-35B Black 4-1/2"

May mix & match sweeps to receive quantity discounts.

1	12	50+
50¢	40¢	30¢

French Hands

Metal, black finish. Round hour hand hole with 4.5mm dia. bushing, square minute hand hole with 2mm bushing.



Minute Hand Size	Hour Hand Size	Item No.	Price
1-1/2"	1-1/8"	H-321	\$5.95 pr.
1-5/8"	1-5/16"	H-322	
2-1/8"	1-11/16"	H-324	

American Hands

Square minute: 3mm. Oblong minute: 4 x 2.5mm. Hour Sleeve Bushing: 5mm
Hands are measured from the center of the hole to the tip.

\$2.75 pr.

Hands **NOT** Shown Actual Size

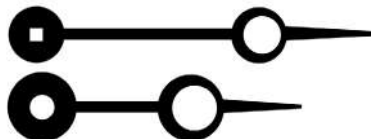

Moon Style

5-3/8" min - 4-1/4" hour.

H-340S Square Hole

H-340L Oblong Hole

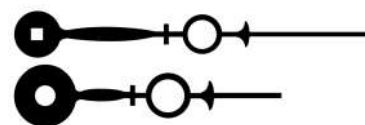

OG Hands

3-1/2" min - 2-1/2" hour.

H-341S Square Hole

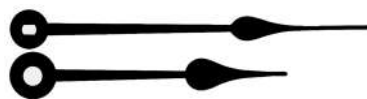

Antique Reproduction

5-1/2" min - 4-7/8" hour.

H-360S Square Hole

H-360L Oblong Hole



Regulator "A"

5-1/2" min - 4" hour.

H-361S Square Hole

Calendar Hand



For mechanical movements. Black. 5-3/4" long. 7-5/8" overall length. 8.95mm hole dia. Metal.

Item No. **H-350**

\$4.00

Hole Measurements - Square Minute: 3mm, Oblong Minute: 3.5 x 2.5mm, Hour Bushing: 5.45mm

Maltese Style



\$2.00 pr.
6+ **\$1.75** pr.

Minute Hand Size	Minute Hole	Item No.
2-1/4"	Oblong	H-107L
2-1/4"	Square	H-107S
2-1/2"	Oblong	H-108L
2-1/2"	Square	H-108S

Moon Style

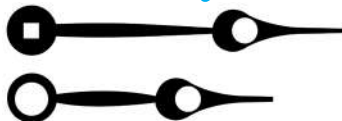

\$2.00 pr. 6+ **\$1.75** pr.

Minute Hand Size	Minute Hole	Item No.
2-1/2"	Oblong	H-109L
2-1/2"	Square	H-109S

Spade Style



Minute Hand Size	Minute Hole	Item No.
2-1/4"	Oblong	H-101L
2-1/4"	Square	H-101S
2-1/2"	Oblong	H-102L
2-1/2"	Square	H-102S
3-1/2"	Oblong	H-103L
3-1/2"	Square	H-103S
4-3/4"	Oblong	H-104L
4-3/4"	Square	H-104S

\$2.00 pr. 6+ **\$1.75** pr.

New Tall Case Hands

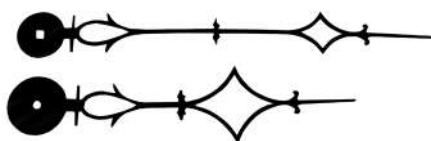

Item No. **H-370** **\$32.95** pr.

High Quality. Blued Steel.
Pilot holes drilled in both hour and minute hands. 5-5/8" min. hand

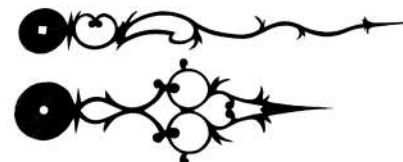

Item No. **H-371** **\$38.95** pr.

May mix & match hands to receive quantity discounts.

Mechanical Clock Hands

Black, Sold in Pairs (Minute hand measured from center of hole to tip of hand)

Hermle Hands

2.2mm square minute hand bushing and 4.5mm round hour hand bushing.



Minute Hand	Item No.
1-3/4"	H-301
2-3/8"	H-304
2-3/4"	H-305

\$6.00 pr.

Minute Hand	Item No.
3"	H-306
3-1/2"	H-307
4"	H-308
4-3/4"	H-309

\$6.50 pr.

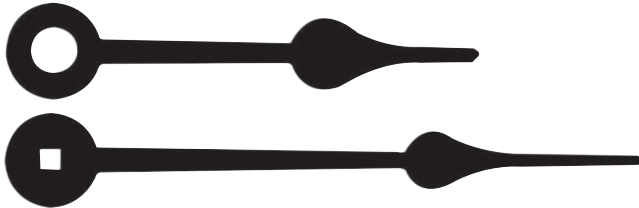

Used on ship bell movements. 2.2mm square minute hand bushing and 4.5mm round hour hand bushing.

Minute Hand	Item No.
2-1/2"	H-310

\$9.95 pr.

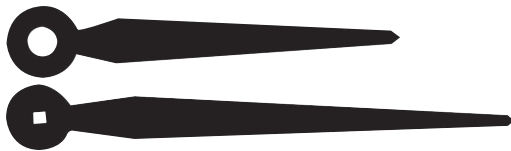

2.2mm square minute hand bushing and 4.5mm round hour hand bushing.

Minute Hand	Item No.
3-1/8"	H-302
3-1/2"	H-303

\$4.95 pr.

Hermle Second Hands

3/4" tip to center.
1-1/8" overall.
1-5/16" shaft.

Item No. **SH-34** **\$6.00** ea.



Kieninger Hands

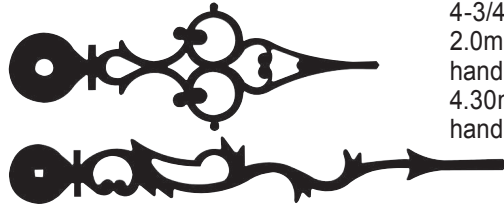

4-3/4" Minute Hand.
2.0mm square minute hand bushing and 4.30mm round hour hand bushing.

Item No. **H-311**

\$7.95 pr.

Kieninger Second Hands

7/8" tip to center. 1-5/8" overall. 1-1/8" shaft.

Item No. **SK-78L**
\$6.50 ea.



Generic Spade Hands

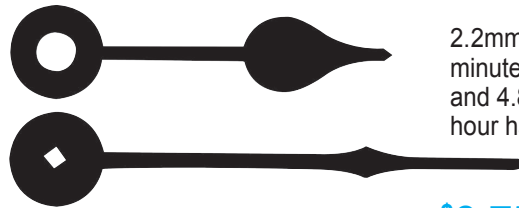

2.2mm square minute hand bushing and 4.8mm round hour hand bushing.

Minute Hand Item No.
2-5/8" **H-312**

\$3.75 pr.
6+ **\$3.50** pr.

Great Closeouts!

All at Great Prices! 1-of-a-kinds, stock reductions, buy outs, estate items & much more!

Visit our ebay Store

stores.ebay.com/Ronell-Clock-Company

or Our Website

ronellclock.com

Ordering can be **Fast** and **Easy**... just visit our website

www.ronellclock.com

For Orders Only
Call Toll Free **1-800-334-0135**

Or send orders to our e-mail address

info@ronellclock.com

Quartz Fit-Up Movements

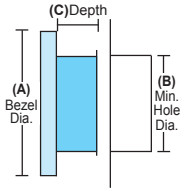

Mini Quartz Fit-Up Movements

1 Year Guarantee and Replaceable Watch Battery included. Images Not to Scale.

NEW
MF-98WA



MF-100WA
MF-100SWA

NEW



MF-100WR



MF-101FA
MF-20FA



MF-102FR



MF-24VA



MF-104WA



MF-105WA MF-106GA
MS110SWA



MF-107WR MF-108GR
MF-110SWR

High Quality Seiko Movement
with Waterfall Bezel



MF-109WA



MF-24VR

Item No.	Bezel Dia. (A)	Minimum Hole Dia. (B)	Depth (C)	Bezel Color	Dial Color	Numeral	Battery	1	3	6	12+
MF-98WA	29/32"	7/8"	1/4"	Gold	White	Arabic	Watch	\$6.95	\$6.50	\$6.25	\$5.95
MF-100SWA	1-7/16"	1-3/8"	5/16"	Silver	White	Arabic	Watch	\$5.95	\$5.50	\$5.25	\$4.95
MF-100WA	1-7/16"	1-3/8"	5/16"	Gold	White	Arabic	Watch				
MF-100WR	1-7/16"	1-3/8"	5/16"	Gold	White	Roman	Watch	\$6.95	\$6.50	\$6.25	\$5.95
MF-101FA	1-7/16"	1-3/8"	1/4"	Gold	Fancy	Arabic	Watch				
MF-102FR	1-7/16"	1-3/8"	1/4"	Gold	Fancy	Roman	Watch				
MF-104WA	1-7/16"	1-3/8"	1/4"	Gold	White	Arabic	Watch				
MF-105WA	1-7/16"	1-3/8"	1/4"	Gold	White	Arabic	Watch				
MF-106GA	1-7/16"	1-3/8"	1/4"	Gold	Gold	Arabic	Watch				
MF-107WR	1-7/16"	1-3/8"	1/4"	Gold	White	Roman	Watch				
MF-108GR	1-7/16"	1-3/8"	1/4"	Gold	Gold	Roman	Watch				
MF-110SWA	1-7/16"	1-3/8"	1/4"	Silver	White	Arabic	Watch				
MF-110SWR	1-7/16"	1-3/8"	1/4"	Silver	White	Roman	Watch				
MF-109WA	1-3/4"	1-1/2"	1/4"	Gold	White	Arabic	Watch	\$12.95	\$12.50	\$11.95	\$11.50
MF-20FA	2"	1-7/8"	7/16"	Gold	Fancy	Arabic	Watch	\$9.95	\$9.50	\$9.25	\$8.95
MF-24VA	2"	1-7/8"	7/16"	Gold	Ivory	Arabic	Watch				
MF-24VR	2"	1-7/8"	7/16"	Gold	Ivory	Roman	Watch				

May mix styles & sizes to receive quantity discounts.

Images Not
to Scale

Quartz Fit-up Movements

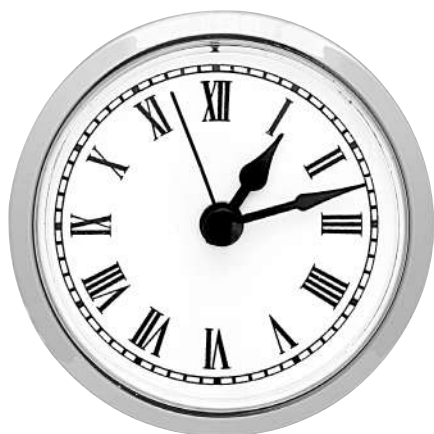

MF-201GR MF-201WR
MF-201VR MF-206WR



MF-202GA MF-202VA
MF-202WA



MF-203FA



MF-204GA MF-204WA

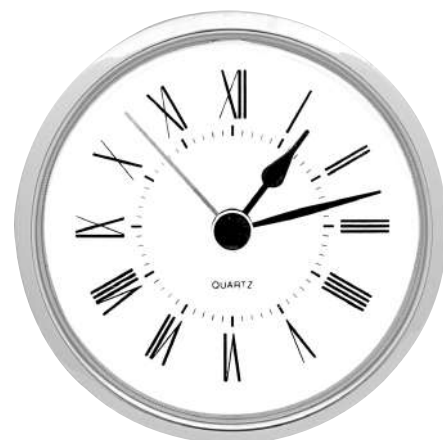

MF-205GR MF-205WR



MF-206WA MF-206-SWA

Item No.	Bezel Dia. (A)	Minimum Hole Dia. (B)	Depth (C)	Bezel Color	Dial Color	Numeral	Battery	1	3	6	12+
MF-201GR	2-1/4"	2-1/8"	5/8"	Gold	Gold	Roman	N	\$7.95	\$7.50	\$7.25	\$6.95
MF-201VR	2-1/4"	2-1/8"	5/8"	Gold	Ivory	Roman	N				
MF-201WR	2-1/4"	2-1/8"	5/8"	Gold	White	Roman	N				
MF-202GA	2-1/4"	2-1/8"	5/8"	Gold	Gold	Arabic	N				
MF-202WA	2-1/4"	2-1/8"	5/8"	Gold	White	Arabic	N				
MF-202VA	2-1/4"	2-1/8"	5/8"	Gold	Ivory	Arabic	N				
MF-203FA	2-1/4"	2-1/8"	5/8"	Gold	Fancy	Arabic	N				
MF-204GA	2-7/16"	2-1/4"	5/8"	Gold	Gold	Arabic	N	\$8.95	\$8.50	\$8.25	\$7.95
MF-204WA	2-7/16"	2-1/4"	5/8"	Gold	White	Arabic	N				
MF-205WR	2-7/16"	2-1/4"	5/8"	Gold	White	Roman	N				
MF-205GR	2-7/16"	2-1/4"	5/8"	Gold	Gold	Roman	N	\$11.95	\$11.50	\$10.95	\$10.50
MF-206WA	2-1/2"	2-1/4"	3/4"	Gold	White	Arabic	N				
MF-206SWA	2-1/2"	2-1/4"	3/4"	Silver	White	Arabic	N				
MF-206WR	2-9/16"	2-3/8"	3/4"	Gold	White	Roman	AAA				

Quartz Fit-up Movements

Images Not to Scale

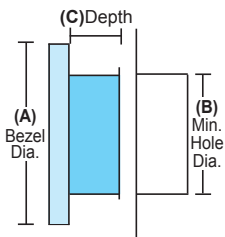

MF-207GA
MF-207WA
MF207VA
MF-215SWA
MF-216VA
MF-216WA

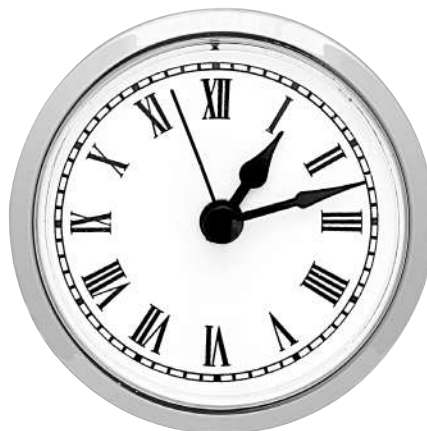

MF-209VR
MF-210GR
MF-210WR
MF-215SWR
MF-217WR



MF-213FA



MF-219FA



MF-220WA

Item No.	Bezel Dia. (A)	Minimum Hole Dia. (B)	Depth (C)	Bezel Color	Dial Color	Numeral	Battery	1	3	6	12+
MF-207GA	2-3/4"	2-3/8"	11/16"	Gold	Gold	Arabic	AAA	\$7.95	\$7.50	\$7.25	\$6.95
MF-207WA	2-3/4"	2-3/8"	11/16"	Gold	White	Arabic	AAA				
MF-207VA	2-3/4"	2-3/8"	11/16"	Gold	Ivory	Arabic	AAA				
MF-209VR	2-3/4"	2-3/8"	11/16"	Gold	Ivory	Roman	AAA				
MF-210GR	2-3/4"	2-3/8"	11/16"	Gold	Gold	Roman	AAA				
MF-210WR	2-3/4"	2-3/4"	11/16"	Gold	White	Roman	AAA				
MF-213FA	2-3/4"	2-3/8"	11/16"	Gold	Fancy	Arabic	AAA				
MF-216VA	2-13/16"	2-3/8"	1/2"	Gold	Ivory	Arabic	N				
MF-216WA	2-13/16"	2-3/8"	1/2"	Gold	White	Arabic	N				
MF-217WR	2-13/16"	2-3/8"	1/2"	Gold	White	Roman	N				
MF-219FA	2-13/16"	2-3/8"	1/2"	Gold	Fancy	Arabic	N	\$8.95	\$8.50	\$8.25	\$7.95
MF-220WA	2-15/16"	2-3/8"	2-1/4"	Gold	White	Arabic	Watch	\$7.95	\$7.50	\$7.25	\$6.95
MF-215SWA	2-7/8"	2-3/8"	11/16"	Silver	White	Arabic	AAA	\$7.95	\$7.50	\$7.25	\$6.95
MF-215SWR	2-7/8"	2-3/8"	11/16"	Silver	White	Roman	AAA	\$7.95	\$7.50	\$7.25	\$6.95

May mix styles & sizes to receive quantity discounts.

Quartz Fit-up Movements

Images Not to Scale

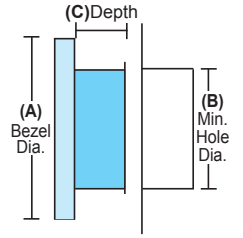

MF-300GA MF-300WA

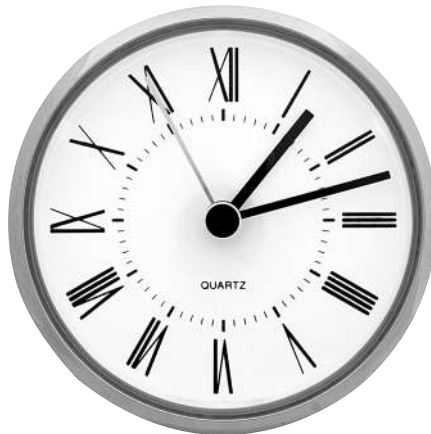

MF-301WR



- NEW MF-302VA
- NEW MF-302WA
- NEW MF-303SWA
- MF-303WA
- MF-304GA
- NEW MF-304SVA
- MF-304VA
- MF-304WA



MF-305GR MF-305WR



MF-306FA

Item No.	Bezel Dia. (A)	Minimum Hole Dia. (B)	Depth (C)	Bezel Color	Dial Color	Numeral	Battery	1	3	6	12+
MF-300GA	3-1/8"	3"	5/8"	Gold	Gold	Arabic	AA	\$7.95	\$7.50	\$7.25	\$6.95
MF-300WA	3-1/8"	3"	5/8"	Gold	White	Arabic	AA				
MF-301WR	3-1/8"	3"	5/8"	Gold	White	Roman	AA				
MF-302WA	3-3/16"	3"	3/4"	Gold	White	Arabic	AA	\$9.95	\$9.50	\$9.25	\$8.95
MF-302VA	3-3/16"	3"	3/4"	Gold	IVORY	Arabic	AA				
MF-303WA	3-5/16"	2-1/4"	3/4"	Gold	White	Arabic	N	\$12.95	\$12.50	\$11.95	\$11.50
MF-303SWA	3-5/16"	2-1/4"	3/4"	Silver	White	Arabic	N				
MF-304SVA	3-1/2"	3"	11/16"	Silver	White	Arabic	AA	\$11.95	\$11.50	\$11.25	\$10.95
MF-304GA	3-1/2"	3"	11/16"	Gold	Gold	Arabic	AA				
MF-304VA	3-1/2"	3"	11/16"	Gold	Ivory	Arabic	AA				
MF-304WA	3-1/2"	3"	11/16"	Gold	White	Arabic	AA				
MF-305GR	3-1/2"	3"	11/16"	Gold	Gold	Roman	AA				
MF-305WR	3-1/2"	3"	11/16"	Gold	White	Roman	AA				
MF-306FA	3-1/2"	3"	11/16"	Gold	Fancy	Arabic	AA				
								\$8.95	\$8.50	\$8.25	\$7.95

Quartz Fit-up Movements

MF-310VA
MF-400VA
MF-400WA
MF-405VA
MF-405WR
MF-405WA

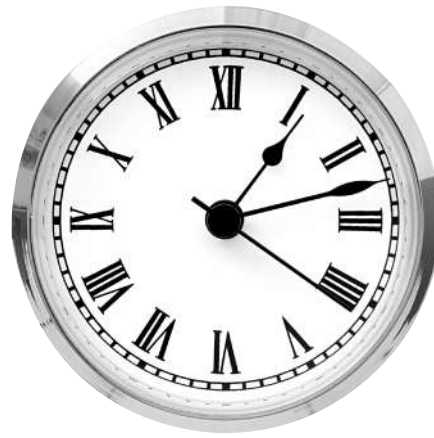

MF-310WR
MF-401VR
MF-401WR
MF-405VR
MF-405WR



New



MF-310FA MF-403FA

MF-380WA

MF-406WA

Item No.	Bezel Dia. (A)	Minimum Hole Dia. (B)	Depth (C)	Bezel Color	Dial Color	Numeral	Battery	1	3	6	12+
MF-310VA	3-7/8"	3-1/8"	5/8"	Gold	Ivory	Arabic	AA				
MF-310WR	3-7/8"	3-1/8"	5/8"	Gold	White	Roman	AA	\$11.95	\$11.50	\$11.25	\$10.95
MF-310FA	3-7/8"	3-1/8"	5/8"	Gold	Fancy	Arabic	AA				
MF-380WA	3-15/16"	3-1/4"	15/16"	Gold	White	Arabic	AA	\$18.95	\$18.50	\$18.25	\$17.95
MF-400VA	4"	2-1/4"	13/16"	Gold	Ivory	Arabic	AA				
MF-401VR	4"	2-1/4"	13/16"	Gold	Ivory	Roman	AA	\$10.50	\$9.95	\$9.75	\$9.50
MF-400WA	4"	2-1/4"	13/16"	Gold	White	Arabic	AA				
MF-401WR	4"	2-1/4"	13/16"	Gold	White	Roman	AA				
MF-403FA	4-1/4"	3-1/8"	9/16"	Gold	Fancy	Arabic	AA				
MF-405VA	4-1/4"	3-1/8"	9/16"	Gold	Ivory	Arabic	AA				
MF-405VR	4-1/4"	3-1/8"	9/16"	Gold	Ivory	Roman	AA	\$15.50	\$14.95	\$14.75	\$14.50
MF-405WA	4-1/4"	3-1/8"	9/16"	Gold	White	Arabic	AA				
MF-405WR	4-1/4"	3-1/8"	9/16"	Gold	White	Roman	AA				
MF-406WA	4-1/2"	3-1/4"	15/16"	Gold	White	Arabic	AA	\$18.95	\$18.50	\$18.25	\$17.95

May mix styles & sizes to receive quantity discounts.

Quartz Fit-up Movements

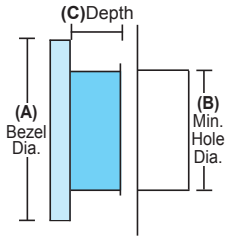

May mix styles & sizes to receive quantity discounts.



MF-502FR



MF-503GA WF-503WA



MF-505FA MF601FA
MF-606FA MF-708FA

New



MF-601VA MF-602WA



MF-601VR MF-602WR



MF-504WR MF-606GR

Item No.	Bezel Dia. (A)	Minimum Hole Dia. (B)	Depth (C)	Bezel Color	Dial Color	Numeral	Battery	1	3	6	12+
MF-502FR	5-1/8"	3-1/4"	15/16"	Gold	Fancy	Roman	AA	\$19.95	\$19.50	\$19.25	\$18.95
MF-503GA	5-7/8"	3-1/4"	15/16"	Gold	Gold	Arabic	AA				
MF-503WA	5-7/8"	3-1/4"	15/16"	Gold	White	Arabic	AA				
MF-504WR	5-7/8"	3-1/4"	15/16"	Gold	White	Roman	AA				
MF-505FA	5-7/8"	3-1/4"	15/16"	Gold	Fancy	Arabic	AA	\$18.95	\$18.50	\$18.25	\$17.95
MF-601FA	6"	3-1/8"	9/16"	Gold	Fancy	Arabic	AA				
MF-601VA	6"	3-1/8"	9/16"	Gold	Ivory	Arabic	AA				
MF-601VR	6"	3-1/8"	9/16"	Gold	Ivory	Roman	AA				
MF-602WA	6"	3-1/8"	9/16"	Gold	White	Arabic	AA	\$24.95	\$24.50	\$24.25	\$23.95
MF-602WR	6"	3-1/8"	9/16"	Gold	White	Roman	AA				
MF-606FA	6-1/4"	3-1/4"	15/16"	Gold	Fancy	Arabic	AA				
MF-606GR	6-1/4"	3-1/4"	15/16"	Gold	Gold	Roman	AA				
MF-708FA	7-7/8"	3-1/4"	15/16"	Gold	Fancy	Arabic	AA	\$28.95	\$28.50	\$27.50	26.95

Soft Rubber Mounting Gasket

Creates a friction fit without screws or glue.



Item No.	Diameter	Fits Backs	1	6	12	24+
MRG-1	1"	1" to 1-7/16"	45¢	40¢	30¢	25¢
MRG-2	2"	2" to 3-1/2"				
MRG-3	3"	3" to 4"				

Clock Numerals

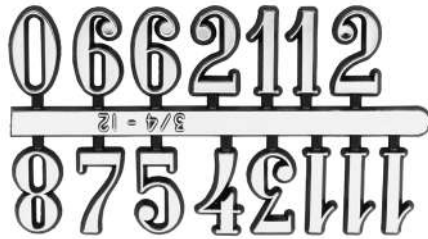

Arabic

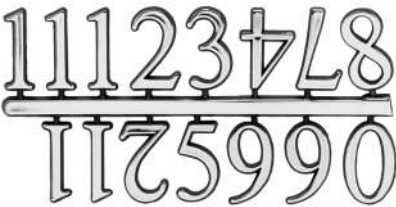

Classic

Plastic, Gold on Black
Numbers 1-12

Quantity Prices Per Sprue

1	12	30	50+
\$1.25	\$1.00	95¢	80¢

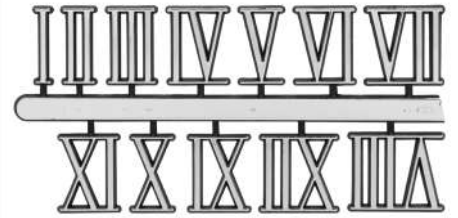

Roman

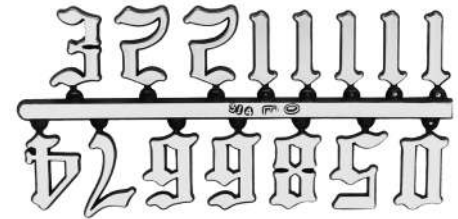

Old English

May mix styles & sizes to receive quantity discounts.

1-12 One Clock Face Per Sprue				
Size	Arabic	Classic	Old English	Roman
3/8"	NA112-38	NC112-38	NO112-38	NR112-38
1/2"	NA112-12	NC112-12	-----	NR112-12
5/8"	NA112-58	NC112-58	NO112-58	NR112-58
3/4"	NA112-34	NC112-34	NO112-34	NR112-34
13/16"	NA112-1316	-----	-----	NR112-1316
1"	NA112-01	NC112-01	NO112-01	NR112-01
1-1/4"	NA112-114	-----	-----	NR112-114

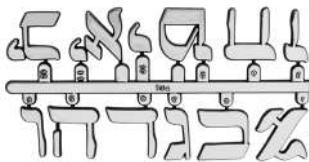

Hebrew

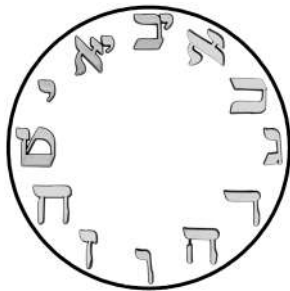

Quantity Prices Per Sprue

1	12	30	50+
\$1.25	\$1.00	95¢	80¢

Size	Hebrew	Chinese
1/2"	NH112-12	NCH112-12
3/4"	NH112-34	NCH112-34

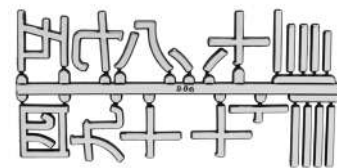

Chinese

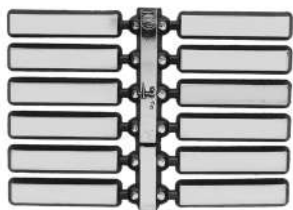
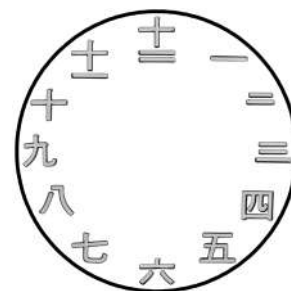

12 Dashes

Dashes and Dots

Plastic, Gold on Black

Size	Dashes	Size	Dots
7/16"	NDA-716	3/16"	NDO-316
5/8"	NDA-58	1/4"	NDO-14
3/4"	NDA-34	3/8"	NDO-38
1"	NDA-01	1/2"	NDO-12
		5/8"	NDO-58

1	12	30+
80¢	75¢	70¢

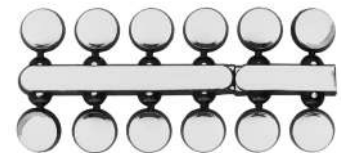

12 Dots



Alphabet

Be creative! Put a favorite saying or your name on a clock dial, or anything you can imagine. 59 letters. Plastic material. Gold on Black letters.

Prices Per Sprue

Size	Item No.	1	12+
1/2"	NAL-12	\$3.00	\$2.75
3/4"	NAL-34		
1"	NAL-01		

9 Pc. Dial Template

Easily do any shape dial or size. Set includes: oval, triangle, square, 60° ellipse, 45° ellipse, circle, hexagon, rectangle, octagon, and instructions.

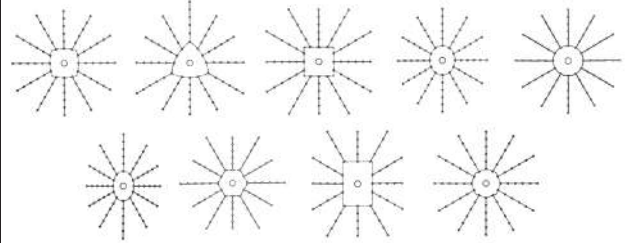

Item No. **DT-09** **\$4.00** set

Decorative Dial Corners

4 pcs. to a set

Size	Heart	Scroll	Grandfather	Embossed Wood	1	3	6+
1"	DCH-01	DCS-01	-----	-----	\$2.00	\$1.75	\$1.50
2"	DCH-02	DCS-02	-----	-----	\$2.50	\$2.25	\$2.00
3"	DCH-03	DCS-03	-----	-----	\$3.00	\$2.75	\$2.50
2-3/8"	-----	-----	DCG-02	-----	\$4.95		
3-3/8"	-----	-----	DCG-03	-----	\$5.95		
3-3/8"	-----	-----	-----	DCW-03	\$2.95		



4 pc. Set Mantle Clock Paper Dials

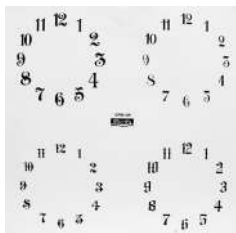

No minute marks or chapter rings. Numbers are spaced to align with openings in fancy embossed dial plates used on some black mantles & china clocks. Copied from 4 brands of American clocks. Sizes: 2 at 3-3/4" & 2 at 4-1/8". On a 11"x11" card.

Ivory Item No. **DPM-4V** 1 3 6+
White Item No. **DPM-4W** **\$2.00** **\$1.75** **\$1.50**

Seth Thomas Black Mantle



For Adamantine & other mantles. Seth Thomas trademark. Arabic numerals & diamond markers on time track. White or ivory paper.

Size	White	Ivory
4-1/4"	DPM-4250	DPM-4251
4-1/2"	DPM-4500	DPM-4501

\$1.00 ea. **\$10.00** doz.

New Rotary Paper Dial Cutter

7/8" dia. high speed steel blade. Cuts circles from 1-1/8" to 13". 8" long.

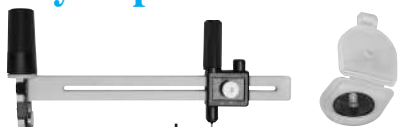

Extra Blade **\$3.00** ea.

Item No. **TL-146A**

Item No. **TL-146** **\$12.95**



Coca Cola Paper Dials

On ivory paper with red advertising, black numerals and time track.

Size	Arabic	Roman	1	12+
7"	DPC-7001A	DPC-7001R	\$2.00	\$1.50
11"	DPC-1101A	DPC-1101R	\$3.00	\$2.50

42 *May mix styles & sizes for each product to receive quantity discounts.*

Dials

Trademark Paper Dials

Antique Ivory

Size	Trademark	Arabic No.	Roman No.
4-1/2"	Ansonia	DPTA-4501A	DPTA-4501R
	Gilbert	DPTG-4501A	DPTG-4501R
	Ingraham	DPTI-4501A	DPTI-4501R
	New Haven	DPTN-4501A	DPTN-4501R
	Sessions	DPTS-4501A	DPTS-4501R
	Seth Thomas	DPTT-4501A	DPTT-4501R
	Waterbury	DPTW-4501A	DPTW-4501R
	EN Welch	DPTE-4501A	DPTE-4501R
5"	Ansonia	DPTA-5001A	DPTA-5001R
	Gilbert	DPTG-5001A	DPTG-5001R
	Ingraham	DPTI-5001A	DPTI-5001R
	New Haven	DPTN-5001A	DPTN-5001R
	Sessions	DPTS-5001A	DPTS-5001R
	Seth Thomas	DPTT-5001A	DPTT-5001R
	Waterbury	DPTW-5001A	DPTW-5001R
	EN Welch	DPTE-5001A	DPTE-5001R
7"	Ansonia	-----	DPTA-7001R
	Gilbert	-----	DPTG-7001R
	Ingraham	-----	DPTI-7001R
	New Haven	-----	DPTN-7001R
	Sessions	-----	DPTS-7001R
	Seth Thomas	-----	DPTT-7001R
	Waterbury	-----	DPTW-7001R
	EN Welch	-----	DPTE-7001R
9"	Ansonia	-----	DPTA-9001R
	Gilbert	-----	DPTG-9001R
	Ingraham	-----	DPTI-9001R
	New Haven	-----	DPTN-9001R
	Sessions	-----	DPTS-9001R
	Seth Thomas	-----	DPTT-9001R
	Waterbury	-----	DPTW-9001R
	EN Welch	-----	DPTE-9001R
11"	Ansonia	DPTA-1101A	DPTA-1101R
	Gilbert	DPTG-1101A	DPTG-1101R
	Ingraham	DPTI-1101A	DPTI-1101R
	New Haven	DPTN-1101A	DPTN-1101R
	Sessions	DPTS-1101A	DPTS-1101R
	Seth Thomas	DPTT-1101A	DPTT-1101R
	Waterbury	DPTW-1101A	DPTW-1101R
	EN Welch	DPTE-1101A	DPTE-1101R

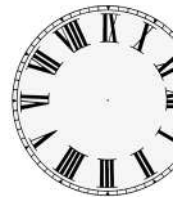

Reproduction Paper Dials

Antique Ivory

Size	Arabic No.	Roman No.
2"	DPR-2001A	DPR-2001R
2-1/4"	DPR-2251A	DPR-2251R
2-1/2"	DPR-2501A	DPR-2501R
2-3/4"	DPR-2751A	DPR-2751R
3"	DPR-3001A	DPR-3001R
3-1/4"	DPR-3251A	DPR-3251R
3-1/2"	DPR-3501A	DPR-3501R
3-3/4"	DPR-3751A	DPR-3751R
4"	DPR-4001A	DPR-4001R
4-1/4"	DPR-4251A	DPR-4251R
4-1/2"	DPR-4501A	DPR-4501R
4-3/4"	DPR-4751A	DPR-4751R
5"	DPR-5001A	DPR-5001R
5-1/4"	DPR-5251A	DPR-5251R
5-1/2"	DPR-5501A	DPR-5501R
5-3/4"	DPR-5751A	DPR-5751R
6"	DPR-6001A	DPR-6001R
6-1/4"	DPR-6251A	DPR-6251R
6-1/2"	DPR-6501A	DPR-6501R
6-3/4"	DPR-6751A	DPR-6751R
7"	DPR-7001A	DPR-7001R
7-1/2"	DPR-7501A	DPR-7501R
8"	DPR-8001A	DPR-8001R
9"	DPR-9001A	DPR-9001R
10"	DPR-1001A	DPR-1001R
11"	DPR-1101A	DPR-1101R
12"	DPR-1201A	DPR-1201R

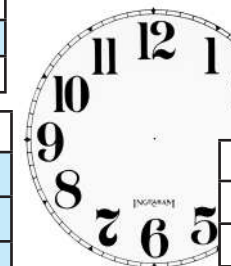
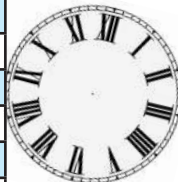
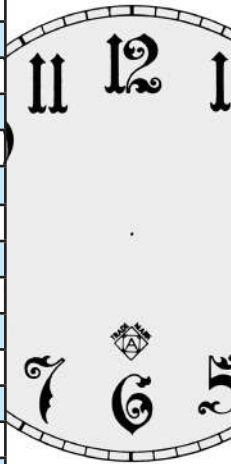
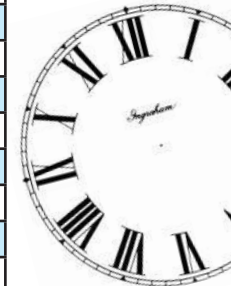

Sizes	Each	Per Dozen	100 Pc.
4-1/2" - 5"	75¢	\$6.50	\$32.00
7"	75¢	\$6.50	\$32.00
9" - 11"	\$1.00	\$9.00	\$32.00

Sizes	Each	Per Dozen	100 Pc.
2" - 7-1/2"	75¢	\$6.50	\$32.00
8" - 12"	\$1.00	\$9.00	\$32.00

May mix styles & sizes to receive quantity discounts.

Dials



See Inside Back Cover for Full Color Photos



Fancy Filigree Dials

White time ring, black nos., goldtone filigree center.

Size	Arabic	Roman	1	6	12+
4-1/2"	DM-30-4	DM-31-4	\$4.00	\$3.75	\$3.50
6"	DM-30-6	DM-31-6	\$4.50	\$4.25	\$4.00
7-7/8"	DM-30-7	DM-31-7	\$6.00	\$5.75	\$5.50

Vienna Regulator Dials

Embossed, white with black nos. Gold raised edge & gold inner ring. Metal.

Size	Arabic	Roman	1	6	12+
6-1/2"	DM-32-6	DM-33-6	\$6.95	\$6.50	\$6.25
8"	DM-32-8	DM-33-8	\$7.95	\$7.50	\$7.25



Dials with Bezel & Glass

Press fit mounting. Solid brass diamond cut bezel with convex glass. Aluminum dial with off white time ring, black numerals & filigree designs; a fancy copper & gold floral leaf center. Mounts with a steel backplate. Bezel and glass are easily removed for hand mounting or adjustment.

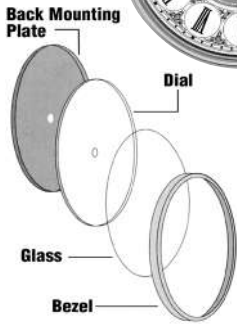

Style	Arabic	Roman	1	6+
4"	DB20-4	DB21-4	\$18.00	\$16.00
5-1/8"	DB20-5	DB21-5	\$20.00	\$18.00
6-1/4"	DB20-6	DB21-6	\$23.00	\$21.00
7-7/8"	DB20-7	DB21-7	\$26.00	\$24.00



Gold & Ivory Dials

Black numerals. Metal.



Size	Style	Gold	Ivory	1	6	12+
4-1/2"	Arabic	DM-G40	DM-V40	\$4.00	\$3.75	\$3.50
6"	Arabic	DM-G60	DM-V60	\$4.50	\$4.25	\$4.00
6"	Roman	DM-G61	-----	\$4.50	\$4.25	\$4.00
6-3/4"	Arabic	DM-G640	-----	\$5.00	\$4.75	\$4.50
7-7/8"	Arabic	DM-G780	DM-V780	\$6.00	\$5.75	\$5.50

New Styrene Dials Arabic



	Part #	O.D.	Time Ring	1	6	12+
W H I T E	D10-4	4-1/8"	3-3/4"	\$3.00	\$2.75	\$2.50
	D10-5	5-1/2"	5"			
	D10-8	8-1/4"	7-1/2"			
	D10-9	9-13/16"	8-7/8"			
I V O R Y	D11-4	4-1/2"	4-1/8"	\$3.25	\$3.00	\$2.75
	D11-5	5-7/8"	5-5/16"			
	D11-7	7-1/2"	6-3/4"			
	D11-9	9-13/16"	8-7/8"			

Embossed Dial Pan Bezel Assemblies

New

Exact reproduction of an American style embossed dial pan & bezel assembly. Front bezel: 5-3/4" dia. Back assembly: 5-5/8" dia. White dial: 4-1/2" dia. Embossed center: 2-3/16" dia. Center hole: 3/8" dia. Back side assembly requires a recess of 5-3/8" in the case. Bezel can be removed and riveted to an old pan. **Requires 5-3/8" flat glass**, not included.



Antique Item No. DB-10

Polished Brass Item No. DB-11

\$19.95 ea.

Ordering can be **Fast** and **Easy**... just visit our website

ronellclock.com

Metal Dials

New



DM-09

New

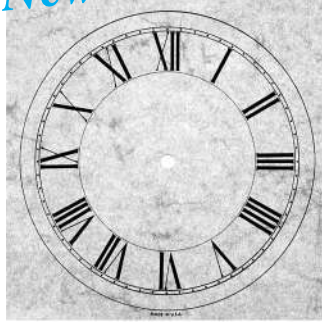

DM-10

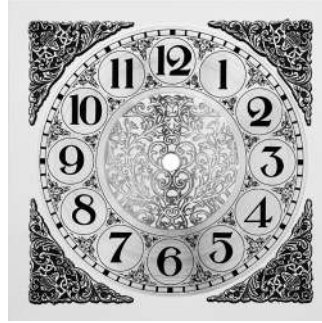

DM-11



DM-12



DM-13



DM-14



DM-15



DM-16



DM-17



DM-18

See Inside Back Cover
for Full Color Photos

New

New

Item No.	Size	Time Ring	Description	1	3	6+
DM-09	7-1/2" sq.	6-1/8"	Embossed Gold Embossed gold background. Ivory time ring, gold Roman numerals and black filigree.	\$6.95	\$6.50	\$6.00
DM-10	9" sq.	7-1/2"	Parchment look finish. Black lines and Roman numerals.	\$12.99		
DM-11	7-1/2" sq.	6-1/16"	Raised Corners. gold w/gold time ring. Black designs and Arabic numerals.	\$11.99		
DM-12			As above. Roman numerals.			
DM-13	7-1/4" sq.	6-1/4"	Fancy Frosted off-white design on gold background. Black Arabic numerals and design.	\$6.95	\$6.75	\$6.50
DM-14	7-7/8" sq.	7"	Fancy gold and black designs. White time ring. Arabic numerals.	\$7.50	\$7.25	\$6.95
DM-15			As above. Roman numerals.			
DM-16	9-7/8" sq.	7-1/2"	Floral gold and dark brown designs. Silver time ring with black Roman numerals.	\$10.95	\$10.50	\$10.25
DM-17	7-7/8"W x 10-1/4"H	6-3/4"	Tempus Fugit. brushed gold with fancy black designs, center & numbers. White time ring and Fugit symbol. Roman numerals.	\$8.50	\$8.25	\$8.00
DM-18	9-7/8"W x 13"H	8"	Tempus Fugit Grandmother size. Gold with silver time ring and Fugit symbol. Applied corners and arch filigrees. Applied Arabic numerals.	\$34.95	\$32.95	\$32.00

May mix styles & sizes to receive quantity discounts.

New Rub-On Dial Transfers

Transfers are designed to be applied to existing glass or dials by a pressure transfer method. Instructions included.

Trademark Assortments

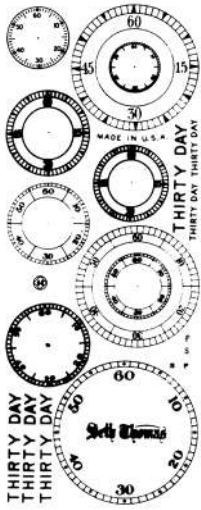

B-1 (Black)
1-1/8" to 2-9/16" Dia.



B-2 (Black)
Trademarks 4"-8" dials



B-3 (Black)
Trademarks 9"-12" dials



B-4 (Black)
Manufacturers Names



B-51 (Black)
Trademarks 9"-12" dials



B-53 (Black)
Trademarks 4"-8" dials

Miscellaneous Assortments



2"W x 1"H
B-20B (Black)

2-1/2"W x 1-1/4"H
B-20G (Gold)

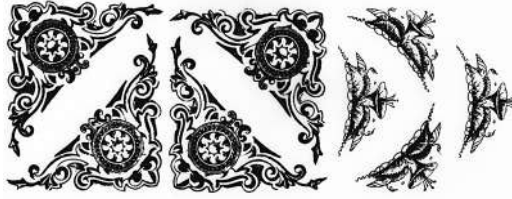

2-1/2"W x 1-5/8"H
B-21B (Black) B-21BL (Blue) B-21G (Green)

\$6.00 ea.
2 for
\$10.00

Numerals

See Our Website for More Transfer Designs! ronellclock.com

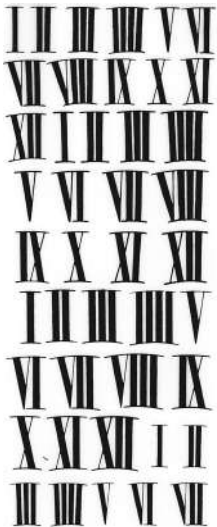

B-9A 1/2" No.'s **B-9B** 3/4" No.'s
B-9C 1-1/2" No.'s



B-6D (Black)
ST Mfg. Names



B-7A (Black)
Fancy Arabic 4"-6" dials



B-7B (Black)
Fancy Arabic 3"-7" dials

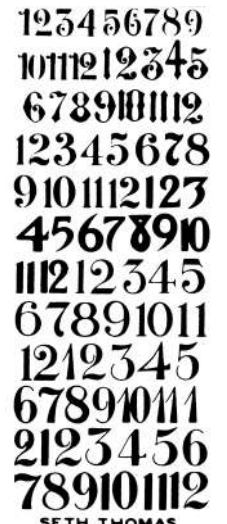

B-7C (Black)
Fancy Arabic 4"-7" dials

New Rub-On Dial and Door Transfers

Transfers are designed to be applied to existing glass or dials by a pressure transfer method.
Instructions included.

See Our Website for More Transfer Bargains!

\$6.00 ea.
2 for \$10.00



4" Long



5" Long



4-1/4" Long

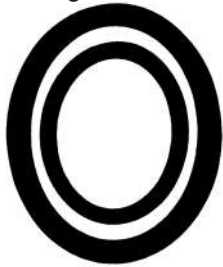

B-36 (Gold)



B-38G (Gold)
B-38B (Black)



B-39 (Gold)

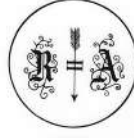
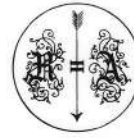

2" Dia.

B-34B (Black)
B-34G (Gold)



B-63 (Gold)
3-1/2"W x 6"H



2"H x 4-1/2"L

B-70 (Gold)



1-3/4"H x 3-1/4"L

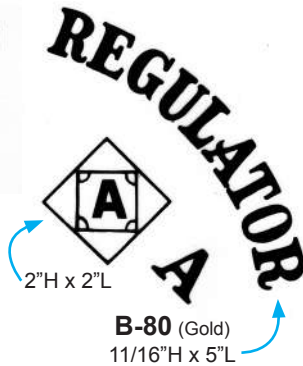

2"H x 2"L

B-80 (Gold)
11/16"H x 5"L



B-129 (Gold) 7/8"H x 5-5/8"L Regulator

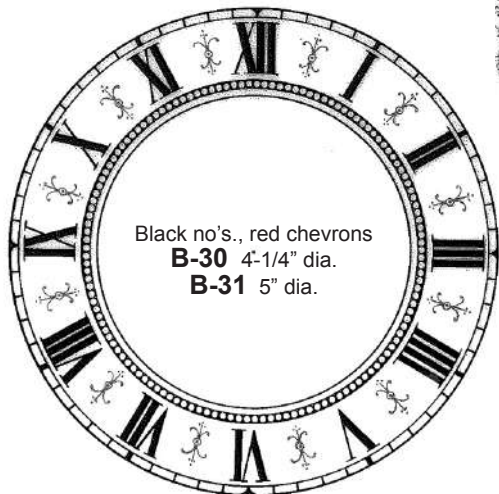

Black no's., red chevrons
B-30 4-1/4" dia.
B-31 5" dia.



B-155 (Black) 4-5/8"W x 4-1/8"H

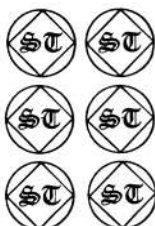

B-162 (Black) 3/8" Letters 7/8" Trademarks

Seth Thomas
Seth Thomas
SETH THOMAS
SETH THOMAS



B-13 (Black)
1/4" Months
3/4" Dates

Calendars

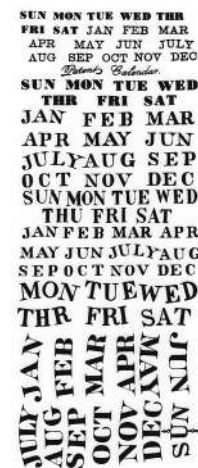

B-14 (Black)
1/8", 1/4", 5/16"
Months

E. HOWARD & CO.
BOSTON.
E. HOWARD & CO.
BOSTON.
E. HOWARD & CO.
BOSTON.
E. HOWARD & CO.
BOSTON.
E. HOWARD & CO.
BOSTON.
E. HOWARD & CO.
BOSTON.
E. HOWARD & CO.
BOSTON.
E. HOWARD & CO.
BOSTON.
E. HOWARD & CO.
BOSTON.

B-22 (Black)
1/4" & 3/8"
Letters



B-116G
(Gold)

B-116S
(Silver)

4-3/4"W x
6-5/8"H

May mix styles to receive quantity discounts.

New Rub-On Door Transfers

Transfers are designed to be applied to existing glass or dials by a pressure transfer method. Instructions included.

See Our Website for More Transfer Designs! ronellock.com

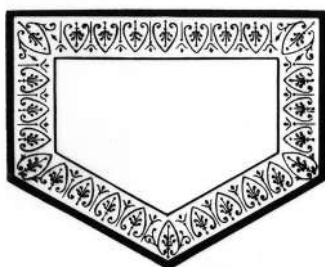

B-114 (Gold)
5-1/8" x 4-1/4"

Size	Item No.
2-1/2" x 3"	B-54
5" x 5"	B-55
5-11/16" x 6"	B-56

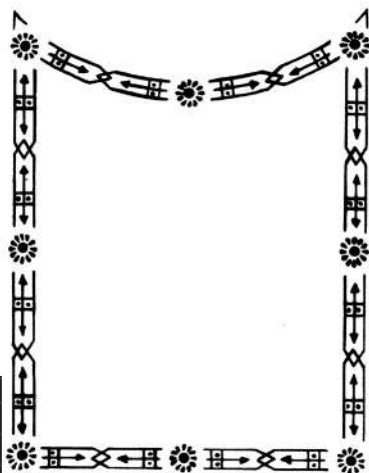

B-54, B-55, B-56 (Gold)



B-57 (Gold)
Welch Design 5" x 6"



B-86 (Gold)
Geometric Design 5-1/2" x 7"

Kitchen Clock Designs

All designs are available in gold only.

\$6.00 ea.
2 for **\$10.00**



B-73 (Gold)
Music 6" x 9"



B-75 (Gold)
Vines 6" x 8-1/2"



B-79 (Gold)
Statue 6" x 9"

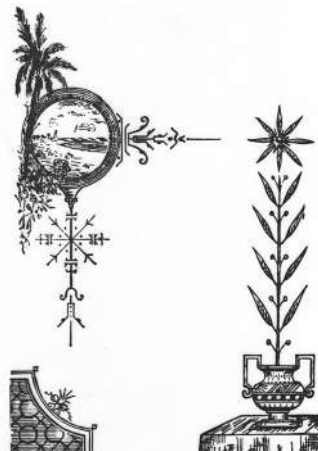

B-82 (Gold)
Ocean Scene 5" x 7-3/4"



B-83 (Gold)
Bird & Grape 5" x 7-1/2"



B-84 (Gold)
Ostrich Feather 5-1/2" x 8"



B-85 (Gold)
Stork 4-1/2" x 9"



B-87 (Gold)
Griffin 6" x 9"

Bezels, Pans & Accessories

Solid Brass Bezel & Convex Glass Assembly

New

American Style

Glass and hinge installed



Outside Dia.	Item No.	Price
5-1/2"	BEZ-13A	\$19.95
5-5/8"	BEZ-14A	
5-3/4"	BEZ-15A	
12-5/8"	BEZ-28A	\$49.95
13-1/8"	BEZ-29A	

Large German Bezel



NEW-Older Inventory

Polished brass finish with convex glass. Hinged with 2 threaded mounting posts. Pull tab and pin clasp. Fully assembled.

Outside Dia.	Item No.	Price
10-1/8"	BEZ-31	\$32.95
11-3/8"	BEZ-32	

Brass Bezels

American Style

With hinge & glass tabs. Measurement, from outside edge to outside edge. Glass not included.



Size	Item No.	Price	Size	Item No.	Price	
3-1/8"	BEZ-02	\$13.50	6"	BEZ-17	\$17.50	
3-1/2"	BEZ-03		6-1/8"	BEZ-18		
4"	BEZ-04	\$15.00	6-1/4"	BEZ-19		
4-3/8"	BEZ-05		6-3/8"	BEZ-20		
4-1/2"	BEZ-06		6-1/2"	BEZ-21		
4-3/4"	BEZ-07		7"	BEZ-22		
4-7/8"	BEZ-08	\$15.50	7-1/2"	BEZ-23		\$19.50
5"	BEZ-09		8-5/8"	BEZ-24		
5-1/8"	BEZ-10		8-7/8"	BEZ-25		
5-1/4"	BEZ-11		10-1/2"	BEZ-26	\$22.00	
5-3/8"	BEZ-12		10-7/8"	BEZ-27		
5-1/2"	BEZ-13		12-5/8"	BEZ-28	\$28.50	
5-5/8"	BEZ-14	13-1/8"	BEZ-29			
5-3/4"	BEZ-15	\$34.50	15"	BEZ-30		
5-7/8"	BEZ-16					

Seth Thomas Bezel

5-9/16" from outside edge to outside edge. With hinge & glass tabs. Glass not included.

Item No. **BEZ-50** **\$15.00**



Bezel Hinge Kits

Includes bezel hinge and glass tabs. For use in repairing your old bezels.

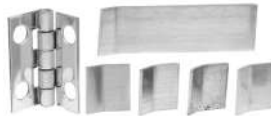

Hinge Size	Item No.	Price	Hinge Size	Item No.	Price
3/4"	BEZA-03	\$2.50	1-1/4"	BEZA-04	\$3.50

20pc. Glass Tab Assortment

Brass. 4 ea. of 5 styles. Soldering required.

Item No. **BEZA-01** **\$3.50**

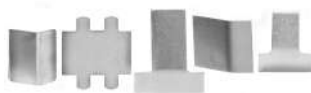

Bezel Latch

Brass. Screws in place. No soldering required.

Item No. **BEZA-02**

\$3.00 3 for **\$8.25**



Dial Pans

Brass plated steel pan. Drilled center hole. Measurement, from outside edge to outside edge.



Size	Item No.	Price	Size	Item No.	Price
4-3/4"	PAN-01	\$11.50	6-3/8"	PAN-08	\$14.50
5"	PAN-02		Scalloped Hole-Alarm	PAN-09	
5-1/4"	PAN-03		8-5/8"	PAN-10	\$17.50
5-1/2"	PAN-04		8-7/8"	PAN-11	
5-3/4"	PAN-05		10-1/2"	PAN-12	\$18.75
6"	PAN-06		10-7/8"	PAN-13	
6-3/8"	PAN-07	\$14.50	12-5/8"	PAN-14	\$19.50
Kitchen Clock			13-1/8"		

May mix styles & sizes for each product to receive quantity discounts.

Clock Glass

Round Flat:

GLF-650 . . . 2"
GLF-651 . . . 2-1/8"
GLF-652 . . . 2-1/4"
GLF-653 . . . 2-3/8"
GLF-654 . . . 2-7/16"
GLF-655 . . . 2-1/2"
GLF-656 . . . 2-5/8"
GLF-657 . . . 2-3/4"
GLF-658 . . . 2-7/8"
GLF-659 . . . 3"
GLF-660 . . . 3-1/8"
GLF-661 . . . 3-1/4"
GLF-662 . . . 3-3/8"
GLF-663 . . . 3-1/2"
GLF-664 . . . 3-5/8"
GLF-665 . . . 3-3/4"
GLF-666 . . . 3-7/8"
GLF-667 . . . 4"
GLF-668 . . . 4-1/8"
GLF-669 . . . 4-1/4"
GLF-670 . . . 4-3/8"
GLF-671 . . . 4-1/2"
GLF-672 . . . 4-5/8"
GLF-673 . . . 4-11/16"
GLF-674 . . . 4-3/4"
GLF-675 . . . 4-7/8"
GLF-676 . . . 5"
GLF-677 . . . 5-1/8"
GLF-678 . . . 5-1/4"
GLF-679 . . . 5-3/8"
GLF-680 . . . 5-1/2"
GLF-681 . . . 5-5/8"
GLF-682 . . . 5-3/4"
GLF-683 . . . 5-7/8"
GLF-684 . . . 6"
GLF-685 . . . 6-1/8"
GLF-686 . . . 6-1/4"
GLF-687 . . . 6-3/8"
GLF-688 . . . 6-1/2"
GLF-689 . . . 6-5/8"
GLF-690 . . . 6-3/4"
GLF-691 . . . 6-7/8"
GLF-692 . . . 7"
GLF-693 . . . 7-1/4"
GLF-694 . . . 7-3/8"
GLF-695 . . . 7-1/2"

GLF-696 . . . 7-5/8"
GLF-697 . . . 7-3/4"
GLF-698 . . . 7-7/8"
GLF-699 . . . 8-1/8"
GLF-700 . . . 8-1/4"
GLF-701 . . . 8-3/8"
GLF-702 . . . 8-1/2"
GLF-703 . . . 9"
GLF-704 . . . 9-3/4"
GLF-705 . . . 10"
GLF-706 . . . 10-1/8"
GLF-707 . . . 10-1/2"
GLF-708 . . . 11"
GLF-709 . . . 11-1/2"
GLF-710 . . . 11-7/8"
GLF-711 . . . 12"
GLF-712 . . . 12-3/8"
GLF-713 . . . 12-1/2"

Round Convex:

GLC-510 . . . 2"
GLC-511 . . . 2-1/16"
GLC-512 . . . 2-1/8"
GLC-513 . . . 2-3/16"
GLC-514 . . . 2-1/4"
GLC-515 . . . 2-5/16"
GLC-516 . . . 2-3/8"
GLC-517 . . . 2-7/16"
GLC-518 . . . 2-1/2"
GLC-519 . . . 2-9/16"
GLC-520 . . . 2-5/8"
GLC-521 . . . 2-11/16"
GLC-522 . . . 2-3/4"
GLC-523 . . . 2-13/16"
GLC-524 . . . 2-7/8"
GLC-525 . . . 2-15/16"
GLC-526 . . . 3"
GLC-527 . . . 3-1/16"
GLC-528 . . . 3-1/8"
GLC-529 . . . 3-3/16"
GLC-530 . . . 3-1/4"
GLC-531 . . . 3-5/16"
GLC-532 . . . 3-3/8"
GLC-533 . . . 3-7/16"
GLC-534 . . . 3-1/2"
GLC-535 . . . 3-9/16"
GLC-536 . . . 3-5/8"

GLC-537 . . . 3-11/16"
GLC-538 . . . 3-3/4"
GLC-539 . . . 3-13/16"
GLC-540 . . . 3-7/8"
GLC-541 . . . 3-15/16"
GLC-542 . . . 4"
GLC-543 . . . 4-1/16"
GLC-544 . . . 4-1/8"
GLC-545 . . . 4-3/16"
GLC-546 . . . 4-1/4"
GLC-547 . . . 4-5/16"
GLC-548 . . . 4-3/8"
GLC-549 . . . 4-7/16"
GLC-550 . . . 4-1/2"
GLC-551 . . . 4-9/16"
GLC-552 . . . 4-5/8"
GLC-553 . . . 4-11/16"
GLC-554 . . . 4-3/4"
GLC-555 . . . 4-13/16"
GLC-556 . . . 4-7/8"
GLC-557 . . . 4-15/16"
GLC-558 . . . 5"
GLC-559 . . . 5-1/16"
GLC-560 . . . 5-1/8"
GLC-561 . . . 5-3/16"
GLC-562 . . . 5-1/4"
GLC-563 . . . 5-5/16"
GLC-564 . . . 5-3/8"
GLC-565 . . . 5-7/16"
GLC-566 . . . 5-1/2"
GLC-567 . . . 5-9/16"
GLC-568 . . . 5-5/8"
GLC-569 . . . 5-11/16"
GLC-570 . . . 5-3/4"
GLC-571 . . . 5-13/16"
GLC-572 . . . 5-7/8"
GLC-573 . . . 5-15/16"
GLC-574 . . . 6"
GLC-575 . . . 6-1/16"
GLC-576 . . . 6-1/8"
GLC-577 . . . 6-3/16"
GLC-578 . . . 6-1/4"
GLC-579 . . . 6-5/16"
GLC-580 . . . 6-3/8"
GLC-581 . . . 6-7/16"
GLC-582 . . . 6-1/2"
GLC-583 . . . 6-5/8"

GLC-584 . . . 6-3/4"
GLC-585 . . . 6-7/8"
GLC-586 . . . 7"
GLC-587 . . . 7-1/8"
GLC-588 . . . 7-1/4"
GLC-589 . . . 7-3/8"
GLC-590 . . . 7-1/2"
GLC-591 . . . 7-5/8"
GLC-592 . . . 7-3/4"
GLC-593 . . . 7-7/8"
GLC-594 . . . 8"
GLC-595 . . . 8-1/8"
GLC-596 . . . 8-1/4"
GLC-597 . . . 8-3/8"
GLC-598 . . . 8-1/2"
GLC-599 . . . 8-5/8"
GLC-600 . . . 8-3/4"
GLC-601 . . . 8-7/8"
GLC-602 . . . 9"
GLC-603 . . . 9-1/4"
GLC-604 . . . 9-1/2"
GLC-605 . . . 9-3/4"
GLC-606 . . . 10"
GLC-607 . . . 10-1/8"
GLC-608 . . . 10-1/4"
GLC-609 . . . 10-3/8"
GLC-610 . . . 10-1/2"
GLC-612 . . . 10-3/4"
GLC-613 . . . 10-7/8"
GLC-614 . . . 11"
GLC-615 . . . 11-1/4"
GLC-616 . . . 11-1/2"
GLC-617 . . . 11-3/4"
GLC-618 . . . 12"
GLC-619 . . . 12-1/8"
GLC-620 . . . 12-1/4"
GLC-621 . . . 12-3/8"
GLC-622 . . . 12-1/2"
GLC-623 . . . 12-5/8"
GLC-624 . . . 12-3/4"
GLC-625 . . . 13"
GLC-626 . . . 14"
GLC-627 . . . 14-3/8"
GLC-628 . . . 15"
GLC-629 . . . 15-7/16"
GLC-630 . . . 18"
GLC-631 . . . 18-3/8"

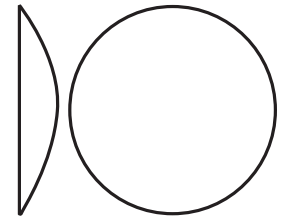

Convex Glass

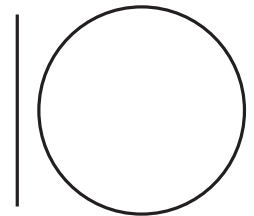

Flat Glass

Revere Glass

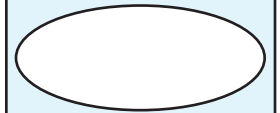

5-13/16"W x 4-1/4"H

Item No.
GLR-501
\$7.50

Flat Glass

Sizes	1	3	12+
2" - 3-7/8"	\$2.25	\$2.10	\$2.00
4" - 5-7/8"	\$3.25	\$3.10	\$3.00
6" - 6-7/8"	\$4.25	\$4.10	\$4.00
7" - 7-7/8"	\$4.75	\$4.60	\$4.50
8-1/8" - 8-1/2"	\$6.25	\$6.10	\$6.00
9" - 9-3/4"	\$6.75	\$6.60	\$6.50
10" - 10-1/2"	\$7.25	\$7.10	\$7.00
11" - 12-1/2"	\$8.75	\$8.60	\$8.50

All glass is approximately 2mm thick.

Convex Glass

Sizes	1	3	12+
2" - 3-15/16"	\$3.25	\$3.00	\$2.75
4" - 5-15/16"	\$4.00	\$3.75	\$3.50
6" - 6-7/8"	\$5.00	\$4.75	\$4.50
7" - 7-7/8"	\$5.25	\$5.00	\$4.75
8" - 8-7/8"	\$11.00	\$10.75	\$10.50
9" - 13"	\$12.00	\$11.50	\$11.00
14"-15-7/16"	\$22.00	\$21.00	\$20.00
18"-18-3/8"	\$23.00	\$22.00	\$21.00

Helpful Hints for choosing the right size glass

Please Note:

Glass needs to fit as close to the front of the bezel as possible without falling through. Make sure to leave room for your mounting option.

Mounting Options:

- Bezel Ring
- Bezel Tabs
- Silicone Gel beading on glass edge.

All prices are subject to change without notice.

Clock Domes & Stands



Glass Domes

Bases not included

Item No.	Size (W x H)	1	3
GLD-34	3" x 4-1/4"	\$4.50	\$4.25
GLD-47	4" x 7"	\$7.95	\$7.75
GLD-48	4-1/2" x 8"	\$11.00	\$10.75
GLD-510	5-1/2" x 10"	\$15.95	\$15.75
GLD-511	5-1/2" x 11"	\$16.95	\$16.75
GLD-810	8" x 10"	\$28.95	\$28.50
GLD-812	8" x 12"	\$29.95	\$29.50
GLD-716	7-1/2" x 16"	\$145.00	

Great Closeouts!

All at Great Prices!

1-of-a-kinds, stock reductions, buy outs, estate items & much more!

Visit our ebay Store

stores.ebay.com/

Ronell-Clock-Company

or Our Website

ronellclock.com



Following sizes include a wood base.

Item No.	Size (W x H)	Price
GLD-513	5-1/2" x 13"	\$30.00
GLD-1015	9-3/4" x 15"	\$89.00
GLD-1020	9-3/4" x 20"	\$99.00
GLD-1215	11-3/4" x 15"	\$109.00
GLD-1223	11-3/4" x 23"	\$114.00
Oval GLD-612	12" x 15" x 6"D	\$100.00

Oval



PLEASE NOTE: Our large domes (8" or larger) are hand blown glass and therefore subject to imperfections such as small bubbles, chill lines, "seeds" and striations. This is the character of hand blown glass that makes it unique. There are no joining seams. Sizes may vary slightly.

Enameled Porcelain Dials



A



B

C



D



E



F



A. Off white, Arabic dial with green & red floral pattern.
4" O.D., 3-5/8" time ring Item No. **DP-102**

B. Off white, Roman dial with red & green floral garland.
4-1/2" O.D., 3-5/8" time ring Item No. **DP-103**

C. Off white, Roman dial with red, blue and gold center design, gold beading & black numerals.
4-1/2" O.D., 3-3/4" time ring Item No. **DP-104**

\$19.95 ea.

D. Off white, Roman dial with dark red fleur-de-lis pattern between each numeral.
4" O.D., 3-1/2" time ring Item No. **DP-105**

E. White, Roman dial, numerals in black.
3-1/4" O.D., 2-1/2" time ring Item No. **DP-106**

F. Off white, Roman dial, numerals in black.
2-1/8" O.D., 1-3/4" time ring Item No. **DP-107**

\$17.95 ea.

May mix styles & sizes for each product to receive quantity discounts.

Dome Bases

May mix sizes & finishes to receive quantity discounts.



3" Dome Diameter

Finish	Item No.	1	3	6+
Polished Brass	GB-30BP	\$8.50	\$8.25	\$8.00
Antiqued Brass	GB-30BS			
Oak	GB-30K	\$6.00	\$5.75	\$5.50
Pewter	GB-30P	\$8.50	\$8.25	\$8.00
Walnut	GB-30W	\$4.00	\$3.75	\$3.50

5-1/2" Dome Diameter

Finish	Item No.	1	3	6+
Antiqued Brass	GB-55BA	\$12.50	\$12.25	\$12.00
Oak	GB-55K	\$8.50	\$7.75	\$7.50
Satin Silver	GB-55S	\$12.50	\$12.25	\$12.00
Walnut	GB-55W	\$6.00	\$5.25	\$5.00

4" Dome Diameter

Finish	Item No.	1	3	6+
Polished Brass	GB-40BP	\$10.00	\$9.75	\$9.50
Satin Brass	GB-40BS			
Oak	GB-40K	\$8.00	\$7.75	\$7.50
Pewter	GB-40P	\$10.00	\$9.75	\$9.50
Walnut	GB-40W	\$6.75	\$6.50	\$6.25

8" Dome Diameter

Finish	Item No.	1	3	6+
Antique Brass	GB-80BA	\$14.50	\$14.25	\$14.00
Polished Brass	GB-80BP	\$14.50	\$14.25	\$14.00
Oak	GB-80K	\$16.50	\$16.00	\$15.50
Satin Silver	GB-80S	\$14.50	\$14.25	\$14.00
Walnut	GB-80W	\$10.00	\$9.75	\$9.50

4-1/2" Dome Diameter

Finish	Item No.	1	3	6+
Polished Brass	GB-45B	\$10.50	\$10.25	\$10.00
Oak	GB-45K	\$7.50	\$7.25	\$7.00
Walnut	GB-45W	\$5.00	\$4.75	\$4.50

New

Brass Pocket Watch Stands



Top and Bottom Mount

For Hunter Style watches
4-1/4" tall with a 2-1/2" square base

Item No. **WH-01** **\$17.95**

Side Mount

For Open Face watches
3-3/4" tall with a 2-1/2" square base

Item No. **WH-02** **\$17.95**



New Dragon Tail Pocket Watch Stands

Cast bronze color hooks with round wood bases. **Watch Not Included.**



Small Stand

4-1/2" tall hook,
4" dia. base

Item No.	Base Wood
WH-40	Walnut
WH-41	Maple
WH-42	Myrtle



Ronell Exclusive

Large Stand

6-1/2" tall hook,
5" dia. base

Item No.	Base Wood
WH-50	Walnut
WH-51	Maple

\$18.95 ea.



Stand with Dome

4-3/4" round base with cast bronze hook. 4"x7" glass dome.

Item No.	Base Wood
WH-60	Walnut
WH-61	Maple
WH-62	Myrtle

\$24.95 ea.

Backboard



Replacements for black mantle clocks. Unfinished wood.

14"W x 8"H

4-13/16" hole. 1/4" thick.

Item No. **PBB-148**

\$5.50 ea.

Back Plate

Reproduction for black mantles & Tambours. With mounting hole and latch. Black finish.

5-1/4" dia. Item No. **PBB-150** **\$3.75**

4-1/2" dia. Item No. **PBB-151** **\$3.50**

3-3/4" dia. Item No. **PBB-152** **\$3.25**



French Movement Mounting Straps

Brass with adjustable screws. 6" long.

Item No. **P-23** **\$5.95** pr.

Wall Stabilizers

May mix styles to receive quantity discounts.



New

HW-25

HW-25 Cast Brass plates. 1-5/8"L, 3/8" dia. knob **\$8.40** pr.



HW-27

HW-27 Brass plated. 2"L, 1" dia. knob **\$5.50** pr. 3 pr. **\$15.00**



HW-28

HW-28 Steel. 1-7/8"L, 1/2" dia. knob **\$6.00** pr. 3 pr. **\$17.25**



HW-29

HW-29 Steel. 1-1/2"L, 3/8" dia. knob **\$3.00** pr. 6 pr. **\$15.00**

New

Wonder Wedge

Stabilize mantle and grandfather clocks. Just slide under clock to fill gap. 6 pcs. per pack.

Item No. **HW-24** **\$2.00** pk.



Leg Levelers

Mounts to bottom of case or cabinet. 1-1/8" dia. plastic knob with 1" threads. Won't mar floors or discolor carpets. 3/4" dia. float x 1/2"H tee nut. 4 pc. set.

Item No. **HW-26** **\$3.25** ea. 4 sets **\$12.00**



New Alderwood Clock Crowns

Unstained, solid wood and veneers.



11"W x 6-1/2"H
Item No. **CR-1-11**
\$27.95



14"W x 7"H
Item No. **CR-1-14**
\$34.95

*Quality made
in the U.S.A.!*



15"W x 8-5/8"H
Item No. **CR-4-15**
\$34.95



8"W x 6-1/4"H
Item No. **CR-5-8**
\$24.95

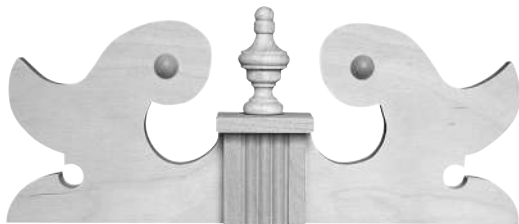

Birch 11"W x 4-3/4"H
Item No. **CR-3-11** **\$24.95**



12-3/4"W x 4-7/8"H
Item No. **CR-6-13** **\$27.95**



12-1/2"W x 8-1/2"H
Item No. **CR-5-12**
\$34.95



Alderwood 7"W x 8"H
Item No. **CR-7-7**
\$24.95

Wooden Clock Bases



5-1/2"W x 3"D x 5"H
Item No. **CB-1-5**
\$29.95



7-3/8"W x 4"D x 6-1/4"H
Item No. **CB-2-7**
\$34.95

Decorative Hardware

New Mantle Feet

Unfinished metal, 2 front & 2 back feet per set. All feet have a 7/8" case elevation.



Front Feet: 2" x 2"
Back Feet: 1" x 1"
Item No. **HW-33**



Back Foot



Front Feet: 2-1/4" x 2-1/4"
Back Feet: 1" x 1"
Item No. **HW-34**



Front Feet: 2-1/2" x 2-1/2"
Back Feet: 1" x 1"
Item No. **HW-35**

\$13.50 set

New Ansonia Statue Clocks and Others

Unfinished metal. 3/4" case elevation. Sold separately.



Item No. **HW-36** **\$9.00** ea.

1-3/16"W x 13/16"H
Item No. **HW-37**
\$5.00 ea.



Mantle Clock Side Arms

3-9/16"H. Unfinished metal.

Item No. **HW-03**
\$4.50 ea.

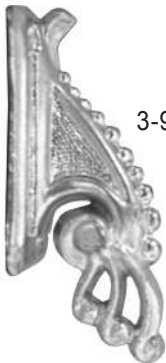

3-1/4"H. Unfinished metal.

Item No. **HW-04**
\$4.00 ea.



Mantle Clock Columns

Cut to fit.

Half Round - Unfinished Metal

1/2"W x 5-1/2"L Item No. **HW-16**

7/8"W x 6"L Item No. **HW-17**

\$2.00 ea.

Full Round Columns

Black finish. 3/4" dia. when closed. 4-3/4"L.

Item No. **HW-18** **\$3.00** ea.



Capitals and Bases

Column top and bottom sets. Metal.

Gold finish.
3/4"W x 3/4"H, 1/2" ID

Item No. **HW-05**

\$2.50 set



Gold finish.
1"W x 1"H, 3/4" ID

Item No. **HW-06**

\$2.50 set



Double set. Unfinished. Top and bottom in a set.
2"W x 3/4"H, 11/16" inside diameter.

Item No. **HW-07** **\$2.75** set



Triple set. Unfinished. Top and bottom in a set.
3-5/8"W x 3/4"H, 11/16" inside diameter.

Item No. **HW-08** **\$3.00** set

Lions Head Pulls

2-5/8"H x 2-1/4"W. Unfinished metal.
2 per set.

Item No. #**HW-02** **\$8.95** set

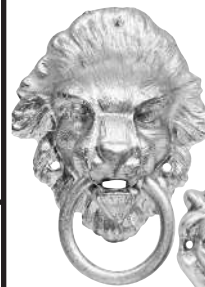

1-1/2"H. Antique,
gold finish. No ring.

Item No. #**HW-02S** **\$2.50** ea.

Movement Bracket Set

For jewelers regulators
and more. Cast Brass.
2-15/16" top, 5" high.

Item No. **HW-44** **\$27.50** pr.

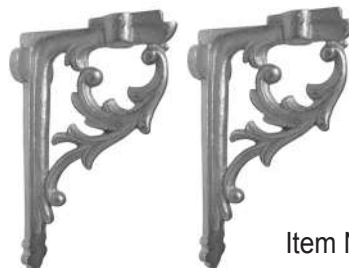



Bracket Clock Handle

Brass finished cast metal,
1-1/2"L threaded post 1-1/2"W x 1-1/2"H
Item No. **HDL-03** **\$4.50**

New

Door Pulls



Antique brass finish, 1"L
Item No. **HDL-05**
\$2.25



Antique brass finish, 1-1/2"L
Item No. **HDL-06**
\$2.25



Polished brass finish
Item No. **C-95**
Antique brass finish
Item No. **C-94**
\$1.00ea.

New

3/4"W x 3/4"H



Antique brass finish, 3/4" dia.
Threaded wood screw.
Item No. **HDL-08** **\$2.25**ea.

Knobs



Bright brass finish, 1/2" dia.
Threaded wood screw.
Item No. **HDL-07** **\$2.25**ea.

Beat Plates



Ansonia
Antique Gold plated.
5-1/2"W x 2-1/8"H.
Item No. **HW-10** **\$7.25**



Regulator
Polished Brass
3-3/4"W x 1-1/2"H
Item No. **HW-11** **\$3.20**



Regulator
Polished Brass
3-1/2"W x 1"H
Item No. **HW-12** **\$3.20**



Vienna Regulator
Polished Brass
3"W x 1-1/4"H
Item No. **HW-13** **\$2.00**



Aluminum
White painted finish
2-15/16"W x 1"H
Item No. **HW-14** **\$3.95**

New Eagle Decorations

Unfinished cast metal.
2-1/2"W x 3/4"H
Item No. **OR-3** **\$2.50**



Unfinished cast metal.
3-3/4"W x 2"H
Item No. **OR-2** **\$2.50**

Antique brass finish.
3-3/8"W x 1-3/4"H
Item No. **OR-1** **\$2.50**



Hangers



HW-20

Brass Plated. 1-1/8" x 1-1/4"H
Item No. **HW-20**
30¢ ea. **\$2.40** doz.



HW-21

Brass Plated. 1-1/4" x 1-1/2"H
Item No. **HW-21**
30¢ ea. **\$2.40** doz.



HW-23

Brass Plated. 1" x 1-3/8"H
Item No. **HW-23**
50¢ ea. **\$4.80** doz.



HW-22

Silver Colored Metal. 2-3/4"L
Item No. **HW-22**
\$1.20 doz. 3 doz. **\$2.88**

Hinges

Fancy Off-Set Hinge



Brass finish. Recess & screw plates.
2-1/8"H x 5/16"W x 1"H. Item No. **HW-30**
\$1.60 ea. 6 for **\$7.20**

Flat Hinges



Brass finish. 3/8" screw plates, 1" high.
Item No. **HW-31**
75¢ ea. **\$6.00** doz.



Brass finish.
1-1/2"H x 1-1/4" W
Item No. **HW-32**
75¢ ea. 4 for **\$2.50**

Door Hardware

New

Escutcheon Plates

New



HW-40



HW-39



HW-41



HW-42

HW-39 Antique Bronze finish. 1-3/4" H x 7/8" W **\$2.75** ea.

HW-40 Cast brass. 2-7/8" H x 3/4" W **\$3.00** ea.

HW-41 Made in England, solid brass. 3" H x 1-1/8" W **\$3.00** ea.

HW-42 Brass plated. 4" H x 1/2" W **\$2.00** ea.

New



Door Key Assortment

Set of 12 keys for door locks. Comes on 2" ring. Different styles & finishes.

Item No. **HKY-12** **\$26.00**

Door Keys



HKY-238



HKY-249



HKY-239



HKY-252

\$2.75 ea. 12+ **\$2.50** ea.



HKY-101



HKY-124

\$3.75 ea. 12+ **\$3.00** ea.

May mix styles & sizes to receive quantity discounts.

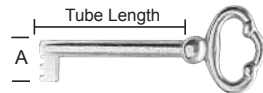

Item No.	Finish	Hole Inside Dia.	A (see diagram)	Tube Length	Overall Length
HKY-101	Pol. Brass	.160"	1/2"	1-7/16"	2-15/16"
HKY-124	Pol. Brass	.150"	1/2"	1-3/4"	3-1/8"
HKY-238	Brass	.150"	3/8"	1-1/2"	2-1/4"
HKY-239	Bronze	.120"	7/16"	1-3/8"	2-3/8"
HKY-249	Brass	.130"	7/16"	1-5/8"	2-1/2"
HKY-252	Brass	.130"	7/16"	1-13/16"	2-3/8"

Lock & Key Sets

New Direct Import!



3 pc set, antique bronze finish.
Lock: 2"H x 1"W x 5/16"D
Key: 2-3/8"L
Escutcheon Plate:
1-3/4"H x 7/8"W

Item No. **HLK-01** **\$5.95**



Blue steel lock. Brass plated key.
Lock: 2"H x 1"W x 5/16"D
Key: 2-1/2"L

Item No. **HLK-02** **\$4.50**



Blue steel lock. Brass plated key.
Lock: 2-3/4"H x 3/4"W x 3/8"D
Key: 2-1/4"L

Item No. **HLK-03** **\$5.95**

Door Latches



School Clock 3 pc. Brass
5/8"L Item No. **HDL-09** **\$2.50**

1"L Item No. **HDL-10** **\$2.75**



O.G. Clock
3 pc. Brass, 1" long.
Item No. **HDL-11** **\$2.75**



Kitchen Clock
Brass, 3/8"W x 1-1/2"L
Item No. **HDL-12** **\$1.00**



Magnetic Bullet Catch
2 pc. 9/16" long, 1/4" dia.
Item No. **HDL-15** **\$1.00**

Hooks & Eye

Brass, 1/4" dia. eye.



Size	Item No.	1	6	12+
1/2"	HDL-13-1	.40	.35	.30
3/4"	HDL-13-2			
1"	HDL-13-3	.50	.45	.40
1-1/2"	HDL-13-4			

May mix styles & sizes to receive quantity discounts.

Pendulums, Bobs, Weights & Accessories

New

Decorative Lyre Pendulums

10-1/2" bob size. Twisted rod pattern, polished brass finish.

See Inside Front Cover
for Full Color Photos

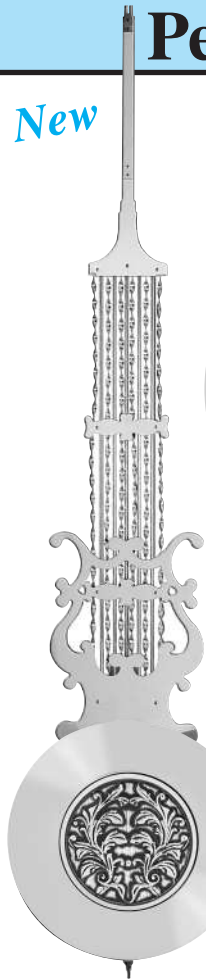

A

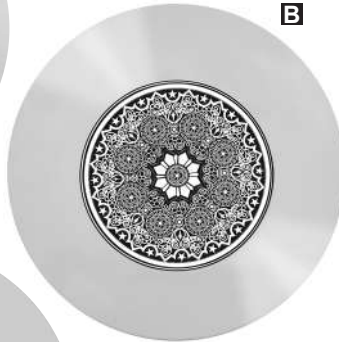

B



C

Two-tone black with cast center.

	Description	Item No.	Size
A	Hermle Laser Etched	PLE-94	94cm
		PLE-114	114cm
	Kieninger Laser Etched	PLE-93	93cm
		PLE-116	116cm
B	Hermle Winter Halder Design	PLW-94	94cm
		PLW-114	114cm
	Kieninger Winter Halder Design	PLW-93	93cm
		PLW-116	116cm
C	Hermle Leaf Pattern	PLL-94	94cm
		PLL-114	114cm
	Kieninger Leaf Pattern	PLL-93	93cm
		PLL-116	116cm

\$99.95 ea. Additional \$5.00 handling fee

CM = Corresponds to the centimeter length engraved in the bottom right corner of the movement plate.

INCHES = Length of the pendulum from the top of the hanger to the bottom of the bob.

Decorative Weight Shells

Sold in sets of 3



WS-12



WS-13



WS-14



WS-15



Item No.	Description	O.D. x Length	Inside Dia.	Finish	Metal	Price
WS-12	Dome Shaped	60 x 310mm 2-3/8" x 12-3/16"	2-1/4"	Polished Brass	Brass	\$79.95
WS-13	Laser etched band	60 x 245mm 2-5/16" x 9-5/8"	2-3/16"	Polished Brass	Aluminum	\$89.95
WS-14	Leaf pattern Embossed black band	60 x 245mm 2-5/16" x 9-5/8"	2-3/16"	Polished Brass	Aluminum	
WS-15	Winter Halder pattern Embossed band	60 x 245mm 2-5/16" x 9-5/8"	2-3/16"	Polished Brass	Aluminum	

Lyre Pendulums

Made in the U.S.A. Polished

Hermle Double Hook

Bob Dia.	Item No.		Rods
	94cm/37"	114cm 44-7/8"	
6-1/2"	PL-H694	PL-H614	Straight
8-5/8"	PL-H894	PL-H814	
10-1/2"	PL-H1094	PL-H1014	Twisted

CM = Corresponds to the centimeter length engraved in the bottom right corner of the movement plate.

INCHES = Length of the pendulum from the top of the hanger to the bottom of the bob.

Kieninger Single Hook

Bob Dia.	Item No.		Rods
	93cm 36-9/16"	116cm 45-5/8"	
6-1/2"	PL-K693	PL-K616	Straight
8-5/8"	PL-K893	PL-K816	
10-1/2"	PL-K1093	PL-K1016	Twisted

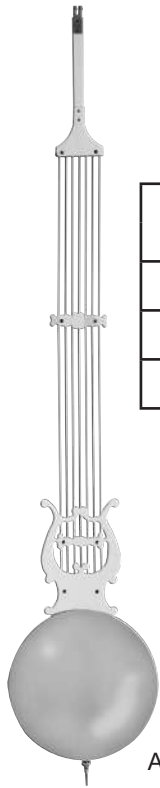

6-1/2" **\$69.00** ea. 8-5/8" **\$79.00** ea.

10-1/2" **\$89.00** ea.

Additional \$5.00 handling fee on these pendulums

Antique Reproduction Paper Dials

Get that 'Old World' Look!

Copied from the original antiques, flaws and all! Weathering, cracking, chips and aging stains. Slight gloss or matt finish on heavy card stock paper, with center hole.

See Back Cover for Full Color Photos



DP-1



DP-2



DP-3



DP-4



DP-5



DP-6



DP-7



DP-9



DP-8
DP-12



DP-10

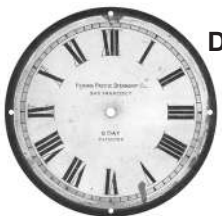

DP-11



DP-13

Code	Dial Color	Time Track Dia.	Outside Dia.	1	6	12+
DP-1	Antique white, gray center	2-5/16"	2-7/16"	\$3.00	\$2.75	\$2.50
DP-2	Antique ivory, gold ring					
DP-3	Antique black, ivory rings & numerals					
DP-4	2 tone: antique beige & light brown	2-3/4"	3-1/4"	\$3.95	\$3.75	\$3.50
DP-5	Antique ivory, light brown ring	4-1/8"	4-1/2"			
DP-6	Antique beige, antique black ring	5-1/16"	6"			
DP-7	Antique ivory, black ring & green time					
DP-8	Black, rust colored numerals	7-3/4"	9"			
DP-9	Antique white					
DP-10	Antique ivory, multi colored flags, green ocean, brown numerals					
DP-11	Antique ivory, black ring, gold time ring	8"				
DP-12	Black, rust colored numerals					
DP-13	Antiqued beige, dark brown numerals & words	8"				

May mix styles & sizes to receive quantity discounts.

Lyre Pendulum Necks

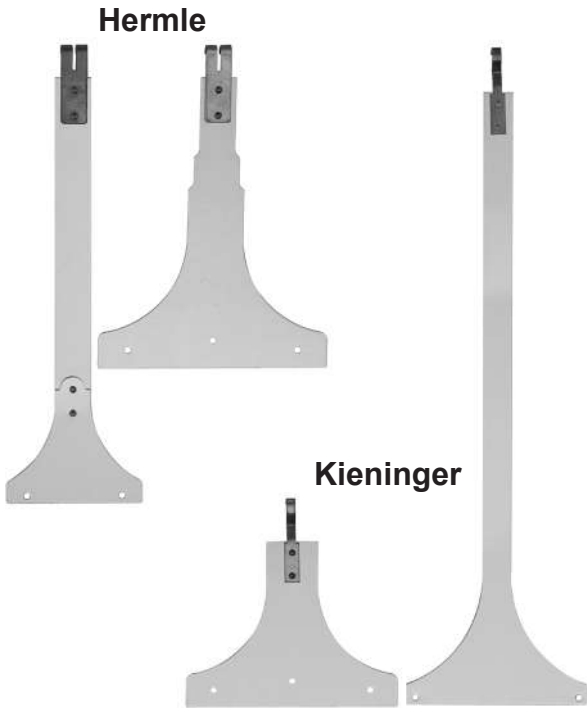

Hermle

Brass plated, polished finish, double hook.

Bob Dia.	Pendulum Size	Neck Length	Bottom Width	Screw Hole Spread	Item No.	Price
6-1/2"	94cm	7"	2-1/8"	1-1/2" 2 Holes	PN-H694	\$9.95
	114cm	12-3/4"			PN-H614	
8-5/8"	94cm	4-3/4"	3-1/8"	2-13/16" 2 Holes	PN-H894	
	114cm	12"			PN-H814	
10-1/2"	94cm	5"	3-9/16"	1-5/16" 3 Holes	PN-H1094	
	114cm	12"			PN-H1014	

Kieninger

Brass plated, polished finish, single hook.

Bob Dia.	Pendulum Size	Neck Length	Bottom Width	Screw Hole Spread	Item No.	Price
6-1/2"	93cm	4-3/8"	2-1/8"	1-1/2" 2 Holes	PN-K693	\$9.95
	116cm	13"			PN-K616	
8-5/8"	93cm	3"	3-1/8"	2-13/16" 2 Holes	PN-K893	
	116cm	11-1/4"			PN-K816	
10-1/2"	93cm	3-1/2"	3-9/16"	1-5/16" 3 Holes	PN-K1093	
	116cm	11"			PN-K1016	

CM = Corresponds to the centimeter length engraved in the bottom right corner of the movement plate.



Kieninger Lyre Pendulum Neck Piece

Length	Screw Holes	Item No.	Price
7-1/2"	2-7/8" apart	PN-01	\$6.00
11-3/4"		PN-02	\$7.00

Lyre Pendulum Bobs

Polished, Made In U.S.A

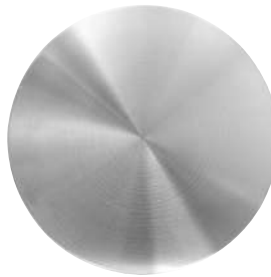

Bob	Item No.	Price
6-1/2"	PB-6L	\$26.95
8-5/8"	PB-8L	\$32.95
10-1/2"	PB-10L	\$39.95

Lyre Pendulum Center Rods with Rating Nut



Item No. **PLA-6** Grandmother - 32" long
 Item No. **PLA-7** Grandfather - 32-1/4" long **\$11.95** ea.

Lyre Pendulum Neck Screws

Pack of 4, gold-tone



Item No. **PLA-4**
\$1.00 pkg.

Upper Rod Holders

For Lyre Pendulums. Plastic

\$3.95 ea.



Item No. **PLA-1** 2" wide, 7 holes



Item No. **PLA-2** 3" wide, 9 slots



Item No. **PLA-3** 3-1/2" wide, 11 slots

Grandmother & Grandfather Weight Shells

Price includes: One Weight Shell
Complete with Caps, Rod, Hook, & Bottom Nut
Lead Inserts NOT Included



New
New
New

Item No.	Outside Dia. x Length	Inside Diameter	Finish	Metal	Price
WS-1	42 x 233mm (1-5/8" x 9-1/4")	38mm (1-1/2")	Polished	Aluminum	\$12.00
WS-2	47 x 273mm (1-7/8" x 10-3/4")	43mm (1-11/16")			\$18.00
WS-3	60 x 245mm (2-5/16" x 9-5/8")	55mm (2-3/16")			\$18.00
WS-4	60 x 245mm (2-5/16" x 9-5/8")	55mm (2-3/16")	Brushed	Aluminum	\$18.00
WS-5	45 x 272mm (1-11/16" x 10-5/8")	43mm (1-9/16")		Solid Brass	
WS-6	50 x 260mm (2" x 10-1/4")	48mm (1-15/16")			
WS-7	64 x 245mm (2-5/16" x 9-5/8")	61mm (2-3/8")	Polished	Solid Brass	\$18.00
WS-8	45 x 272mm (1-11/16" x 10-5/8")	43mm (1-9/16")			
WS-9	50 x 260mm (2" x 10-1/4")	48mm (1-15/16")			
WS-10	63 x 245mm (2-7/16" x 9-5/8")	61mm (2-3/8")			
WS-11	63 X 284mm (2-7/16" X 11-3/16")	61mm (2-3/8")			\$19.00



Weight Shell Caps

Aluminum			
47mm	Polished	WS-2C	\$3.60
60mm		WS-3C	

Solid Brass			
	Brushed	Polished	
47mm	WS-5C	WS-8C	\$3.60
50mm	WS-6C	WS-9C	
63mm	WS-7C	WS-10C	

Weight Hooks & Bottoms - Brass

Hermle for Grandfather & Grandmother

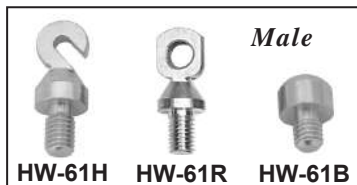

Male

HW-61H **HW-61R** **HW-61B**

95¢ea. 6+ **90¢**ea.



Female

HW-62H **HW-62R** **HW-62B**

For Viennas



HW-62V **HW-61V** **HW-62VS**

\$2.25ea. 6+ **\$2.00**ea.

Kienninger



HW-61KH **HW-61KB**
\$1.50ea. **\$1.00**ea.

6+ **\$1.35**ea. 6+ **90¢**ea.



Lead Weight Donuts

Get the exact weight you need for your weight shells.
Pre-drilled center hole of 3/16" diameter. Can be slightly
shaved down to fit weight shells.

WSL-31



WSL-05, 15



WSL-12

New

Item No.	Weight	1	12+
WSL-05	1/2 Lb. 1-3/4" x 1/2"H	\$2.50	\$2.25
WSL-15	1 Lb. 1-1/2" x 1-9/16"H	\$3.95	\$3.70
WSL-12	1 Lb. 2" x 13/16"H		
WSL-31	3-1/2 Lb. 1-5/8" x 4-1/4"H	\$13.75	\$12.75

May mix styles & sizes for each product to receive quantity discounts.

Cables, Pulleys & Accessories



Urgos Pre-Cut Cable

Ready to install. With brass end fittings. Sold individually - 1 cable per package.

Length	Thickness	Material	Item No.	Price
52"	.035"	Brass	CA-300	\$5.00
106"	.040"	Brass	CA-301	\$5.95



Hermle Brass Pre-Cut Cable

Ready to install. With brass end fittings. Sold individually - 1 cable per package.

Length	Thickness	Application	Item No.	Price
53-1/2"	.040"	For mvts. #351 & #781	CA-101	\$5.95
77"	.040"	For mvts. before 1986	CA-102	
89"	.040"	For mvts. 1986 to present	CA-103	
106"	.040"	For mvts. #471 & #1171	CA-104	



Kieninger Pre-Cut Cable

Ready to install. With brass end fittings. Sold individually - 1 cable per package.

Length	Thickness	Application	Item No.	Price
51"	.032"	Bronze	CA-201	\$5.50
76"	.032"	Brass	CA-202	\$5.75

20pc. Brass Cable End Fittings

Assortment for Hermle, Kieninger and Urgos cables.

New

Item No. CA-400 \$5.50 set



Hermle Cable Guard

1-7/8" dia., plastic.

Item No. CAG-403 \$3.25 ea.



Kieninger Cable Guards

1-3/4" dia., plastic. Item No. CAG-404 \$2.50 ea.

2-1/4" dia., plastic. Item No. CAG-405 \$2.50 ea.



Brass Cable



New

New

Thickness	MM	Max Wt.	Item No.	Price per foot
1/32"	.80	40lb.	CA-132	35¢ per ft.
.040"	1.0	60lb.	CA-040	\$25.00 per 100 ft.
3/64"	1.19	85lb.	CA-364	50¢ per ft. \$45.00 per 100 ft.
1/16"	1.59	150lb.	CA-116	
5/64"	1.98	300lb.	CA-564	

Cable Pulleys

New

PP-132



New

PP-133



PP-134



PP-136



PP-137









PP-138



Item No.	Description	Dia.	Price Ea.
PP-132	5 Spoke Vienna Hi quality, German made.	1-7/8"	\$12.95
PP-133	Universal	1-1/2"	\$8.00
PP-134	Hermle-Kieninger	1-3/4"	\$13.50
PP-136	Fancy Vienna Requires Finishing	1-1/8"	\$7.50
PP-137	4 Spoke Vienna Requires Finishing	1-1/8"	\$5.75
PP-138	5 Spoke Vienna Requires Finishing	1-1/8"	\$6.50

Chains

A = Antique Brass B = Solid Brass P = Brass Plated

Sample	Wire Thickness MM	Links Per Foot	Length	Material	Item #	1 Price per chain	2+ Price per chain
	.70	66	72"	B	CH-07066	\$4.00	\$3.75
	.70	72	72"	P	CH-07072	\$4.00	\$3.75
	1.05	53	72"	B	CH-10553	\$4.75	\$4.50
	1.20	52	72"	P	CH-12052	\$7.00	\$6.75
	1.50	46	72"	B	CH-15047	\$11.50	\$11.25
	1.70	46	55"	P	CH-17046	\$9.75	\$9.50
	1.70	46	56"	A	CH-17046A	\$10.75	\$10.50

Kieninger Chain



1.60mm wire thickness, 38 links per foot. 62" long.

Item No. **CH-16038** **\$10.00** per chain

Kieninger SK Movement Chain



1.60mm wire thickness, 45 links per foot. 55" long.

Item No. **CH-16045** **\$10.00** per chain

Hermle Chain



For series #241, 451, 461, 1151, 1161. Complete with hook & stop plate. 1.70mm wire thickness, 47 links per foot. 57" long.

Item No. **CH-17057** **\$12.50** per chain

36" Decorative Chain



Brass finish with hook & tab. 1.50mm wire thickness.

Item No. **CH-1** **\$2.50** per chain

Chain Hook, Ring and Tab

For wall and floor clocks. Price includes one of each piece.

Item No. **HW-75** **\$2.50**



Cuckoo Chain

Complete with hooks and rings



Regula 1-Day #25

.90mm wire thickness, 61 links per foot. 70" long.

Brass Plated - Item No. **CH-9063** **\$6.95** pr.

Antiqued Brass - Item No. **CH-9063A** **\$9.95** pr.



Regula 8-Day #34

1.05mm wire thickness, 48 links per foot. 70" long.

Brass Plated - Item No. **CH-10547** **\$7.95** pr.

Antiqued Brass - Item No. **CH-10547A** **\$15.95** pr.



Hubert Herr #60 & #75 1-Day

.90mm wire thickness, 59 links per foot. Brass plated. 78" long.

Item No. **CH-9059** **\$7.75** ea.



Hubert Herr #80 8-Day

1.30mm wire thickness, 45 links per foot. Brass plated. 70" long.

Item No. **CH-13045** **\$10.50** ea.

May mix styles & sizes to receive quantity discounts.

Pendulums

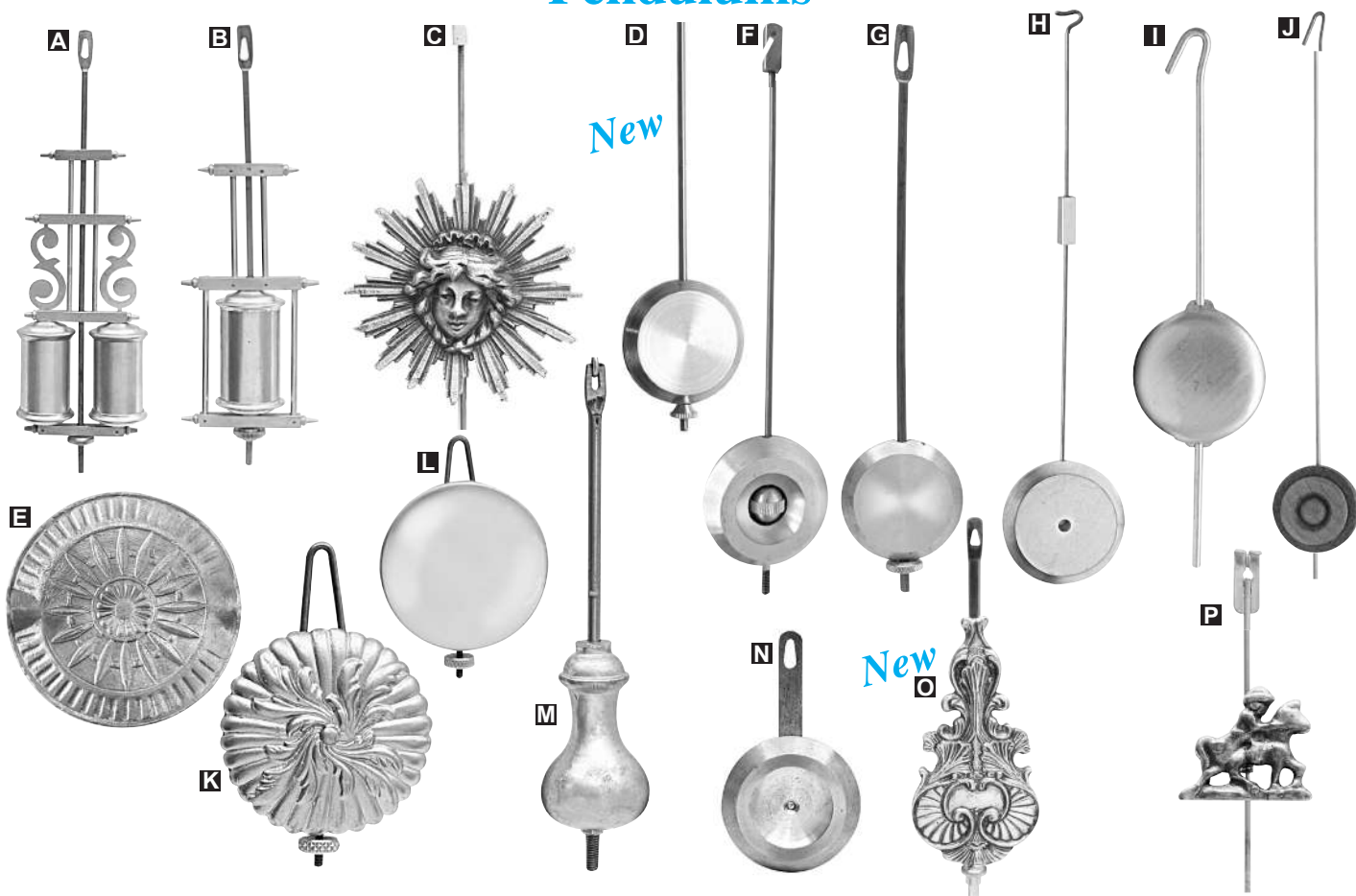

New

New

- A. Double Barrel.** Solid brass. For kitchen and mantle clocks. 7-3/4"L x 2-3/4"W. Item No. **PM-20** **\$21.50**
- B. Single Barrel.** Solid brass. For kitchen and mantle clocks. 6-1/2"L x 1-1/2"W. Item No. **PM-21** **\$15.00**
- C. French Sunburst.** 12" steel rods. Hook included.
 1-1/2" Bob Antique Brass, 1-1/2oz. **PM-22-1** **\$12.00**
 2" Bob Antique Brass, 2-1/2oz. **PM-22-2** **\$13.50**
 3" Bob Brass, 3-1/2oz. **PM-23** **\$13.75**
- D. Universal French.** 1-3/8" dia. brass bob. 9-1/4"L threaded rod. Slotted french pendulum hook. Can be shortened and & hook solders in place. Item No. **PM-29** **\$12.50**
- E. Seth Thomas Bob & Rods.** Sold separately. 2-7/16" dia., 3-1/2 oz. bob. Oval shaped rod. Regulating nut included.
 Bob Item No. **PM-30** **\$7.95**
 3-3/4" Rod Item No. **PM-31** **\$3.75**
 4-3/4" Rod Item No. **PM-32** **\$3.75**
 6-1/4" Rod Item No. **PM-33** **\$3.75**
- F. French.** Solid brass bob. 11-3/4" steel rod. Hook included.
 1-1/4" Bob Item No. **PM-34**
 1-3/8" Bob Item No. **PM-35** **\$14.50** ea.
 1-1/2" Bob Item No. **PM-36**
- G. Universal.** Brass. 2-1/2" oz. 6-5/8"L x 1-3/8" dia. bob. Item No. **PM-37** **\$11.50**
- H. Silk Thread.** For French clocks. 11-3/8"L x 1-1/4" dia. bob. Item No. **PM-38** **\$7.75**
- I. Adjustable Zapper.** Brass colored. 6"L x 5/8" dia. bob. Item No. **PM-39** **\$1.20** ea. 12+ **\$1.00** ea.
- J. Novelty.** Wood, 7/8" dia. bob. 7-1/2" long wire rod. Item No. **PM-40** **\$1.50** ea. 12+ **\$1.25** ea.
- K. Waterbury.** Reproduction. Swirling leaves. 2-1/2" oz. 1-5/8" dia. bob. Item No. **PM-47** **\$4.75**
- L. Adjustable.** Brass with lead back. Wire rod & rating nut.
 1-1/2" dia. 2 oz. Item No. **PM-60**
 1-3/4" dia. 2-1/2 oz. Item No. **PM-61** **\$6.75** ea.
 2" dia. 3 oz. Item No. **PM-62**
 2-1/4" dia. 4 oz. Item No. **PM-63**
- M. Morbier Chain.** 35"L chain. 1-1/4" dia. x 2-1/4"L lead bob and rating nut. 8-1/2 oz. Item No. **PM-19** **\$21.95**
- N. New Haven Adjustable Bob.** 1-1/2" dia. cast bob with 2-1/2" adjustable flat sided steel rod. 1-3/4 oz. Item No. **PM-46** **\$6.50**
- O. Kitchen Clock.** 6" long rod. 2-1/8"w x 4-1/8" bob. Solid brass casting with rating nut. 3-1/2 oz. Item No. **PM-41** **\$8.95**
- P. Zandam.** Cast bob with antique brass finish. 1-1/2" W. 8-1/2" rod with hook. 1 oz. Item No. **PM-18** **\$10.50**

Cast Metal Reproduction Bobs Non-Adjustable. For Mantle Clocks



Sessions
3 oz.,
silver, 1-1/2" dia.
Item No. **PM-48**



Sessions
1-1/2 oz.,
silver, 1-3/8" dia.
Item No. **PM-49**



Ingraham
2-1/4 oz.,
silver, 1-1/2" dia.
Item No. **PM-50**



Leaf / Trellis
Old Ingraham, 2-1/2 oz.,
gold, 1-5/8" dia.
Item No. **PM-51**



New Ingraham
2-1/4 oz.,
gold, 1-9/16" dia.
Item No. **PM-52**



Waterbury
1-1/2 oz.,
silver, 1-5/8" dia.
Item No. **PM-53**



Seth Thomas
5 oz.,
gold, 1-3/4" dia.
Item No. **PM-54**



Boy on Fence
Seth Thomas, 4 oz.,
gold, 1-5/8" dia.
Item No. **PM-55**



Center Hole
Seth Thomas, 4-1/2 oz.,
gold, 1-13/16" dia.
Item No. **PM-56**



Rimmed Convex
2-1/2 oz.,
gold, 1-9/16" dia.
Item No. **PM-57**



Flower
2 oz.,
gold, 1-1/2" dia.
Item No. **PM-58**



Curved Rim
3 oz.,
gold, 1-5/8" dia.
Item No. **PM-59**

\$4.00 ea. 12 for **\$42.00** (\$3.50 ea.)

May mix styles to receive quantity discounts.

Solid Brass Bobs

Available in Polished or Brushed finished.

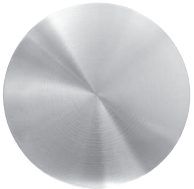

Size	Stick Width	Polished Item No.	Brush Item No.	Price
3-1/8"	3/4"	PB-01	PB-02	\$7.95
4-1/2"	3/4"	PB-03	PB-04	\$10.95
5-1/2"	3/4"	PB-05	PB-06	\$14.95
6-1/2"	1"	PB-07	PB-08	\$18.95

Bob Wires



\$1.50 ea. 6+ **\$1.25** ea.

2-3/8" - Item No. **PW-238**
3-1/4" - Item No. **PW-314**
4-1/4" - Item No. **PW-414**

Regulating Nuts



Item No. **PA-14**
\$1.25 ea.



Item No. **PA-15**
\$1.00 ea.

New

Vienna Regulator Bob



5-3/4" dia. 13 oz., solid brass front, 3/4" slotted steel back.
Item No. **PB-11** **\$19.95** ea.

Tall Case Bob



4-1/2" dia. 1lb., 6 oz., solid brass front, cast lead back.
Item No. **PB-09** **\$24.95** ea.

New Store Regulator Bob

Brass plated bob with 5/8" slotted back. 4-1/2" dia., 6.2oz.
Item No. **PB-12** **\$15.95** ea.

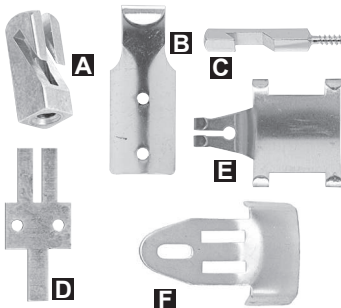

- A. French Hook** Brass, #3, 48 thread - **PA-18** **\$1.75** 6 for **\$9.00**
- Large French Hook** Brass, #4, 40 thread - **PA-17** **\$2.25**
- B. Kieninger Hook** Brass - **PA-23** **\$1.75**
- C. French Hook & Screw** Brass, also works on Kieninger pend. - **PA-19** **\$3.50** 3 for **\$8.25**
- D. Universal Hook** Brass, 5/8" wide - **PA-22** **\$1.25** 3 for **\$1.00** ea.
- E. Hermle Hook** Brass. Grandmother - **PA-20** Grandfather - **PA-21** **\$1.25** 12 for **\$12.00**
- F. Urgos Hook** Grandmother **PA-24** **New** **\$1.50** 3 for **\$1.25** ea.

May mix styles to receive quantity discounts.

Pendulum Leaders

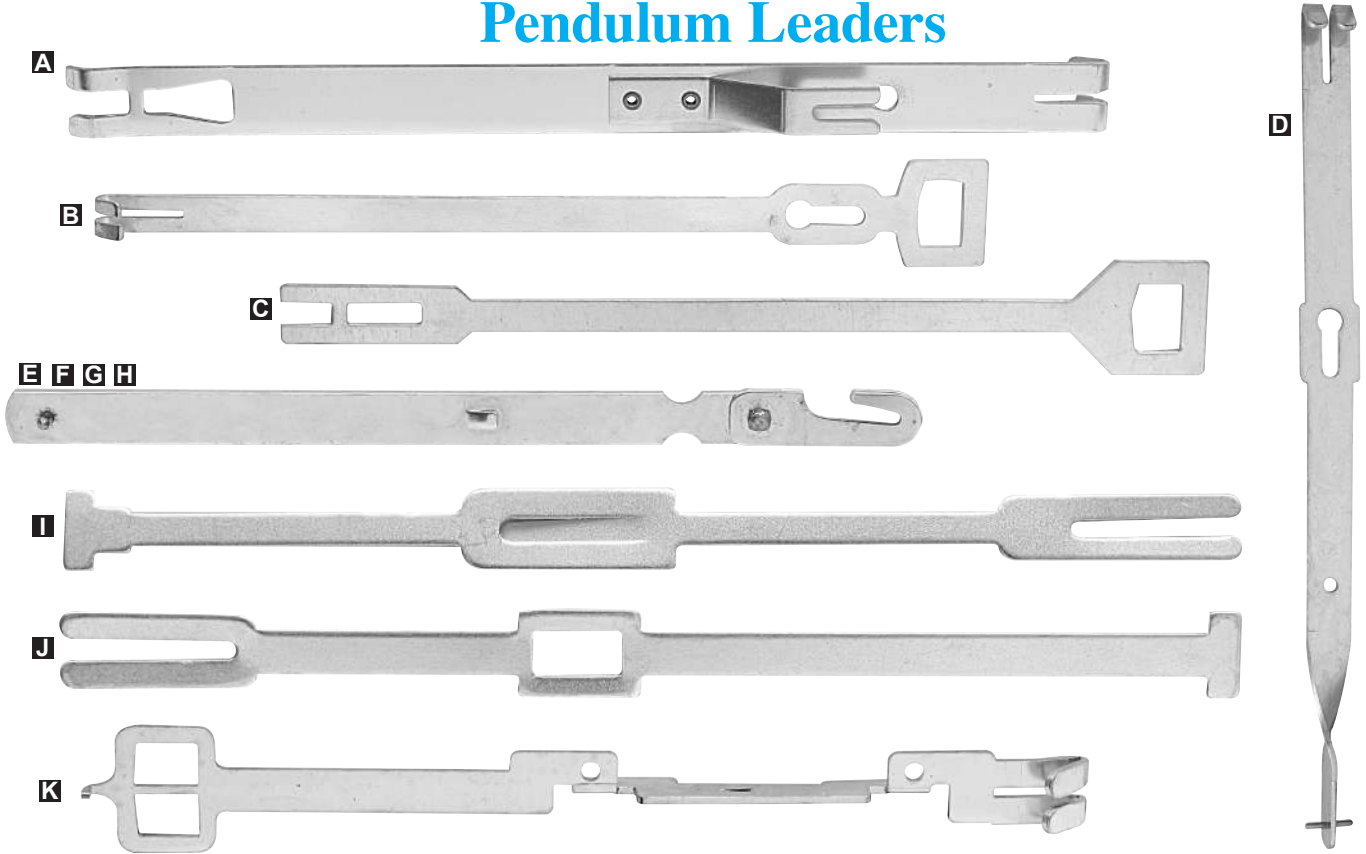

- A. Kienerger** Large, Grandfather. Automatic beat. 1-1/2" from top to center of crutch hole. 7" Long. Item No. **PMH-0444** **\$8.95**
- Kienerger** Small, wall clock. Automatic beat. 2" from top to center of crutch hole. 4-5/8" Long. Item No. **PMH-045** **\$8.95**
- B. Urgos** Old style Grandfather. 5-3/4" from top to center of crutch hole. 7" Long. Item No. **PMH-050** **\$5.00**
- C. Urgos** New style Grandfather. Automatic beat. 6-15/16"L. Item No. **PMH-051** **\$5.00**
- D. Hermle** Automatic beat. 2-1/4" from top to center of crutch hole. 5-3/8" Long. Item No. **PMH-1660** **\$8.95**
- E. Hermle** 2-1/8" Long. Item No. **PMH-0710** **\$6.50**
- F. Hermle** 3-1/4" Long. Item No. **PMH-1340** **\$6.50**
- G. Hermle** 5-5/8" Long. Item No. **PMH-1180** **\$7.00**
- H. Hermle** 6-7/8" Long. Item No. **PMH-0780** **\$7.00**
- I. Generic** For German, Engl. & Amer. clocks. 2-1/2" from top to center of crutch hole. 4-1/2"L. Item No. **PMH-021** **\$2.75**
- J. Generic** For German, Engl. & Amer. clocks. 1-1/2" from top to center of crutch hole. 4-1/4"L. Item No. **PMH-025** **\$2.75**
- K. Hermle** Fits 451 series. 4-3/8" Long. Item No. **PMH-6810** **\$7.00**

Wooden Pendulum Sticks



Unfinished wood with brass colored pendulum hanger, rating stem & nut.

Length	Width	Item No.	Price ea.
21"	3/4"	PS-21	\$7.00
29"	3/4"	PS-29	\$8.50
39"	3/4"	PS-39	\$10.95
40"	1"	PS-40	\$11.95

New Pendulum Stick



Shop regulator, black, 14-1/4" long x 5/8" wide, with rating assembly and hook.

Item No. **PS-14** **\$9.50**ea.

Pendulum Sticks

36" long, unstained, stick only



Width	Item No.	Price ea.
3/4"	PS-36-34	\$5.95
1"	PS-36-1	\$5.95

Rating Nut and Threaded Stem



3-1/2" Long Item No. **PA-9** **\$3.00**set

Suspension Springs

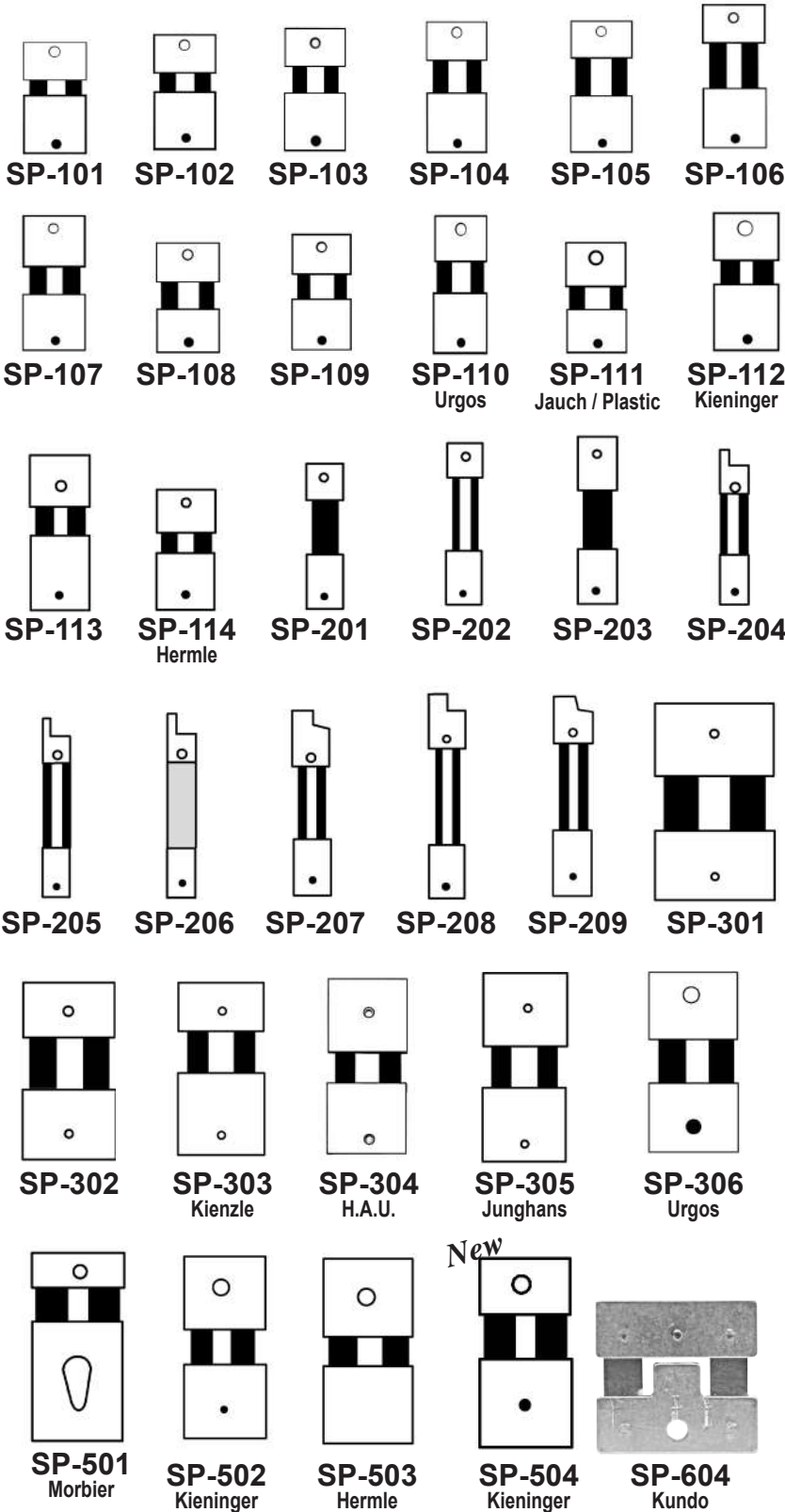

ITEM NO.	MFG #	SIZE: L x W mm	SPRING THICKNESS	1-11	12+
SP-101	#2	15.5 x 8.0	0.04mm	\$2.25	\$2.00
SP-102	#3	16.5 x 8.0	0.05mm		
SP-103	#4	17.5 x 8.0	0.05mm		
SP-104	#5	18.5 x 8.0	0.05mm		
SP-105	#6	19.5 x 8.0	0.06mm		
SP-106	#7	20.0 x 8.0	0.06mm		
SP-107	#8	18.0 x 8.0	0.05mm		
SP-108	#9	15.0 x 8.0	0.05mm		
SP-109	#10	17.0 x 8.0	0.05mm		
SP-110	#202	18.0 x 8.0	0.04mm		
SP-111	#204	14.5 x 8.0	0.04mm		
SP-112	#306	17.5 x 8.0	0.07mm		
SP-113	#12	21.25 x 8.0	0.05mm		
SP-114	#307	17.25 x 8.0	0.05mm		
SP-201	#27	22.0 x 5.0	0.04mm	\$4.75	\$4.25
SP-202	#28	23.0 x 5.0	0.05mm		
SP-203	#29	21.75 x 5.0	0.05mm		
SP-204	#130	22.5 x 4.0	0.05mm		
SP-205	#131	25.5 x 4.0	0.05mm		
SP-206	#132	25.5 x 4.0	0.05mm		
SP-207	#311	25.0 x 5.0	0.05mm		
SP-208	#312	28.5 x 5.0	0.06mm		
SP-209	#313	31.5 x 6.0	0.06mm		
SP-301	#41	27.5 x 17.0	0.07mm		
SP-302	#42	25.0 x 14.0	0.07mm		
SP-303	#43	28.0 x 14.25	0.07mm		
SP-304	#45	25.0 x 12.0	0.06mm		
SP-305	#46	26.5 x 12.0	0.06mm		
SP-306	#301	25.5 x 11.0	0.06mm	1-2	3+
SP-401	#4402	28.25 x 8.25	0.10mm	\$9.50	\$8.75
SP-402	#4710	43.5 x 11.5	0.10mm		
SP-501	#308	24.5 x 12.0	0.07mm	\$6.50	\$6.00
SP-502	#304	25.25 x 12.0	0.10mm	\$5.75	\$5.50
SP-503	#303	26.0 x 11.0	0.06mm		
SP-504	#305	24.0 x 12.0	0.10mm	\$5.75	\$5.50
SP-604	#54	16.25 x 17.0	0.04mm	\$16.50	\$15.50
SP-609	#18	65.0 x 6.0	0.10mm	\$5.50	\$5.00

Urgos - Self Adjusting Plastic.

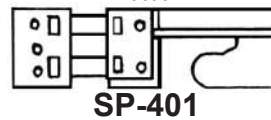

SP-401

SP-609

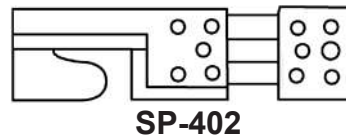

SP-402

New



Ansonia Swinger Suspension Assembly

Brass, steel springs. Complete.

Item No. **SP-505** **\$39.00**

New



5pc. Ansonia & French Swinger Springs

5pc. Ansonia & French swinger springs.

.004" **SP-506**
.007" **SP-507** **\$4.50** pk.

May mix styles & sizes to receive quantity discounts.

Suspension Springs

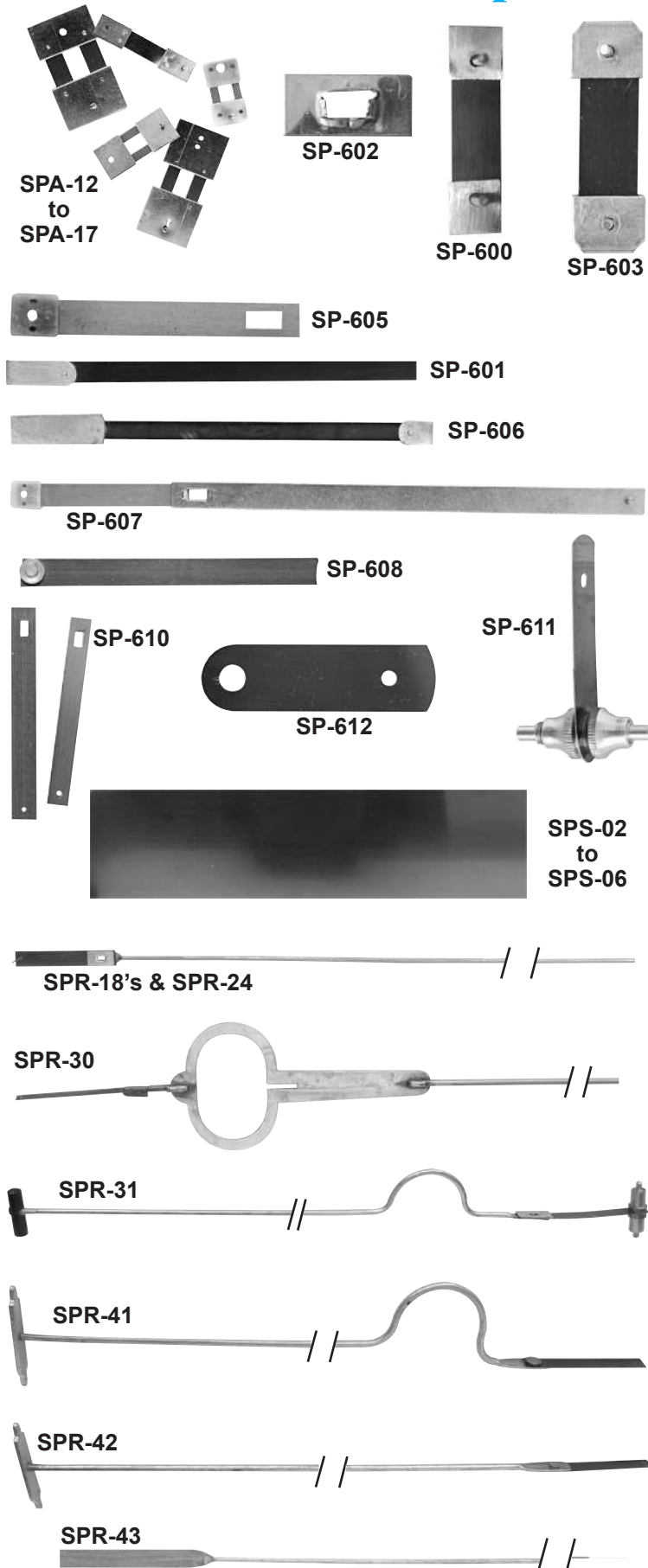

ITEM NO.	DESCRIPTION	Price
SPA-12	Wall, Mantle & Floor Assort. 12pc., most popular sizes ranging from light weight to large heavy duty.	\$35.50
SPA-13	Small Sizes Assort. 12pc., for wall regulators to grandmother clocks. One of our best sellers.	\$25.50
SPA-14	French, Mantle & Shelf Assort. 12pc.	\$45.50
SPA-15	Hermle Assort. 10pc. small to large sizes for Hermle mantle, wall, grandmother & grandfather movements.	\$35.50
SPA-17	Kieninger Assort. 10pc., small to large sizes for Kieninger mantle, wall, grandmother & grandfather movements.	\$35.50
SP-600	Jewelers Regulator. 1-1/2" L, .11mm thick.	\$4.00 3+ \$3.50ea.
SP-601	Grandfather 5" long. 7/8" brass end piece. .006" thick.	\$5.00
SP-602	Joining piece.	\$1.00 \$9.50dz.
SP-603	#2 Regulator. 1-3/16" long, .0025"	\$3.25 3+ \$3.00ea.
SP-605	(#100) 37mm x 4mm, .05mm thickness	\$2.25 3+ \$2.00ea.
SP-606	Grandfather. 5-3/8", .2mm thickness	\$5.95 3+ \$5.00ea.
SP-607	(#105) 4-3/8" long, .05mm thickness	\$6.00 3+ \$5.00ea.
SP-608	Fusee w/ Brass Rivet. 5W x 51L (mm) .09mm thick	\$3.50 3+ \$3.00ea.
SP-610	25pc. assort. American susp. spring feathers. 3/16" - 1/4" W, 1-7/16 - 2" L, .005 & .006 thick	\$4.50pk.
SP-611	Herschede , with top mount screws	\$7.50
SP-612	Herschede hall clocks, .006" thick steel, 1-3/4" L x 1/2" W	\$4.00
SPS-02 SPS-04 SPS-05 SPS-06	Suspension Steel Sheets 6" x 1-1/2" .002" thickness .004" thickness .005" thickness .006" thickness	\$4.25 3+ \$4.00ea.
SPR-18-2 SPR-18-3 SPR-18-4 SPR-24-4	American. 12pc. bundle 18" length, .002" thickness, 1-1/8" suspension 18" length, .003" thickness, 1-1/8" suspension 18" length, .004" thickness, 1-1/8" suspension 24" length, .004" thickness, 1-1/8" suspension	\$6.25dz. \$6.25dz. \$4.25dz. \$10.50dz.
SPR-30	Seth Thomas Style Suspension Unit 15-1/2" overall length, 1-3/8" spring for S.T. #89 movement	\$6.50
SPR-31	31 Day. For Chinese, Korean & Japanese clocks. 1-3/8" suspension, 12" overall length	\$3.50
SPR-41	Bent Front Mount American 1" suspension. 11" overall length.	\$3.50
SPR-42	Straight Back Mount American 1" suspension. 12" overall length.	\$3.50
SPR-43	Old Style One Piece 12pc. bundle. .005 thickness. 24" overall length.	\$9.00dz.

400 Day Top & Bottom Blocks and Forks



Top Block #1
(8x7.5mm)
Item No. **SPB-01T**



Top Block #2
(8x6mm)
Item No. **SPB-02T**



Top Block #3
(6x5mm)
Item No. **SPB-03T**



Fork #1
(16mm long)
Item No. **SPF-01**



Fork #2
(13mm long)
Item No. **SPF-02**



Fork EK
(8mm long)
Item No. **SPF-03**



Bottom Block #1
(8x7.5mm)
Item No. **SPB-01B**



Bottom Block #2
(8x6mm)
Item No. **SPB-02B**

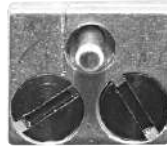

Bottom Block #3
(6x5mm)
Item No. **SPB-03B**



Fork EH
(12mm long)
Item No. **SPF-04**



Fork EN
(14mm long)
Item No. **SPF-05**



Fork MK
(13mm long)
Item No. **SPF-06**

\$8.25 ea. 6+ **\$7.75** ea.

May mix styles & sizes for each product to receive quantity discounts.

Inches	MM	Item No.
.0018	.046	SPW-18
.0019	.048	SPW-19
.0020	.051	SPW-20
.0021	.053	SPW-21
.0022	.056	SPW-22
.0023	.058	SPW-23
.0024	.061	SPW-24
.0025	.064	SPW-25
.0026	.066	SPW-26
.0028	.071	SPW-28
.0030	.076	SPW-30
.0031	.079	SPW-31
.0032	.081	SPW-32
.0033	.084	SPW-33
.0034	.086	SPW-34
.0035	.089	SPW-35
.0036	.091	SPW-36
.0037	.094	SPW-37
.0038	.097	SPW-38
.0040	.102	SPW-40
.0045	.114	SPW-45
.0050	.127	SPW-50
.0055	.140	SPW-55
.0060	.152	SPW-60

Horolovar Wires

Individual 400 Day Wires

Packets Contain
3 Wires of One Size

\$4.75 pk.

3pks.+

\$4.25 ea.



THE HOROLOVAR COMPANY
12 ASSORTED POPULAR STRENGTHS

USE GENUINE HOROLOVAR® PENDULUM SUSPENSION SPRINGS FOR THE BEST REGULATION AND LONGEST LIFE

WHY LEGAL BRONZE OR STEEL SUSPENSION SPRINGS MAKE REGULATION DIFFICULT

Changes in room temperature seriously affect the rate of the pendulum cycle of the clock as evidenced with a bronze or steel suspension spring. When the temperature increases, for instance, these things happen: (1) the suspension spring expands in all dimensions (2) the pendulum bob expands and (3) the suspension spring braces part of its surface. The net result is that the clock slows down. When the temperature decreases, the effect is reversed and the clock speeds up.

HOW HOROLOVAR® SUSPENSION SPRINGS IMPROVE REGULATION

Horolovar® suspension springs are made of an extraordinary alloy known as the "Span" 57°+/- .001. This alloy spring stiffness is automatically controlled for any change in temperature. In addition, the control in the Horolovar® spring has been set to compensate for expansion or contraction of the pendulum bob. As a result when a 400 Day Clock is equipped with a Horolovar® suspension spring, temperature change will not change the rate of the pendulum cycle. Clock regulated, the clock will keep accurate time.

HOROLOVAR® SUSPENSION SPRINGS WON'T BREAK

Horolovar® springs have very high tensile strength, high fatigue strength and resist heat treatment. Therefore, they will not break easily as do bronze or steel springs.

NO SPRING IN THE WORLD IS BETTER THAN HOROLOVAR FOR YOUR CLOCK SUSPENSION

Popular Wire Assortment

Contains 12 Sizes:

Qty.	Inches	MM	Qty.	Inches	MM
1	.002	.051	2	.0032	.081
2	.0023	.058	2	.0035	.089
1	.0025	.064	1	.0037	.094
1	.003	.076	2	.004	.102

Item No. **SPWA-101** **\$19.00** pk.

Intermediate Wire Assortment

Contains 12 Sizes:

Inches	MM	Inches	MM	Inches	MM
.0019	.048	.0028	.071	.0038	.097
.0021	.053	.0031	.079	.0045	.114
.0022	.056	.0033	.084	.005	.127
.0024	.061	.0036	.091	.0055	.140

Item No. **SPWA-102** **\$19.00** pk.

May mix styles & sizes for each product to receive quantity discounts.

9pc. American Verge Assortment

Popular sizes for Ansonia, Seth Thomas, Seikosha, Waterbury, etc. Individually wrapped in a convenient plastic storage case.

Item No. **PV-09**
\$11.00



400-Day Leveling Feet

3/8" Threaded shaft. Protective nylon leg.

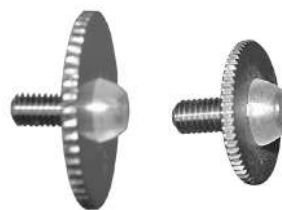

5/8" Dia. Item No. **P-20**
1" Dia. Item No. **P-21**

\$1.75 ea.

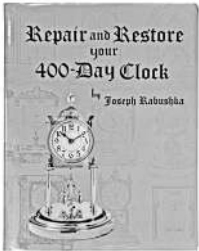

New Repair & Restore your 400-Day Clock

By Joseph Rebushka

This book provides a detailed analysis of each part of the 400-day clock. The author has over 30 years experience in repair and goes into how it works, why it works, and how to determine when it's faulty. Fully-illustrated step-by-step instructions describe in simple terms how to repair any part of the 400-day clock. There are two chapters devoted to the suspension spring alone. Complete with many pictures and figures. 88 Pgs. 7x10"

Item No. **BK-119** Hard Cover **\$19.95**



New Adjusting 400-Day Anniversary Clocks

By William J. Bilger

This pamphlet covers five areas that need to be checked in order to properly adjust the 400-Day clock. The topics are proper mechanical operation, proper escapement action, the beat, regulation or timing, and suspension spring: proper length, wire strength, and position of the fork. This booklet is designed to be paired with Horolovar 400-Day Clock Repair Guide, Item # **BK-118** (see below). Includes some drawings and pictures. 39 pages. 5-1/2" x 8-1/2"

Item No. **BK-117** Soft Cover **\$6.99**

Nevr-Dull Wadding Polish



Removes rust and corrosion instantly. Excellent for silver, gold, brass, copper, pewter, steel, aluminum, and chromium. Leaves no deposits in cracks. 5 oz.

Item No. **CP-17** **\$7.50**



400-Day Torsion Beat Calibrator

Item No. **TL-09**
\$10.95

Permanently attaches quickly & easily to the suspension wire, giving precision beat control by allowing fork adjustments 1/1000 of an inch or less. Eliminates the trial & error inherent in saddle adjustment for final fine tuning. Precision beat calibration creating more power, energy efficiency, longer running times & flutter resistance regardless of all variables like suspension spring strength, mainspring torque, & pendulum weight. The Calibrator gives such accuracy that it becomes a diagnostic tool, ruling out the beat as the cause of the clock stopping. Cuts hours of adjustment time to minutes. Allows the clock to be moved without ruining the beat, thus curtailing customer returns. Fits into any 400-day clock (minor modification may be necessary in rare cases). Comes with easy to follow instructions & diagrams.

400-Day Beat Setting Tool

Takes the work out of setting beats. Extra long arm allows you to make micrometer adjustments.

Item No. **TL-10** **\$21.00**

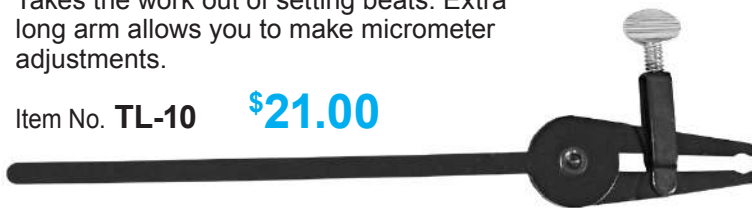

400-Day Battery Adapter

Save money! There's no more need to buy expensive battery packs. Just attach to the bottom of base & install 2 'AA' batteries (not included). Replaces battery #8 & #9 for Kundo, Junghans, etc. All metal construction in a compact 3-1/4"W x 4-3/8"H x 3/4"D.

Item No. **TL-144** **\$19.50**

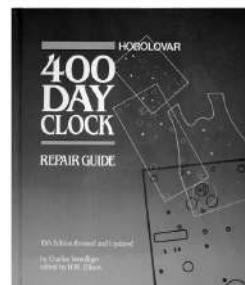

Horolovar 400-Day Clock Repair Guide

By Charles Terwilliger

A must for the collector & repairman. Chapters include: History, -US. Events. Striking, Patents, Pre-WW I; Problems w/Temperature & Timekeeping; Escapement adjustment; Questions & Answers; Myths & Facts; names & trademarks on dials; Pendulums, ratchet wheels, suspension brackets & saddles; Spare parts & repairs; 100's of photos of 400-Day Clocks. 106 Pgs. of Backplate illustrations. 12 Pgs. of susp. spring illustrations & info. Over 100 examples of Pendulums, Ratchet Wheels, & Susp. Brackets & saddles. Complete Listing of Horolovar Replacement parts & tools. Photos/Parts List of common Kundo, Koma, Kern & Schatz clocks. Tables & close-up diagrams for repair. Plus more. 237 Pgs. Oversized. 10th Edition. 9x10"

Item No. **BK-118** Hard Cover **\$29.75**

Chime Rods, Gongs, Bells & Accessories



Hermle Westminster Chime Assembly

For Grandfather clocks. 8 rod, longest rod 26". Cast iron bracket. Press in rods.

Item No. **CHR-51** **\$59.95**

Hermle Triple Chime Assembly

For Grandfather clocks. Slanted configuration. 12 rod, longest rod 26". Cast iron bracket. Press in rods.

Item No. **CHR-61** **\$64.95**

Hermle Mantle Chime Rods

For bottom mount movements.
Cast iron bracket.
Westminster: 5 rods
Triple: 8 rods

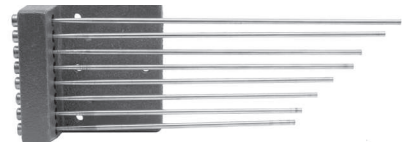

Item No.	Chime	Longest Rod	Price
CHR-16	Westmin.	6-3/4"	\$22.95
CHR-17	Triple	6-3/4"	\$28.95

Striking Hammers

Brass, nylon head, with set screw.
Measurement includes head.



1/2"L Item No. **CHH-12**

5/8"L Item No. **CHH-58** **\$1.50** ea. **\$12.00** dz.

3/4"L Item No. **CHH-34** *May mix sizes to receive quantity discounts.*

Brass Clock Bells



Dia.	Item No.	Price	Dia.	Item No.	Price
1"	CHB-1	\$5.00	3-1/2"	CHB-312	\$16.95
1-1/4"	CHB-114	\$5.25	3-3/4"	CHB-334	\$16.95
1-1/2"	CHB-112	\$5.50	4"	CHB-4	\$21.50
1-3/4"	CHB-134	\$5.75	4-1/2"	CHB-412	\$24.50
2"	CHB-2	\$6.50	5"	CHB-5	\$29.50
2-1/4"	CHB-214	\$7.25	5" Steel	CHB-5S	\$14.95
2-1/2"	CHB-212	\$8.50	5-3/4"	CHB-534	\$31.50
3"	CHB-3	\$10.95			

Bim Bam Mantle Chime Rod

3 rods. For bottom mount movements.
Longest rod 5-1/4".
Cast iron bracket.



Item No. **CHR-10** **\$13.95**

English Coil Gongs

Flat: 3" dia. Brass block.
Round: 3-1/2" dia.



Item No.	Rod Style	Price
CHG-3F	Flat	\$3.95
CHG-3R	Round	\$2.50

Round Coil Gong

4-3/8" dia. Round wire.

Item No. **CHG-434** **\$2.95**

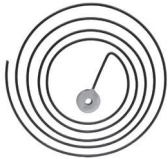

Gongs with Base

For mounting on side wall of clock case. Cast iron base.



Item No.	Gong Dia.	Price
CHG-4B	4-1/4"	\$9.95
CHG-5B	5-1/4"	\$14.95

Metal Gong Base

Attractive petal design. Attaches directly to the back of the case and holds the gong in position by a center screw.
2"W x 2-1/2"L x 3/4"D.



Item No. **CHG-1** **\$3.50**

Chime Hammer

Brass, for kitchen, Tambour & other mantle clocks. 5-1/2" brass arm that can be cut to your desired length. 1/2" brass striker.

Item No. **CHH-40** **\$3.25**

French Bell Hammer

Solid brass. 5/8" long nylon headed hammer with adjusting screw. Square hole sleeve mounting nut. 2-3/4" Long.



Item No. **CHH-41** **\$3.25**

French Bell Hammer

Solid brass, 1/2" dia. disc hammer. Square hole sleeve mounting nut. 2-1/2" L



Item No. **CHH-42**
\$3.00

French Bell Stand

With nut. Solid brass.
2-3/16" L

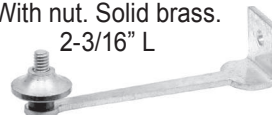

Item No. **CHB-26** **\$4.50**

Mounting Nut

Sold separately.



Item No. **CHB-7** **\$1.50**

Hermle & Kieninger Parts

Hermle Balance Units

For currently manufactured Hermle movements or interchangeable replacements for old styles.

\$51.50 ea.

For use with #130 and #140 series movements.
Item No. **PHB-130**



For use with 340, 350 & 1050 series movements.
Item No. **PHB-300**

Hermle Platform Escapement

For the #132-071 Ship's Bell movement. 1-3/8" x 13/16". Ruby jewels.

Item No. **PE-132** **\$160.00**

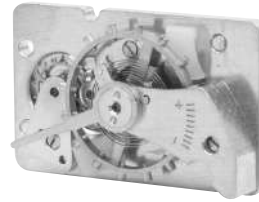

Kieninger Platform Escapement

For J Series movement. 13/16" x 1-1/4"

5 Jewels - Item No. **PE-065** **\$85.00**

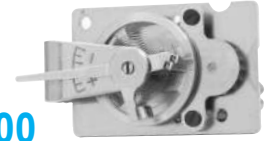

Clicksprings

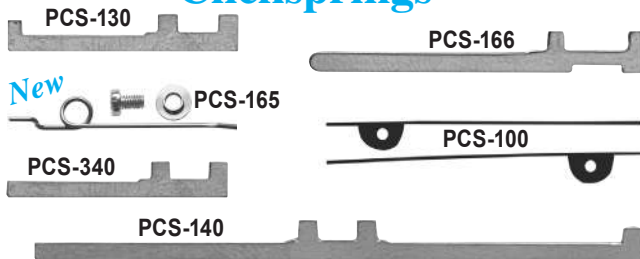

Mfg.	Movement / Series	Length	Item No.	1	6+
Generic	Set - 3 Left, 3 Right	1-7/8"	PCS-100	\$4.95	-----
Hermle	#A-439/130, 131, 132, 771	29/32"	PCS-130	\$1.00	90¢
Hermle	#A-440/140, 141, 150, 151	2-7/16"	PCS-140	\$1.00	90¢
Kieninger	RW, RWJ, RWS & others	1-3/4"	PCS-165	\$3.50	\$3.25
Kieninger	Generic	1-5/16"	PCS-166	\$1.65	\$1.55
Hermle	#A-473/340, 341, 350, 351, 791, 1050	1-1/16"	PCS-340	\$1.00	90¢

Ratchet Wheels

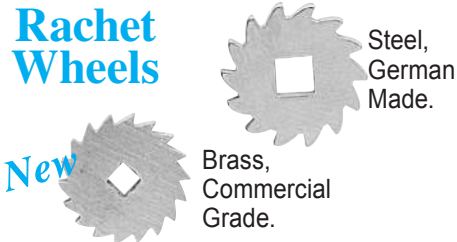

Movement / Series	Item No.	1	6+
#A-380/130, 131, 132	PRW-130	\$2.00	\$1.75
#A-314/141, 150, 151, 340, 341, 350, 351, 1050	PRW-140	\$2.00	\$1.75
Diameter / Teeth	Item No.	1	6
15mm - 18 teeth	PRW-150	\$2.50	----
16mm - 18 teeth	PRW-160	\$2.50	----
17mm - 20 teeth	PRW-170	\$2.50	----



Clicks
For Hermle ratchet #A-2.
Item No. **PHCL-100**
\$1.75 ea.

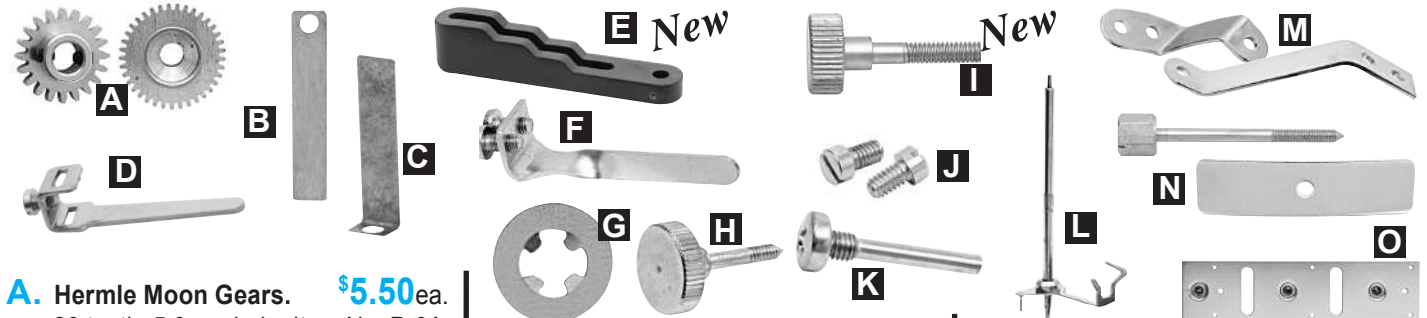

- A. Hermle Moon Gears.** **\$5.50** ea.
20 teeth, 5.0mm hole Item No. **P-01**
30 teeth, 5.0mm hole Item No. **P-02**
- B. Kieninger Flat Leaf Spring.** **85¢**
For strike hammers Item No. **P-03**
- C. Kieninger Lift Springs.** **85¢**
For strike hammers. Mvmts: KKU, KS, KSU, RK, RSU, RU, RW, RWS, RWU Item No. **P-04**
- D. Hermle Chime Levers.** Small for wall, mantle and G.M. Large for G.F.
Small Item No. **P-05** **\$1.50**
Large Item No. **P-06** **\$2.00**
- E. Kieninger Chime Selector Switch.** **\$3.50**
Plastic switch for KSU mvmts.
1-3/4" long Item No. **P-06K**

- F. Kieninger Chime Lever.** **\$2.00**
For G.M. & G.F. mvts. Item No. **P-07**
- G. Kieninger Tension Safety Clip.** **\$1.50**
For winding arbor. 6 pcs. Item No. **P-08**
- H. Hermle Susp. Spring Screw.** **\$2.00**
M1.4 x 9.5mm. Also works on other clocks.
Item No. **P-09**
- I. Kieninger Susp. Spring Screw.** **\$1.50**
Item No. **P-22**
- J. Kieninger Machine Screws.** **\$3.95**
Used on many places on many mvmts.
12 pcs. all one size. Item No. **P-10**
- K. Kieninger Setting Screw.** **\$2.00**
Item No. **P-11**

- L. Hermle Pallet Forks.**
Mvmts. #340-020 #**P-12** **\$7.95**
Mvmts. #350 & 1050 #**P-13** **\$7.95**
- M. Hermle Mounting Feet.**
Small Item No. **P-14** **\$3.00** set
Large Item No. **P-15** **\$4.00** set
- N. Hermle Mounting Plate & Screw.**
1-1/2"L screw. 22mm threaded shaft.
5/8" x 1" plate.
Screw Item No. **P-17** **\$1.50**
Plate Item No. **P-18** **\$1.50**
- O. Kieninger Mounting Plate.** **\$4.95**
For Grandfathers, 6 hole spread.
Item No. **P-19**

All prices are subject to change without notice.

Urgos & Hermel Parts



Urgos Escape Wheels

Factory original, self correcting, unmounted. For grand-mother, grandfather and some wall clocks.

\$21.95ea.

Fits Movement	Item Number
UW-03 Series	HP-64
UW-32/66 Series	HP-65

Hermle Parts "New" Older Inventory



Verge

Auto beat with pin type crutch post.
For 451 series.

Item No. **HP-01** **\$9.95**

Verge Bridge

Post Length 2-5/8" (68mm).
For 451 and 1151 series.

Item No. **HP-10** **\$4.95**



Verge Bridge Plate - Old Style

Mounting hole distance 7/8" (25mm) for 451, 461,
1151, 1161 series.

Item No. **HP-15** **\$4.95**



Pillar Post

Threaded Ends 1-13/16" long.

For upper plate. Item No. **HP-30**
For lower plate with threaded mounting
bolt hole. Item No. **HP-31**

\$3.00ea.



Plate Hex Nuts

4 piece set. 6.3mm dia. 3.3mm inside diameter.

Item No. **HP-32** **\$2.00** set



Lock Washer & Screw

6 washers & 6 screw set.

Item No. **HP-50** **\$3.95** set



Cam

For strike & chime movements.

Item No. **HP-40** **\$4.95**

Chime Release Lever



New Style. For all chime movements.
Tension spring no longer needed.

Item No. **HP-44** **\$4.95**

Hammer Lifter

For Westminster &
Triple Chime movements.

Item No. **HP-42** **\$4.95**



Escape Wheels

For auto beat movements.

For 85cm pendulum. Item No. **HP-20**

For 43,45,48,55,94cm pendulums.

Item No. **HP-21**

For 52,66,75,114cm pendulums Item No. **HP-22**

\$8.95ea.



Chain Gear

For 451 and 1151 series. Strike Side.

Item No. **HP-55** **\$12.95**



Strike Gathering Pallet

For all chime movements.

Item No. **HP-45** **\$6.00**



Hour Wheel & Pipe

For 451 Series.

11/16" Pipe Item No. **HP-48** **\$4.95**

2" Pipe Item No. **HP-49**



Pendulum Spring Guard

With Screw.

Item No. **HP-43** **\$4.95**

Clicks, Wires & Hairsprings

Clicks & Rivets Assortment



50 pieces, brass clicks & steel rivets.

Item No. **HW-57** **\$9.95**

Bergeon Click Spring Wires

Steel. 100 pc. assort. for watches & very small clocks. Largest wire is .005" thick by .0095" wide. 1-3/8"L.

Item No. **PW-41** **\$11.95**

New American Click Assortment



18 pieces.
9 types, 2 of ea.
Item No. **PW-01**
\$6.95

12pc. Click Wires

Steel, 6 - 4-1/8"L wires, 5 - 5"L wires.

Item No. **PW-40** **\$1.50**pk.

Clickes & Rivets with Wires

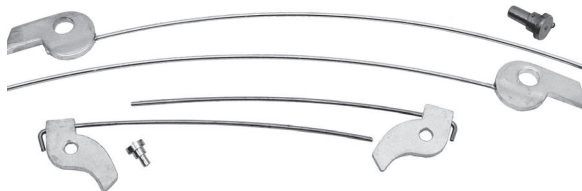

Includes: 3 right & 3 left clicks & 6 rivets. Brass clicks & wires, steel rivets.

Click Size	Item No.	Price
1/2"	PW-10	\$3.00
3/4"	PW-11	\$3.50

Wire Assortments

Brass Wire 23 pc. assort. 6" lengths. Gauge sizes from 8-22. Item No. **PW-50** **\$5.95**

Blue Steel Staff & Pivot Wire 28 pc. assort. 4" lengths. Gauge sizes from .55mm to 3.25mm. Item No. **PW-51** **\$6.50**

Steel Staff & Pivot Wire 37 pc. assort. 6" lengths. Gauge sizes from 8-22. Item No. **PW-52** **\$6.95**

Clicks, Formed Springs & Rivets

Includes: 2 brass clicks, 2 springs, 2 rivets. Can be used on other movements.

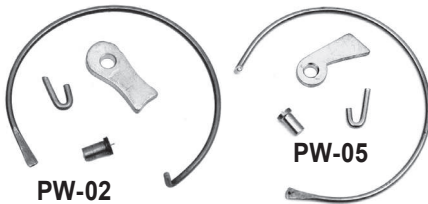

Type	Item No.
Ansonia	PW-02
Gilbert	PW-03
Ingraham	PW-04
New Haven	PW-05
Sessions	PW-06
S. Thomas (New)	PW-07
S. Thomas (Old)	PW-08
Waterbury	PW-09

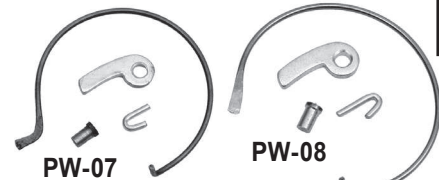

\$3.50pk.

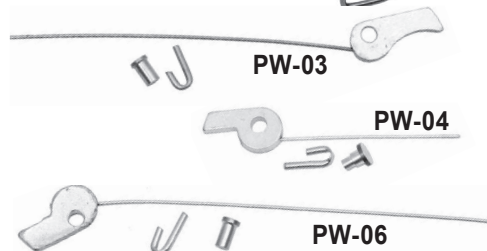

Brass Spring Wire

1 oz. spools. B & S sizes.

Gauge	Dia.	Item No.	Price
#26	.0165" / .42mm	PW-44	\$9.05
#24	.0201" / .53mm	PW-45	\$7.25
#22	.0253" / .65mm	PW-46	\$7.25



New Steel Pallet Jewels

Assorted sizes for outside escapements. Sold by the pair or assort. dz.

Size	Item No.	Size	Item No.	Price
1.9mm	PW-13	2.25mm	PW-16	\$6.00 pr.
2.00mm	PW-14	2.40mm	PW-17	
2.15mm	PW-15	2.50mm	PW-18	

Assortment - 6 pr. (1 pr. each size)
Item No. **PW-19** **\$28.00**



Description	Item No.	Price
12pc. assort, 2pc. ea. sz.	PW-20	\$29.95
5pc., 2.00mm hub dia.	PW-21	\$12.50
5pc., 2.50mm hub dia.	PW-22	\$12.50
5pc., 3.00mm hub dia.	PW-23	\$12.50
5pc., 3.20mm hub dia.	PW-24	\$12.50
5pc., 4.50mm hub dia.	PW-25	\$12.50
5pc., 5.00mm hub dia.	PW-26	\$12.50

Pivots

Easy replacements for broken pivots

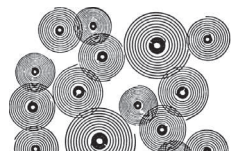

Hairsprings

72 Pc. Assortment

Have the right size on hand when you need it. Great for table clocks, alarm clocks, lever escapements & more! With collets. Includes a clear plastic storage box.

Item No. **PW-60** **\$15.95**

Specialty Parts & Hardware Assortment Kits

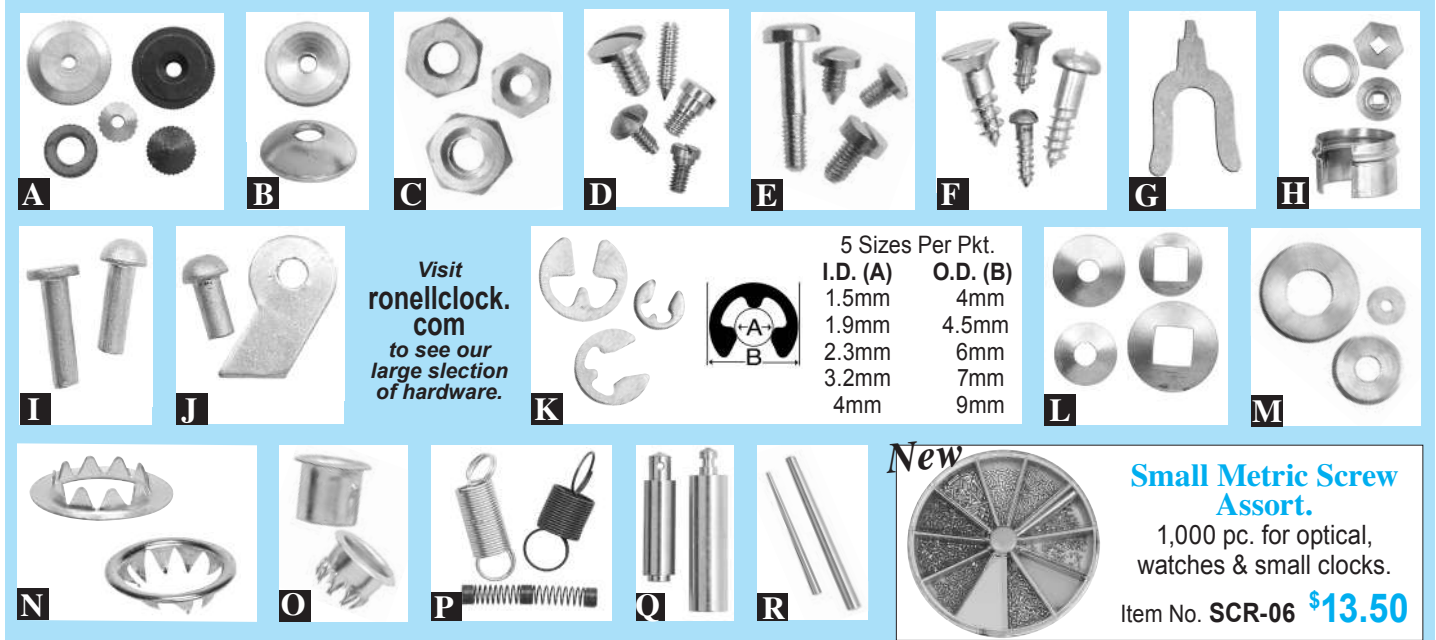

- A. Metric Hand Nut Assort.** For wall, mantle, grandfather & grandmother clocks. 24pcs. Item No.# HW-50 **\$12.50**
- Hermle Hand Nut Assort.** Fits Hermle, Jauch & Kieninger. For wall, mantle, shipsbell, GM & GF mvmts. 12pcs. - 4ea. small, med., large. 2 hole sizes. Will not fit Urgos. Item No. # HW-49 **\$4.95**
- B. Amer. Hand Nut Assort.** 12pcs. # HW-51 **\$4.95**
- C. Hex Nut Assort.** 100 pcs.
Brass Item No. HW-52 **\$4.75**ea.
Nickel Item No. HW-53
- D. Bergeon Alarm Screw Assort.** Brass & steel. 100 pcs. Item No. SCR-01 **\$12.95**
- E. Metric Screw Assort.** Small size 100 pcs.
Brass Item No. SCR-03 **\$6.50**ea.
Nickel Item No. SCR-04
- F. Miniature Wood Screw Assort.** Sizes 0, 2, 3, 4, 1/4" & 3/8" long. Flat & round head. Slotted & Phillips. 50 pcs. Item No. SCR-10 **\$5.50**
- Wood Case Screw Assort.** Nickel & brass, flat head, 1/2" to 11/16" long. 100 pcs. Item No. SCR-05 **\$5.50**
- G. Count Wheel Washers.** Brass. 10 pieces. Item No. HW-54 **\$3.95**
- H. Hand Bushings** for European & American Hr. & Min. 24 pcs. Item No. HW-55 **\$9.95**
- I. Rivet Assort.** Brass. 100 pcs. Item # HW-56 **\$5.95**
- J. Clicks & Rivets Asst.** Brass. 50 pc. #HW-57 **\$9.95**
- K. Split Tension Washer Assort.** German clocks. Stainless Steel
50 pcs - Item No. HW-60-5 **\$4.95**
100 pcs - Item No. HW-60-1 **\$8.95**
- L. Hand Washers.** Convex brass, . 100 pcs.
Round Item No. HW-63 **\$5.50**ea.
Square Item No. HW-64
Combination Item No. HW-65
Cuckoo & French. 8.25mm OD, 2.4mm ID, 12 pcs. Item No. CC-814 **\$2.50**ea.
- M. Clock Washer Assort.** Flat. 100 pcs.
Brass Item No. HW-66 **\$5.00**ea.
Steel Item No. HW-67
Cuckoo 6.4mm OD, 2.54mm ID, 12 pcs. Item No. CC-813 **\$2.50**ea.
- N. Dial Grommets.** Brass.
11/16" dia. (1/2" I.D.) 10 pcs. #HW-68 **\$3.50**
1/2" dia. (3/8" I.D.) #HW-69 **15¢**ea. 10+ **12¢**ea.
- O. German Grommet Assort.** 15 pcs. (3ea of 5 styles) Item No. HW-70 **\$7.95**
- P. Clock Spring Assort.** 24 pcs.
German Mvmts. Item No. PCS-36 **\$10.95**ea.
Cuckoo Mvmts. Item No. PCS-37
- Q. Dial Mounting Feet.** Set of 4.
Size: Length/Dia. 45mm x 8mm.....#HW-72 **\$7.50**ea.
28mm x 6mm.....#HW-73 20mm x 5mm.....#HW-74
- R. Taper Pins - German Made**
- | Size | | 50 Pcs | 100 Pcs | |
|------------------|-------|----------|----------|-------------------|
| .011 x .050 x 1" | Brass | HTP-115B | HTP-111B | |
| .011 x .050 x 1" | Steel | HTP-115S | HTP-111S | 50 pc. pk. |
| .027 x .070 x 1" | Brass | HTP-275B | HTP-271B | \$4.50 ea. |
| .027 x .070 x 1" | Steel | HTP-275S | HTP-271S | |
| .029 x .065 x 1" | Brass | HTP-295B | HTP-291B | |
| .029 x .065 x 1" | Steel | HTP-295S | HTP-291S | 100 pc. pk |
| .044 x .075 x 1" | Brass | HTP-445B | HTP-441B | \$7.95 ea. |
| .044 x .075 x 1" | Steel | HTP-445S | HTP-441S | |
| .070 x .102 x 1" | Brass | HTP-705B | HTP-701B | |
| .070 x .102 x 1" | Steel | HTP-705S | HTP-701S | |
- 140pc. Assortment** Brass Item No. HTP-140B **\$12.95**ea.
Steel Item No. HTP-140S

Brass Wood Screws

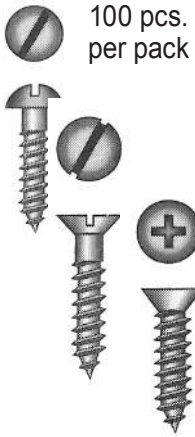

100 pcs. per pack

Style	No.	Length	Item No.	Price
Flat Head Phillips	2	3/8"	SCR1-100	\$6.95
	3	3/8"	SCR1-101	\$8.95
	4	3/8"	SCR1-102	\$7.95
Flat Head Slotted	0	1/4"	SCR1-200	\$7.95
	2	1/4"	SCR1-201	\$6.95
	3	1/4"	SCR1-202	\$6.95
	3	3/8"	SCR1-203	\$7.95
	4	1/4"	SCR1-204	\$4.95
	4	3/8"	SCR1-205	\$5.95
Round Head Slotted	2	1/4"	SCR1-301	\$6.95
	2	3/8"	SCR1-302	\$6.95
	3	3/8"	SCR1-303	\$6.95

Watch Spring Bar Assortment

100 pcs. in sizes 5/16" (8mm), 3/8" (10mm), 7/16" (12mm), 1/2" (13mm), 5/8" (16mm), 11/16" (18mm), 3/4" (19mm). Complete with 7 compartment plastic box with see-through sliding lid.

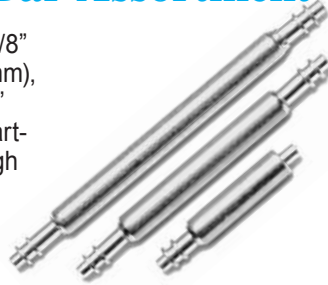

Item No. HW-76 **\$5.75**

450 pc. Spring Bar Assortment

Includes: 8 to 24mm spring bars. 25 of each size. Sorted in a convenient, partitioned box. Stainless steel, double flange spring bars. 1.3mm thickness.



Item No. HW-78 **\$14.95**

Glow-In-The-Dark Paint Kit

New

Set includes:

- 1 Bottle of varnish
- 1 Bottle of paint thinner
- 1 Bottle of green glow-in-the-dark powder
- 1 plastic mixing dish
- 1 Applicator



Item No. CP-18 **\$18.95**

Order On-Line... Visit Our Website:
ronellclock.com

Repair Envelopes

Great for jewelry & watches. White paper with blue printing & gummed closing flap. Place for name, address, instructions, phone no. & charges. Space at bottom for stamping store name.

3-1/8"W x 5-1/2"H. Box of 500.

Item No. RT-01 **\$29.95**

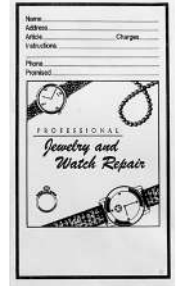

Claim Check Tags

Heavy white stock paper with string tie & numbered tear-off claim check. Place for name, date, promised date & charges. Box of 1000. 3"W x 2-1/2" H. Numbered.

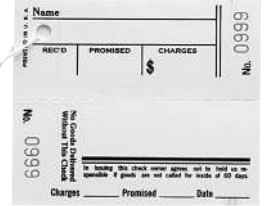

#1 - 1,000 Item No. RT-02

#1,001 - 2,000 Item No. RT-03

\$51.95ea.

New Repair Envelopes

Triple duty repair envelopes. Each numbered envelope has 2 detachable stubs; one for the customer claim check and one for your file. Place for received & promised dates, name, address, ph. #, remarks, article, signature, repaired by, payment method, charges, tax, deposit. Back of envelope also has convenient Layaway Payments ledger & comments area. Envelope measures 3-1/8" x 5-3/4". 1,000 per carton in numbered series.

#1 - 1,000 Item No. RT-06

#1,001 - 2,000 Item No. RT-07

\$51.50ea.



Reclosable Zip-Lock 2 Mil. Poly Bags

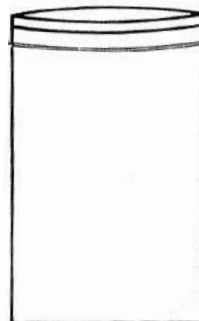

Size	Item No.	100 pc.
1-1/2" x 1-1/2"	ZBG-15	\$1.50
2" x 2"	ZBG-22	\$1.75
2" x 3"	ZBG-23	\$2.00
3" x 4"	ZBG-34	\$2.50
3" x 5"	ZBG-35	\$2.50
5" x 7"	ZBG-57	\$3.75
6" x 9"	ZBG-69	\$4.95
8" x 10"	ZBG-810	\$7.50

Storage Containers

Made from sturdy metal and durable heavy plastic for use over and over. Great for work, garage, home or where ever.

Metal Storage Containers

Aluminum, See-Through Lids



7/8" dia. x 3/4" H

Item No. **BXA-1**

35¢ ea. Box of 24 **\$7.20**



1-3/8" dia. x 5/8" H

Item No. **BXA-2**

45¢ ea. Box of 12 **\$4.80**



1-5/8" dia. x 5/8" H

Item No. **BXA-3**

50¢ ea. Box of 12 **\$5.40**



2" dia. x 7/8" H

Item No. **BXA-4**

70¢ ea. Box of 12 **\$7.80**

Aluminum Storage Box with 20 Aluminum Containers



Storage Box Size

6-1/2"W x 5-1/4"L x 3/4" D

See-Thru Lid Container Size

1-1/8" dia. x 5/8"H

Item No. **BXA-20A** **\$7.95** ea.

Plastic Storage Containers

With See-Through Lids

1"W x 1"L x 5/16" D

Stackable. Item No. **BXP-1**

12 pc. Pk. **\$3.75**



1³/₈"L x 1⁷/₈"W x 1¹/₁₆" D

Stackable. Item No. **BXP-2**

40¢ ea. Box of 12 **\$4.20**



1-1/8" dia. x 3/4"D, 6 pcs.

Item No. **BXP-7** **\$3.00**

2-3/4" dia. x 1"D, 4 pcs.

Item No. **BXP-3** **\$3.00**



8 Compartments

3-1/8"L x 2"W x 1/2"D

Compartment size 11/16" x 7/8"

Item No. **BXP-4**

\$1.50



12 Compartments

Great for Bushings!

3-1/4"L x 2"W x 5/8"D

Compartment size 1/2" x 7/8"

Item No. **BXP-8**

\$2.00



18 Compartments

7-5/8"L x 3-3/4"W x 7/8"D

Compartment size 1-1/8" sq.

Item No. **BXP-5**

\$4.95



24 Compartments

7-3/8"L x 4-5/8"W x 7/8"D

Compartment size 1-1/8" sq.

Item No. **BXP-6**

\$5.95



Plastic Revolving Lid Containers

Great for bushings. No-spill access. Two sizes to choose from.



11 Compartments

3-1/2" Dia., 3/8" deep.

Item No. **BXP-11**

\$3.25



22 Compartments

7-1/2" Dia., 5/8" deep.

Item No. **BXP-12**

\$5.25

2 Tier Storage Tray with Cover

Keep dust off your delicate small parts. Two 3-5/8" dia.

stackable trays - one

plain and one partitioned.

See-through plastic lid.

Item No. **BXP-10**

\$4.50



Clock Keys & Cranks

American Brass Single End



\$2.25
12+ **\$1.85**ea.

No.	Size MM	Item No.
#000	2.0	KAS-000
#00	2.2	KAS-00
#0	2.4	KAS-0
#1	2.6	KAS-01
#2	2.8	KAS-02
#3	3.0	KAS-03
#4	3.2	KAS-04
#5	3.4	KAS-05
#6	3.6	KAS-06
#7	3.8	KAS-07
#8	4.0	KAS-08
#9	4.2	KAS-09
#10	4.4	KAS-10
#11	4.6	KAS-11
#12	4.8	KAS-12

Long Shaft, Brass American



\$2.50
12+ **\$2.25**ea.

1-3/8" Shaft, for Fashion, Calendar & Anniversary clocks

No.	Size MM	Item No.
#3	3.0	KLS-03
#4	3.2	KLS-04
#6	3.6	KLS-06
#8	4.0	KLS-08
#11	4.6	KLS-11

Extra Long Shaft



1-13/16" Shaft. American size #3 (3.0mm). Brass. For Schatz lantern clocks.

Item No. **KELS-03** **\$2.75** 3+ **\$2.50**ea.



Brass Single End Assortment

American sizes. 15 keys on a metal ring. Sizes #000 to #12

Item No. **KRS-018** **\$33.00**

Large Wing, Brass American



For easier winding

\$2.75
12+ **\$2.25**ea.

No.	Size MM	Item No.
#6	3.6	KLW-06
#7	3.8	KLW-07
#8	4.0	KLW-08
#10	4.4	KLW-10
#12	4.8	KLW-12
#13	5.0	KLW-13
#14	5.2	KLW-14
#16	5.5	KLW-16

American Brass Double End



New

\$2.50 12+ **\$2.00**ea.

No.	Size MM	Item No.
#4/1	3.2/0	KAD-41
#4/3	3.2/000	KAD-43
#4/5	3.2/00000	KAD-45
#5/1	3.4/0	KAD-51
#5/3	3.4/000	KAD-53
#5/5	3.4/00000	KAD-55
#6/1	3.6/0	KAD-61
#6/3	3.6/000	KAD-63
#6/4	3.6/0000	KAD-64
#6/5	3.6/00000	KAD-65
#7/1	3.8/0	KAD-71
#7/3	3.8/000	KAD-73
#7/5	3.8/00000	KAD-75
#8/1	4.0/0	KAD-81
#8/3	4.0/000	KAD-83
#8/5	4.0/00000	KAD-85

Trademark Single End

American sizes. Brass



\$2.75 12+ **\$2.25**ea.

Company	No.	Size MM	Item No.
Ansonia	#6	3.6	KTS-01
Chelsea	#3	3.0	KTS-02
Chelsea	#5	3.4	KTS-03
Chelsea Mini	#000	2.0	KTS-04
Gilbert	#6	3.6	KTS-05
Ingraham	#6	3.6	KTS-06
Kroeber	#6	3.6	KTS-07
Ithaca	#7	3.8	KTS-08
New Haven	#6	3.6	KTS-09
Sessions	#6	3.6	KTS-10
Schatz	#3	3.0	KTS-14
S. Thomas	#6	3.6	KTS-11
Waterbury	#6	3.6	KTS-12
Welch	#7	3.8	KTS-13



Brass Double End Assortment

15 keys on a metal ring. Sizes #4/1 to #8/5

Item No. **KRD-15** **\$29.50**

Schatz Long Shaft Trademark Key



\$3.25

No.	Size MM	Item No.
#3	3.00	KTS-14

Trademark Double End

American sizes. Brass



\$3.75 12+ **\$3.25**ea.

Company	No.	Size MM	Item No.
Ansonia	#6/4	3.6/0000	KTD-01
Gilbert	#6/4	3.6/0000	KTD-02
Ingraham	#6/3	3.6/000	KTD-03
New Haven	#6/3	3.6/000	KTD-04
Sessions	#6/4	3.6/0000	KTD-05
S. Thomas	#4/4	3.2/0000	KTD-06
S. Thomas	#6/4	3.6/0000	KTD-07
Waterbury	#6/4	3.6/0000	KTD-10
En. Welch	#7/3	3.8/000	KTD-11

Seth Thomas Double End

\$4.75ea.

No.	Size (MM)	Item No.
#9/4	4.2/0000	KTD-08
#13/4	5.0/0000	KTD-09

Old Style Tall Clock Crank

Black steel handle with a brass shank. American made.



\$14.95 3+ **\$14.00** ea.

No.	Item No.
#10	KOC-10
#12	KOC-12
#14	KOC-14
#16	KOC-16

Vienna & OG Crank



American Made

\$2.00 12+ **\$1.85** ea.

No.	Size MM	Item No.
#000	2.0	KVC-000
#00	2.2	KVC-00
#0	2.4	KVC-0
#1	2.6	KVC-1
#2	2.8	KVC-2
#3	3.0	KVC-3
#4	3.2	KVC-4
#5	3.4	KVC-5
#6	3.6	KVC-6
#7	3.8	KVC-7
#8	4.0	KVC-8

Grandfather Crank



American Made

\$14.25 6+ **\$13.75** ea.

No.	Size MM	Item No.
#8	4.0	KGC -08
#9	4.2	KGC -09
#10	4.4	KGC -10
#11	4.6	KGC -11
#12	4.8	KGC -12
#13	5.0	KGC -13
#14	5.2	KGC -14
#16	5.6	KGC -16
#18	6.0	KGC -18
#20	6.4	KGC -20
#22	6.8	KGC -22

Fancy Grandfather Crank



Swiss Sizes

No.	Size MM	Item No.
#7	4.00	KHG-407
#8	4.25	KHG-408

\$8.50 6+ **\$8.00** ea.

New German Clock Crank



New "older" inventory. Swiss size #7 (4.00mm).
Some tarnish on brass.

Item No. **KHG-410**

\$8.95 3+ **\$8.50** ea.

New Kieninger Clock Crank



2-3/16" extra long shaft. New "older" inventory.
Swiss size #7 (4.00mm). Some tarnish on brass.

Item No. **KHG-411**

\$14.95 3+ **\$14.50** ea.

New Brass Chronometer Keys



Non-Ratcheting #4 (3.2mm)
Item No. **KCH-1**

\$12.00



Ratcheting English
(winds counter-clockwise) #4 (3.2mm)
Item No. **KCH-2**

\$23.75



Ratcheting Hamilton
(winds counterclockwise) #4 (3.2mm)
Item No. **KCH-3**

\$25.50

4-Prong Clock Key



American
Made

Sizes	Item No.
5, 7, 9, 11	K4P-511
6, 8, 10, 12	K4P-612

\$7.50 3+ **\$7.25** ea.

5-Prong Clock Key



American
Made

Sizes	Item No.
3, 5, 7, 9, 11	K5P-311
4, 6, 8, 10, 12	K5P-412

\$9.75 3+ **\$9.50** ea.

Clock Key Gauge

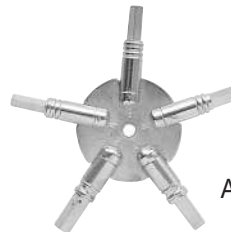

American
Made

Sizes	Item No.
3, 5, 7, 9, 11	KG-311
4, 6, 8, 10, 12	KG-412

\$11.00 2+ **\$10.00** ea.

Let-Down Keys

American Made.

4 pc. Set

Handle with 3 Chucks.
Sizes 5/6, 7/8, 10/12

Item No. **KLD-04** **\$33.75**

7 pc. Set

Handle with 6 Chucks.
Sizes 1/2, 3/4, 5/6, 7/8,
10/12 & 14/16

Item No. **KLD-07** **\$48.75**



Alarm
Chuck

No.	Item No.
#0/00	KLDC-000
#1/2	KLDC-12
#3/4	KLDC-34
#5/6	KLDC-56
#7/8	KLDC-78
#9/11	KLDC-911
#10/12	KLDC-1012
#14/16	KLDC-1416

Individual Chucks

\$7.00

3+
\$6.50 ea.

Alarm Chuck

Item No. **KLDC-5**
\$8.95

Plastic Handle

Item No. **KLDH-1**
\$12.95

Steel Single End



Swiss Sizes

\$2.25 12+ \$1.85 ea.

50+ \$1.50 ea.

No.	Size MM	Item No.
#00	2.00	KIS-00
#0	2.25	KIS-0
#1	2.50	KIS-1
#2	2.75	KIS-2
#3	3.00	KIS-3
#4	3.25	KIS-4
#5	3.50	KIS-5
#6	3.75	KIS-6
#7	4.00	KIS-7
#8	4.25	KIS-8
#9	4.50	KIS-9
#10	4.75	KIS-10
#11	5.00	KIS-11
#12	5.25	KIS-12
#13	5.50	KIS-13
#14	5.75	KIS-14
#15	6.00	KIS-15

Vienna & OG Cranks



Swiss Sizes

\$2.00

12+ \$1.75 ea.

No.	Size MM	Item No.
#0	2.25	KIC-00
#1	2.50	KIC-01
#2	2.75	KIC-02
#3	3.00	KIC-03
#4	3.25	KIC-04
#5	3.50	KIC-05
#6	3.75	KIC-06
#7	4.00	KIC-07
#8	4.25	KIC-08
#9	4.50	KIC-09
#10	4.75	KIC-10
#11	5.00	KIC-11

Zappler Pendulett



Nickel,
Swiss Sizes

No.	Size MM	Item No.
#2	2.75	KPN-01

\$1.25 6+ \$1.00 ea.

5-Prong Brass

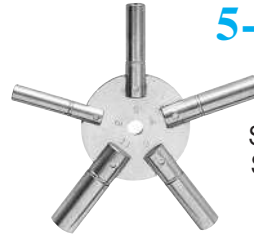

Swiss Sizes

Sizes	Item No.
2, 4, 6, 8, 10	KI5P-210
3, 5, 7, 9, 11	KI5P-311

\$6.50 3+ \$6.00 ea.

Keebler & Lux



American Sizes

No.	Size MM	Item No.
#1	2.6	KKL-1
#2	2.8	KKL-2
#3	3.0	KKL-3

\$1.50 6+ \$1.25 ea.

Morbier Style Grandfather Cranks

Nickled steel shafts with steel shanks and a wood handle



Swiss Sizes

\$6.95

3+ \$6.50 ea.

No.	Size MM	Item No.
#7	4.00	KMG-07
#8	4.25	KMG-08
#9	4.50	KMG-09
#10	4.75	KMG-10
#11	5.00	KMG-11
#12	5.25	KMG-12
#14	5.75	KMG-14
#16	6.25	KMG-16
#18	6.75	KMG-18

Steel Double End



Swiss Sizes

No.	Size MM	Item No.
#4/3	3.25/1.75	KID-43
#4/5	3.25/1.95	KID-45
#5/3	3.50/1.75	KID-53
#5/5	3.50/1.95	KID-55
#6/3	3.75/1.75	KID-63
#6/5	3.75/1.95	KID-65
#7/3	4.00/1.75	KID-73
#7/5	4.00/1.95	KID-75
#8/3	4.25/1.75	KID-83
#8/5	4.25/1.95	KID-85

\$2.00 12+ \$1.80 ea.

Modern German Wall & Mantle

Swiss Size. Steel. #7 (4.00mm)

Item No. KHW-07

\$3.50



Grandfather Crank



Swiss Sizes

No.	Size MM	Item No.
#10	4.75	KIG-10
#11	5.00	KIG-11
#12	5.25	KIG-12
#13	5.50	KIG-13
#14	5.75	KIG-14
#15	6.00	KIG-15
#16	6.25	KIG-16
#18	6.75	KIG-18

\$6.95 3+ \$6.50 ea.

Modern Shipsbell

Swiss Size. Steel. #3 (3.00mm)

Item No. KHS-03

\$3.50



5-Prong Steel Watch Keys



Swiss Sizes

Sizes	Item No.
2, 4, 6, 8, 10	K5PW-210
3, 5, 7, 9, 11	K5PW-311

\$4.75 2+ \$4.50 ea.

Seikosha Style Key

For 8-Day & 31-Day Clocks. #7 (4.00mm)

Item No.

KSS-31

\$2.00 12+ \$1.75 ea.





Brass Double End Key Assortment

New 33 pcs. - American Sizes

Keys and Key Ends
 Assemble your solid brass, double end keys as you need them!
 Each set includes 3 each of the following end wing keys: #4, #5, #6, #7, and #8 plus 3 each of these small end sizes: #0, #1, #2, #3, #4, #5.

Item No. **KA-33B** **\$28.95**

Time Clock Crank

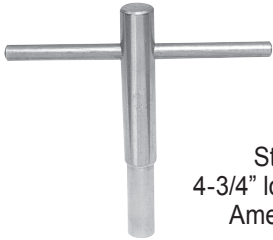

No.	Size MM	Item No.
#20	6.4	KTC-20
#23	7.0	KTC-23

Steel T-Bar,
 4-3/4" long brass shaft. **\$10.75**ea.
 American made.

Small Ends Replacements

Sold Individually

No.	Size MM	Item No.
#0	1.60	KE-0
#1	1.65	KE-1
#2	1.70	KE-2
#3	1.75	KE-3
#4	1.85	KE-4
#5	1.95	KE-5



\$1.00ea.. 12+ **85¢**ea.



Alarm Keys

Nickel plated for alarm and travel clocks. 100 piece assortment!

Item No. **KAA-01** **\$16.95**



Pocket Watch Keys

14 pc. set on key ring. Sizes 00-12.

Item No. **KWA-14** **\$10.95**

Key Gauge Plate

Swiss / Continental Sizes
 A must for finding & reordering the right key.

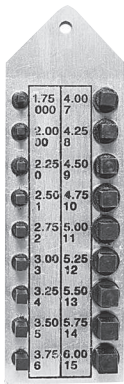

Item No. **KGP-018**

\$28.95ea.

18 Sizes:

#000 (1.75)
#00 (2.00)
#0 (2.25)
#1 (2.50)
#2 (2.75)
#3 (3.00)
#4 (3.25)
#5 (3.50)
#6 (3.75)
#7 (4.00)
#8 (4.25)
#9 (4.50)
#10 (4.75)
#11 (5.00)
#12 (5.25)
#13 (5.50)
#14 (5.75)
#15 (6.00)

Key Sizing Chart

Key No.	American Sizes	Swiss Sizes	Watch Sizes	Key No.	American Sizes	Swiss Sizes	Watch Sizes
#00000	1.6mm	1.25mm		#10	4.4mm	4.75mm	1.05mm
#0000	1.8mm	1.50mm		#11	4.6mm	5.00mm	1.00mm
#000	2.0mm	1.75mm		#12	4.8mm	5.25mm	.95mm
#00	2.2mm	2.00mm	2.00mm	#13	5.0mm	5.50mm	
#0	2.4mm	2.25mm	1.90mm	#14	5.2mm	5.75mm	
#1	2.6mm	2.50mm	1.80mm	#15	5.4mm	6.00mm	
#2	2.8mm	2.75mm	1.75mm	#16	5.6mm	6.25mm	
#3	3.0mm	3.00mm	1.65mm	#17	5.8mm	6.50mm	
#4	3.2mm	3.25mm	1.60mm	#18	6.0mm	6.75mm	
#5	3.4mm	3.50mm	1.50mm	#19	6.2mm	7.00mm	
#6	3.6mm	3.75mm	1.40mm	#20	6.4mm	7.25mm	
#7	3.8mm	4.00mm	1.30mm	#21	6.6mm	7.50mm	
#8	4.0mm	4.25mm	1.20mm	#22	6.8mm	7.75mm	
#9	4.2mm	4.50mm	1.15mm	#23	7.0mm	8.00mm	

Fake Winding Arbors

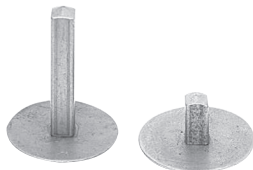

Used when replacing key-wind movements with quartz battery movements. Place the arbor in the winding holes giving the appearance of a key-wind movement & a more finished look. All metal. 3/4" mounting disc.

\$1.10 6+ **\$1.00**ea.

Arbor Length	Item No.
8mm	KFWA-8
24mm	KFWA-24

Plastic Key Holder



Mounts to the inside of the clock case. 1 dozen.
 Item No. **KH-542**

\$2.75doz.

Cuckoo Clock Parts & Accessories

Regula 1-Day Cuckoo Movements #25

Movement includes 2 chains, 2 stop rings, 2 hooks and all hand bushings.
Weights not included.



Item No.	Pendulum Length	MM Plate Sizes	Inch Plate Sizes
MC1-195	19.5cm (approx. 7-3/4")	73W x 63H	3-3/8"W x 2-1/2"H
MC1-235	23.5cm (approx. 9-1/4")	73W x 63H	3-3/8"W x 2-1/2"H

Pendulum Length is measured from the suspension spring post to the center of the pendulum leaf. Weight requirement is **320 grams** per weight.

\$54.95 2+ **\$52.95**ea.

Regula 8-Day Cuckoo Movements #34

Movement includes 2 chains, 2 stop rings, 2 hooks and all hand bushings.
Weights not included.



Item No.	Pendulum Length	MM Plate Sizes	Inch Plate Sizes
MC8-195	19.5cm (approx. 7-3/4")	85W x 76H	3-3/8"W x 3"H
MC8-235	23.5cm (approx. 9-1/4")	85W x 76H	3-3/8"W x 3"H
MC8-285	28.5cm (approx 11-1/4")	85W x 76H	3-3/8"W x 3"H

Pendulum Length is measured from the suspension spring post to the center of the pendulum leaf. Weight requirement is **1260 grams** per weight.

\$84.95 2+ **\$82.95**ea.

Regula 1-Day Musical Cuckoo Movements

Movement includes 3 chains, 3 stop rings, 3 hooks and all hand bushings.
Weights not included.

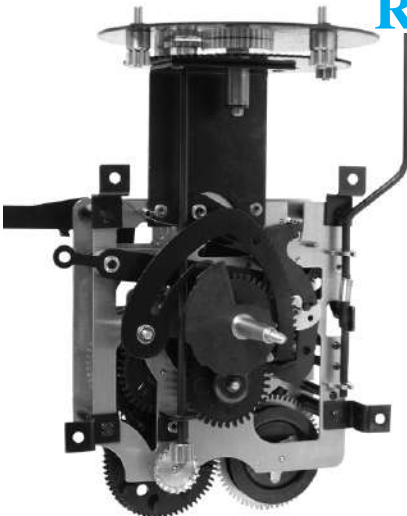

Item No.	Platform Height	Pendulum Length	MM Plate Sizes	Inch Plate Sizes
MC1M-19558	58mm	19.5cm	73W x 73H	2-7/8"W x 2-7/8"H
MC1M-23574	74mm	23.5cm	73W x 73H	2-7/8"W x 2-7/8"H

Pendulum Length is measured from the suspension spring post to the center of the pendulum leaf. Dancer Platform height is measured from the hand shaft to the top of the platform. Weight requirement is **320 grams** per weight.

MC1M-19558 **\$88.50** 2+ **\$86.50**ea.
MC1M-23574 **\$92.50** 2+ **\$90.50**ea.

Music Box Wheel

Slips on music box shaft and connects to music chain gear on #25 Regula dancing platform cuckoo movements. Comes with screw.

Item No. **CM-1** **\$4.95**



Trip Lever

Trip Lever for tripping the sound of a musical movement. Includes set screw.

Item No. **CM-2** **\$3.50**

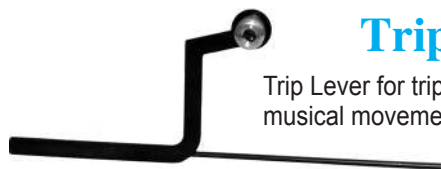

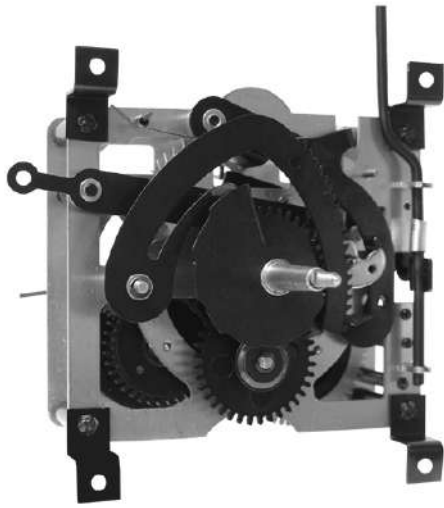

New Hubert Herr 1-Day Cuckoo Movements

Movement includes 2 chains, 2 stop rings, 2 hooks, hand nuts, and hand bushings.

Item No.	Pendulum Length	MM Plate Sizes	Inch Plate Sizes
MC1-15	15cm (approx. 5-7/8")	70W x 63H	2-3/4"W x 2-1/2"H
MC1-18	18cm (approx. 7-1/16")	70W x 63H	2-3/4"W x 2-1/2"H

Pendulum Length is measured from the suspension spring post to the center of the pendulum leaf. Weight requirement is **320 grams** per weight.

\$87.50ea.

New Mechanical Novelty Clock Kits

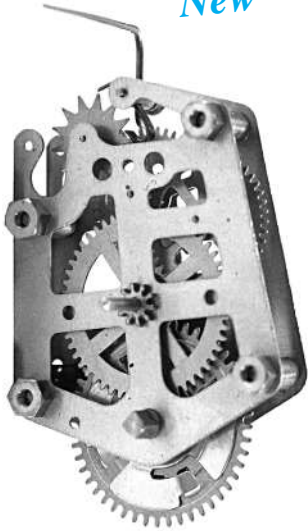

German made movements used in most novelty clocks.

1-7/16" wide, 2-1/8" tall, 11/16" deep

Complete with 2 hand shaft gears, 20mm (13/16") white hands, winding key, and 2 miniature acorn weights with side chains.

Mini Pendulum
2-5/8"H with
5/8" diameter.

Item No.
MCN-10
\$12.50

Bouncing Girl on
Swing Pendulum
Girl is
2-1/4"H x 1-1/4"W.

Item No.
MCN-15
\$16.50



Bouncing girl on swing is mounted to movement.

New Cuckoo & Westminster Chime Pendulum Movement

Made in Germany. Chimes cuckoo or Westminster on the hour. On/Off switch for cuckoo.

Includes:
2-15/16" pendulum, 1-5/8" paper dial,
hour and minute hands, bird, bird wire,
decorative chains and weights,
and mounting hardware.

Specifications:

Case Size:
2-11/16"W x 3-7/8"H x 1-1/2"D
Shaft Diameter: 5/16"
Threaded Shaft Length: 5/16"
Overall Shaft Length: 5/8"
Battery: 1 'AA' (not included)

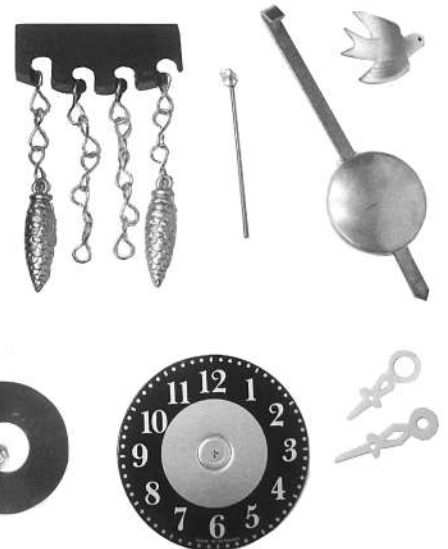
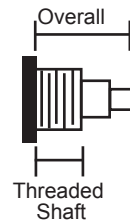

Item No. **MCC-100**

1	3	6+
\$19.95	\$18.95	\$17.95

Cuckoo Case Replacement Parts

Bird Crowns



Wood with brown stained finish. High quality carving. Complete with mounting screws attached on back. Measurements are from tip to tip at widest points on base of crown.

Size CM	Inches	Item No.	Price
17.5cm	7"	CC-240	\$13.95
20cm	7-7/8"	CC-241	\$16.95
23.5cm	9-1/4"	CC-242	\$22.95
32cm	12"	CC-243	\$30.95
35.5cm	14"	CC-244	\$38.95

Deer Crowns

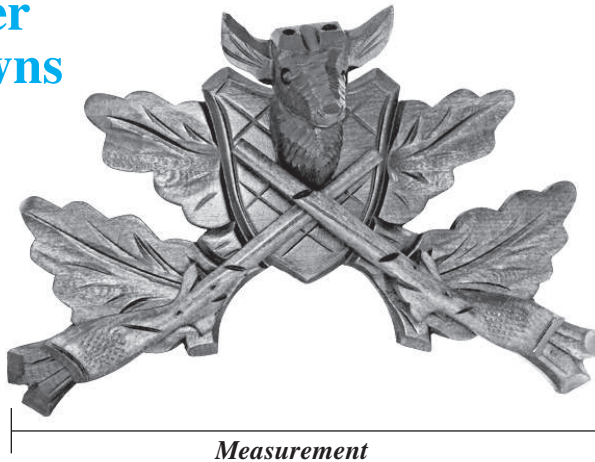

Wood with brown stained finish. High quality carving. Complete with deer head and mounting screws attached on back. Antlers sold separately. Measurements are from tip to tip at widest points on base of crown.

Size CM	Inches	Item No.	Price
21.5cm	8-1/2"	CC-250	\$38.50
29.5cm	11-1/2"	CC-251	\$47.50
35.5cm	14"	CC-252	\$67.50
44cm	17-1/4"	CC-253	\$117.50

Deer Heads

Wood with brown stained finish. High quality carving. Width from ear to ear. Height from top of head to bottom of neck.

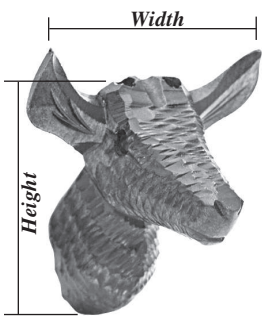

Size MM	Inches	Item No.	Price
55mm	2-1/8" x 2-1/2"	CC-260	\$17.50
75mm	3" x 3-1/2"	CC-261	\$25.50
90mm	3-1/2" x 4-1/2"	CC-262	\$33.95
140mm	5-1/2" x 5-3/4"	CC-267	\$47.95
175mm	6-7/8" x 7-3/4"	CC-268	\$89.95

Horn & Mouthpiece

Wood with brown stained finish. Measurement is the diameter of the horn opening.



Mouth Diameter	Item No.	Price
28mm	CC-281	\$5.25
35mm	CC-282	\$5.50
42mm	CC-283	\$5.95
55mm	CC-284	\$6.95
65mm	CC-285	\$7.50
85mm	CC-288	\$13.50

Antlers

Quality carving. Brown stained finish. Measurement from antler tip to bottom of mounting peg.

Wood



Size MM	Inches	Item No.	Price
75mm	2-15/16"	CC-270	\$9.95
90mm	3-1/2"	CC-271	\$14.95
127mm	5"	CC-272	\$26.95
170mm	6-3/4"	CC-273	\$44.95

Plastic



Measurement from antler tip to bottom of mounting peg.

Size MM	Inches	Item No.	Price
70mm	2-3/4"	CC-276	\$3.75
90mm	3-1/2"	CC-277	\$4.50
105mm	4"	CC-278	\$5.50
125mm	5"	CC-279	\$6.50

Cuckoo Bird Door

Wood with brown stain.



Size MM	Inches	Item No.
20 x 25	3/4 x 1"	CC-291
24 x 35	15/16 x 1-3/8"	CC-292
30 x 42	1-3/16 x 1-5/8"	CC-293

75¢ ea. or 12+ 65¢ ea.

Cuckoo Pendulums

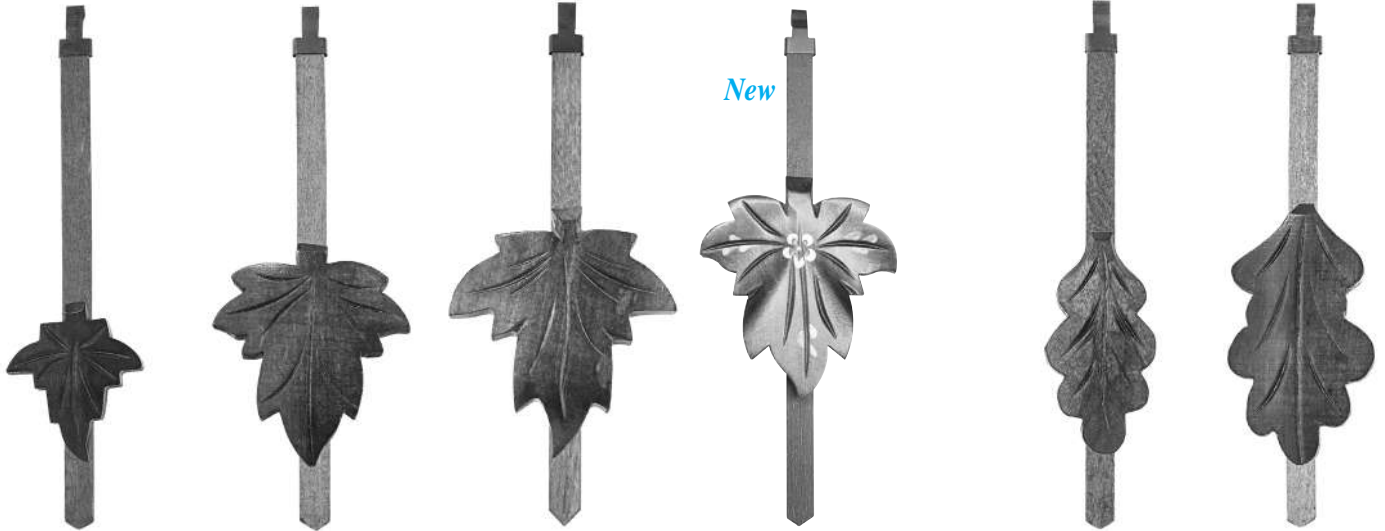

Maple Leaf

Wood with brown stained finish. 6-3/4" pendulum stick complete with hanger.

- | | | | |
|---|---|---|--|
| Small
2" Dia. Leaf (50mm)
Item No. CC-340 | Medium
2-1/2" Dia. Leaf (62mm)
Item No. CC-341
\$6.95 | Large
3" Dia. Leaf (76mm)
Item No. CC-342
3+ \$6.50 ea. | Flowered
2-1/2" dia. leaf (62mm)
Item No. CC-343 |
|---|---|---|--|

Oak Leaf

Wood with brown stained finish. 6-3/4" pendulum stick complete with hanger.

- | | |
|---|--|
| 2-1/2" Long
(62mm)
Item No. CC-350
\$6.95 | 3-1/2" Long
(89mm)
Item No. CC-351
3+ \$6.50 ea. |
|---|--|



Chalet

Wood. 6-3/4" pendulum stick with hanger.

- | | |
|--|--|
| Plain
2"w x 2-3/4"h
(50mm x 70mm)
Mahogany stain finish.

Item No. CC-360
\$4.50 3+ \$4.25 ea. | Flowered
2"w x 2-3/4"h
(50mm x 70mm)
Cherry stain finish with white & pink flowers & green leaves.

Item No. CC-361
\$5.95 3+ \$5.25 ea. |
|--|--|



Pendulum Sticks

With hook. Stained finish.

- | | |
|---|---|
| 6-3/4"
Item No. CC-370 | 9-7/8"
Item No. CC-371
\$1.25 6+ \$1.00 ea. |
|---|---|



Bouncing Girl

With 2" spring. Girl is 2-1/4" high. Overall length 5".
Item No. **CC-380**
\$5.75ea.



Zappler

Adjustable. Brass colored 5/8" dia. bob & 2-5/8" wire rod.
Item No. **PM-39**
\$1.20
12 for **\$1.00**ea.



Novelty

7/8" dia. brown wooden bob & 7-1/2" wire rod.
Item No. **PM-40**
\$1.50
12 for **\$1.25**ea.

May mix styles & sizes to receive quantity discounts.

Cuckoo Birds All complete with metal mount & adjustable screw.

Plastic



No Wings. Light grey body, moving red beak. 3" long (76mm).
Item No. **CC-219**
\$1.70 3+ **\$1.60**ea.



Fixed Wings. Painted blue wings, light grey body, moving red beak. 3" long (76mm).
Item No. **CC-220**
\$1.90 3+ **\$1.80**ea.



Fixed Wings. Dark grey wings, light grey body, moving red beak. 3" long (76mm).
Item No. **CC-221**
\$2.25 3+ **\$2.15**ea.



Swallow. Painted white and blue. 1" long (25mm).
Item No. **CC-222**

60¢ 3+ **50¢**ea.

Wooden



No Wings. Unfinished. Fixed red beak. 3-5/8" long (92mm). Item No. **CC-223**
\$5.25 3+ **\$5.00**ea.

New



Hand Carved, No Wings. Unfinished. Fixed red beak, pink embossed cheek feathers. 3-1/2" long (89mm).
Item No. **CC-224** **\$8.95**



Moveable Wings. Unfinished. Fixed red beak. 4" long (102mm).
Item No. **CC-225** **\$22.50**

New



No Wings. Beautiful detailing and workmanship. Light wood, unfinished body with hand painted fixed red beak and pink head crest. Fixed wing. 3-3/4" long (95mm).
Item No. **CC-226** **\$9.95**



Hand Carved Wings. Beautiful detailing and workmanship. Fixed wing. Dark blue/gray body with hand painted fixed black and red beak. Hand painted black and white feathers on chest. 3-3/4" long (95mm).
Item No. **CC-227** **\$9.95**

New Water Wheels



Painted to emulate water.
Item No. **CC-214** **\$4.95**ea.

Made in Germany.
2-1/4" dia., 1/2" depth,
wood with medium brown stain
and shiny finish.
Drilled back mounting hole,
1/8" dia.
(mounting hub not included).



Plain Item No. **CC-215**
\$3.95ea.

Cuckoo Figures

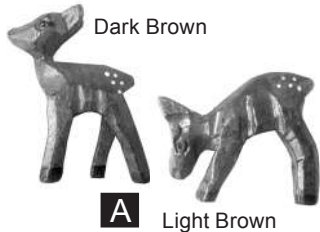

Dark Brown

A Light Brown

A) Deer. Wood, Hand Painted. **\$2.95**ea.
Item No. **CC-212** Standing 38mm (1-1/2") Tall
Item No. **CC-213** Kneeling 30mm (1-3/16") Tall



B

B) Music Man. Playing Accordion. Plastic with metal mounting & adjustable screw. White & green. 18mm (3/4") tall.
Item No. **CC-201** **\$3.25**ea.



C

C) Dancing Couple. Plastic, 2 color combinations to choose from. 28mm (1-1/8") tall. Hand painted. **\$1.90**ea.
Item No. **CC-202** Blue/Red Girl, Black/Grey Man
Item No. **CC-203** Green/Yellow Girl, Black/Brown Man



D

E) Small Novelty Boy & Girl. Wood, Hand Painted. **\$2.25**ea.
Item No. **CC-205** Girl: 33mm (1-5/16") Red, Black & White
Item No. **CC-206** Boy: 35mm (1-3/8") Green, Blk. & Brown



E

F) Large Novelty Boy & Girl. Sold separately. Hand painted. Wood. **\$2.50**ea.
Item No. **CC-207** Girl: 36mm (1-3/8"), red, black & white
Item No. **CC-208** Boy: 38mm (1-1/2"), green, red & black



F



G

G) Novelty Couple. Wood, Hand Painted. Red, black & white girl. Green & black man. 40mm (1-9/16") tall.
Item No. **CC-209** **\$4.25**ea.



H

D) Dancing Couple. Wood, Hand Painted. Blue & red girl, brown & black man. 42mm (1-5/8") tall.
Item No. **CC-204** **\$7.95**ea.

H) Novelty Band. Wooden 4 Pc. set. Accordion, Horn, Bell, Drum. 58mm (2-1/4") tall.
Item No. **CC-210** **\$20.95** set

Complete Bellow Sets

Standard Sizes

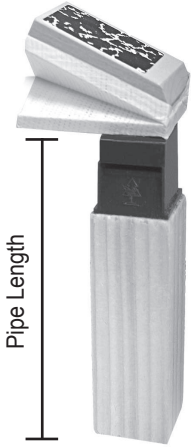

Pipe Length MM	Inches	Opening	Item No.	Price Per Pair
70	2-3/4	Back	CC-510	\$10.50
		Side	CC-511	
80	3-1/8	Back	CC-512	\$10.95
		Side	CC-513	
100	3-7/8	Back	CC-514	\$11.50
		Side	CC-515	
120	4-11/16	Back	CC-516	\$11.95
		Side	CC-517	
140	5-1/2	Back	CC-518	\$18.50
		Side	CC-519	
150	5-7/8	Back	CC-520	\$18.95
		Side	CC-521	
160	6-1/4	Back	CC-522	\$20.95
		Side	CC-523	

Antique Leather



Item No. **CC-500**
140mm, 5-1/2" Pipe
Trapezoidal

Item No. **CC-501**
150mm, 5-7/8" Pipe

Item No. **CC-502**
160mm, 6-1/8" Pipe
\$39.95 ea.

Quail



55mm,
2-1/8" Pipe

Item No.
CC-503
\$8.95

Horizontal & Vertical

Side Opening

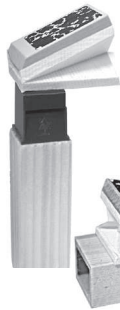

2 Horiz. 2-1/2" Pipes
Item No. **CC-504** **\$14.50** pr.

1 Horiz. 2-1/2" Pipe
1 Vertical 3-1/2" Pipe
Item No. **CC-505**
\$12.50 pr.

Variegated Replacement Paper

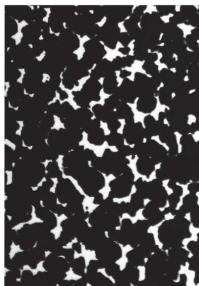

Pre-Cut Top Papers

Self-Stick. Yellow and Black. May be trimmed to fit other sizes. May mix sizes for quantity discounts.

Bellow Top Size MM	Item No.	Price Each		
		1	6	12
26 x 30	CC-607	50¢	45¢	40¢
27 x 37	CC-608			
30 x 43	CC-609			
37 x 53	CC-610			

Bulk Sheet Paper

Item No. **CC-611**

13-3/4" x 6-1/2". Yellow and Black. Glue Required. **\$4.25** ea.

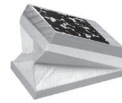

Bellow Tops

May mix sizes for quantity discounts.

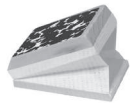

Item No.	Sizes		Price per Pair		
	MM	Inches	1	6	12+
CC-550	29x37	1-1/8 x 1-1/2	\$6.75	\$6.50	\$6.00
CC-551	29x44	1-1/8 x 1-3/4			
CC-552	33x44	1-5/16 x 1-3/4			
CC-553	33x50	1-5/16 x 2			
CC-554	33x56	1-5/16 x 2-1/4			
CC-555	40x60	1-9/16 x 2-3/8			

Trapezoidal Bellow Tops

Cloth

50x57mm, 2"x2-1/4" Item No. **CC-570**
\$14.50

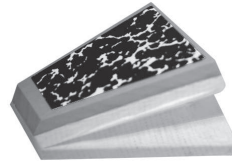

Leather

50x57mm, 2"x2-1/4" Item No. **CC-571**
\$24.50

Bellow Bag Pre-Cut Replacement Papers

May mix sizes for quantity discounts.



Bellow Top Size MM	Item No.	Price Each		
		1	6	12+
29 x 37	CC-600	\$1.00	95¢	90¢
29 x 44	CC-601			
33 x 44	CC-602	\$1.25	\$1.20	\$1.15
33 x 50	CC-603			
33 x 56	CC-604			
40 x 60	CC-605	\$1.50	\$1.45	\$1.40

Bellow Bag Sheet Paper

With instructions.

27" x 9" Item No. **CC-606-27**
\$6.50

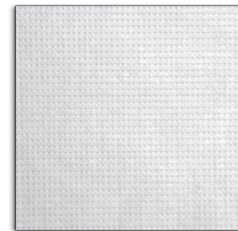

9" x 7" Item No. **CC-606-9**
\$2.50

Bellow Bag Replacement Leather

Approx. 36 to 38 Square Inches.

Item No. **CC-606**
\$19.95





Natural finish wood numerals on a stained time track.

Wooden Cuckoo Dials

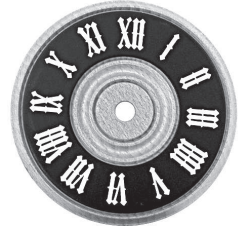

White painted numerals on a black time track.

Raised Wood Numerals

Item No.	Diameter		1
	MM	Inches	
CC-160W	60	2-3/8"	\$6.50
CC-170W	70	2-3/4"	\$6.25
CC-180W	80	3-1/8"	\$6.50
CC-190W	90	3-9/16"	\$7.00
CC-110W	100	3-15/16"	\$8.25
CC-111W	110	4-5/16"	\$8.50
CC-112W	120	4-3/4"	\$10.50
CC-113W	130	5-1/8"	\$11.95

Silk-Screened Numerals

Item No.	Diameter		1
	MM	Inches	
CC-160P	60	2-3/8"	\$4.50
CC-170P	70	2-3/4"	\$4.50
CC-180P	80	3-1/8"	\$5.00
CC-190P	90	3-9/16"	\$5.00
CC-110P	100	3-15/16"	\$6.00
CC-111P	110	4-5/16"	\$6.00



Cuckoo Numerals

Sold in sets of 1 -12



Wooden

Natural Finish

Item No.	Diameter		Price
	MM	Inches	
CC-301W	9	3/8"	\$1.50
CC-302W	11	7/16"	\$1.60
CC-303W	12	1/2"	\$1.70
CC-304W	14	9/16"	\$1.80
CC-305W	16	5/8"	\$1.90
CC-306W	20	13/16"	\$2.20
CC-307W	24	15/16"	\$2.70
CC-308W	28	1-1/8"	\$3.10

Plastic

Ivory Color

Item No.	Diameter		Price
	MM	Inches	
CC-309V	9	3/8"	\$1.20
CC-310V	11	7/16"	\$1.25
CC-311V	12	1/2"	\$1.30
CC-312V	14	9/16"	\$1.35
CC-313V	16	5/8"	\$1.45
CC-314V	20	13/16"	\$1.75
CC-315V	24	15/16"	\$1.95
CC-316V	28	1-1/8"	\$2.20

Novelty Hands

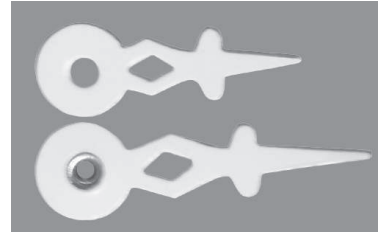

White Plastic with bushing.
 20mm (13/16") Minute Hand
 Item No. **CC-440**
 24mm (15/16") Minute Hand
 Item No. **CC-441**
\$1.20 pr.

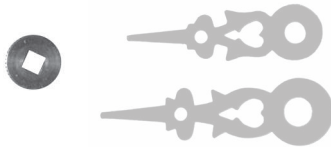

Cuckoo Hands

Minute hand is measured from the center of the hole to the tip. Sold by the Pair

Styles May Vary

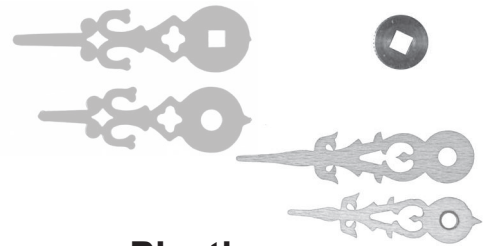

Wooden - Natural Finish

Minute Hand Length		Dial Dia. CM	Round Hole w/ Bushing Item No.	Price
MM	Inches			
26	1-1/16"	6	CC-420	\$3.95
30	1-3/16"	7	CC-421	\$3.95
36	1-7/16"	8	CC-422	\$3.95
40	1-9/16"	9	CC-423	\$4.25
48	1-7/8"	10/11	CC-424	\$4.50
57	2-1/4"	12	CC-426	\$4.75
64	2-9/16"	13/14	CC-427	\$5.25
70	2-3/4"	15/16	CC-428	\$6.00
82	3-1/4"	17/21	CC-429	\$6.50

Plastic - Ivory

Minute Hand Length		Dial Dia. CM	Round Hole w/ Bushing Item No.
MM	Inches		
26	1-1/16"	6	CC-414
30	1-3/16"	7	CC-415
36	1-7/16"	8	CC-416
40	1-9/16"	9	CC-417
48	1-7/8"	10/11	CC-418

\$1.50 pr. 12+ \$1.30 pr.

Plastic - White

Minute Hand Length		Dial Dia. CM	Square Hole 3.15mm Item No.	Round Hole w/ 2.50mm Bushing Item No.
MM	Inches			
22	7/8"	5	CC-400	CC-407
26	1-1/16"	6	CC-401	CC-408
30	1-3/16"	7	CC-402	CC-409
36	1-7/16"	8	CC-403	CC-410
40	1-9/16"	9	CC-404	CC-411
43	1-11/16"	10	CC-405	CC-412
50	2"	11	CC-406	CC-413
57	2-1/4"	12	—	CC-419
64	2-1/2"	13	—	CC-425

Cuckoo Hardware and Accessories



Cuckoo Weights

454 gr. = 1 lb.

Item No.	Weight		Price
	Grams	lb.-oz.	
CCW-150	150	5.3	\$4.95
CCW-200	200	7.06	\$5.25
CCW-250	250	8.82	\$4.95
CCW-275	275	9.7	\$4.95
CCW-320	320	11.29	\$4.95
CCW-375	375	13.23	\$5.25
CCW-420	420	14.82	\$5.50
CCW-500	500	1-1.6	\$7.00
CCW-630	630	1-6.2	\$7.75

Item No.	Weight		Price
	Grams	lb.-oz.	
CCW-750	750	1-10.5	\$7.95
CCW-875	875	1-14.9	\$8.75
CCW-1000	1000	2-3.2	\$11.00
CCW-1170	1170	2-9.3	\$11.50
CCW-1260	1260	2-12.4	\$12.00
CCW-1350	1350	2-15.6	\$14.50
CCW-1500	1500	3-4.9	\$12.50
CCW-1750	1750	3-13.7	\$15.50

Cuckoo Hand Bushings



Mfg.	Hole	Item No.	Price
Regula	Square	CC-809	\$4.25 dz.
	Round	CC-810	
Hubert Herr	1-Day	CC-811	\$2.50 3 pc. set
	8-Day	CC-812	\$2.50 2 pc. set



Mini Pine Cone Weight Set

For novelty clocks. Gold color. Set includes 2, 1" plastic weights with chain and 2 side chains.

Item No. **CCW-01** **\$2.00** set



Cuckoo Rings & Hooks

Finish	Style	Pcs.	Item No.	Price
Brass	1 Day	24pcs. (12 hooks, 12 rings)	CC-21B	\$3.25
	8 Day		CC-28B	
Antique Brass	1-Day	12pcs. (6 hooks, 6 rings)	CC-21A	\$4.25
	8-Day		CC-28A	

Cuckoo Chain

With Rings and Hooks



Mfg.	Mvmt.	Wire Dia.	Links per Ft.	Length	Item No.	Price
Regula <i>Brass Plated</i>	1-Day	.90mm	61	70"	CH-9063	\$6.95pr.
	8-Day	1.05mm	48		CH-10547	\$7.95pr.
Regula Antique Brass	1-Day	.90mm	61	70"	CH-9063A	\$9.95pr.
	8-Day	1.05mm	48		CH-10547A	\$15.95pr.
Hubert Herr	1-Day	.90mm	59	78"	CH-9059	\$9.25ea.
	8-Day	1.30mm	45	70"	CH-13045	\$10.50ea.



Cuckoo Flat Washers

Brass, 6.4mm O.D., 2.54mm I.D. 12 pcs. Item No. **CC-813**

\$2.50

Convex Hand Washers

Brass, for Cuckoo and French clocks. 8.25mm O.D., 2.4mm I.D. 12 pcs.

\$2.50

Item No. **CC-814**

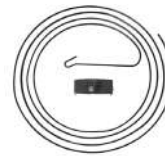

Cuckoo Gongs

With Bracket & Screw

Item No.	Diameter		Price
	MM	Inches	
CC-760	60	2-1/2	\$1.60
CC-770	70	2-3/4	\$1.75
CC-780	80	3-1/8	\$1.80
CC-790	90	3-5/8	\$1.95
CC-7100	100	4	\$2.30
CC-7120	120	4-3/4	\$2.80
CC-7140	140	5-1/2	\$3.60

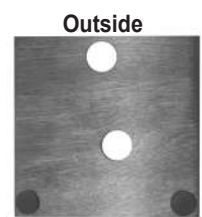
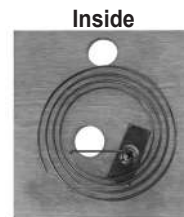

Cuckoo Back Door with Gong

Walnut stain exterior with 2 rubber protective pads. Interior mounted gong.

99 x 96mm (3-7/8" w x 3-13/16" h).
Gong Dia. 70mm (2-3/4")

Item No. **CCB-01** **\$8.95**

113 x 116mm (4-7/16" w x 4-5/8" h)
Gong Dia. 80mm (3-1/4")

Item No. **CCB-02** **\$8.95**

145 x 153mm (5-11/13" w x 6" h)
Gong Dia. 89mm (3-1/2")

Item No. **CCB-03** **\$9.95**

Cuckoo Hardware

Latches, Wires & Hinges

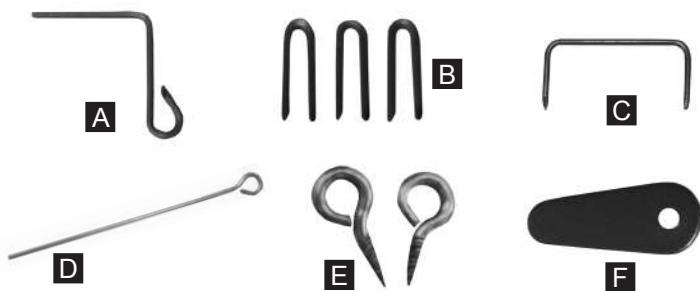

- A. Door Latch. 12 pc. #CC-800 **\$1.50**
- B. Door Hinges. 12 pc. #CC-801 **\$1.00**
- C. Door Hinge Wire. 12 pc. #CC-802 **\$1.20**
- D. Door Opener Wire. 6 pc. #CC-803 **\$1.20**
- E. Lift Wire Ring. 6 pc. #CC-804 **\$1.20**
- F. Back Door Latch #CC-805 **20¢ea.**

Crown & Pendulum Hardware

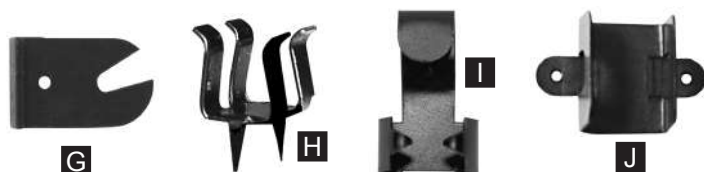

- G. Crown Holding Bracket #CC-806 **35¢ea.**
- H. Cuckoo Clock Top Clip #CC-806A **\$1.00ea.**
- I. Pendulum Hook #CC-807 **55¢ea.**
- J. Pendulum Regulating Slider #CC-808 **55¢ea.**

Cuckoo Clock Repair Made Simple



by
Tom
Seaman

Newly
Revised

For more info
see page 126

A complete guide for in depth cuckoo repair, written by a man with over 25 years experience.

Excellent for beginners or advanced repairmen with 135 clear black & white photos. 136 Pgs. 9x11". Soft cover.

BK-115 **\$29.95**
90

Cuckoo Clock Repair DVD



For more info
see page 131

Bruce Rasmessum

Complete cuckoo clock function, theory and repair is shown & explained. Plus much more! Enlarged color drawings and detailed close-up views are amply shown for clarity and understanding. A basic understanding of time & strike mvmts. is necessary. 105 minutes.

VDO-100 **\$39.95**

Pendulum Hangers

May mix sizes to receive quantity discount.

Size		Item No.	Size		Item No.
MM	Inches		MM	Inches	
80	3-1/8	CCH-080	120	4-3/4	CCH-120
90	3-5/8	CCH-090	130	5-1/8	CCH-130
100	4	CCH-110	140	5-1/2	CCH-140
110	4-1/4	CCH-110	150	5-7/8	CCH-150
60¢ea. 12+ 50¢ea.					

16 Pc. Assorted Pack

2 Pc. of each size listed above

Item No. **CCH-24** **\$6.40**

Bellow Lift Wires

May mix sizes to receive quantity discount.

Size		Item No.	Size		Item No.
MM	Inches		MM	Inches	
52	2-1/16	CCL-052	82	3-1/4	CCL-82
58	2-1/4	CCL-058	85	3-3/8	CCL-85
62	2-7/16	CCL-062	90	3-9/16	CCL-90
68	2-11/16	CCL-068	100	4	CCL-100
72	2-7/8	CCL-072	120	4-3/4	CCL-120
77	3-1/16	CCL-077	130	5-1/8	CCL-130
50¢ea. 12+ 40¢ea.					

24 Pc. Assorted Pack

2 Pc. of each size listed above

Item No. **CCL-36** **\$9.60**

O-Rings

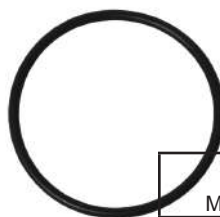

Size		Item No.
MM	Inches	
35 x 2	1-3/8 x 1/8	CC-820
55 x 1.5	2-1/8 x 1/16	CC-821
60 x 2	2-3/8 x 1/8	CC-822
80.5 x 1.5	3-1/8 x 1/16	CC-823
85 x 2	3-5/16 x 1/8	CC-824
\$2.90ea.		

All prices are subject to change without notice.



Mainsprings - Hole End



Mix & Match 10 of any hole and loop end mainsprings and get a 20% discount.

Width		Strength		Length Inches	Item no.	Price	
Inches	MM	Inches	MM			1	10+
3/32	2.3	.007	0.18	18	MS-100	2.25	1.80
5/32	4.0	.008	0.20	24	MS-101	5.25	4.20
5/32	4.0	.011	0.28	28-1/2	MS-103	3.25	2.60
3/16	4.8	.009	0.23	24	MS-104	3.50	2.80
7/32	5.6	.008	0.20	26	MS-105	5.25	4.20
7/32	5.6	.0095	0.24	24	MS-106	3.25	2.60
1/4	6.4	.010	0.25	24	MS-109	4.25	3.45
1/4	6.4	.011	0.28	39	MS-110	3.60	2.88
9/32	7.0	.007	0.18	44	MS-111	4.00	3.20
9/32	7.0	.010	0.25	18	MS-112	5.00	4.00
9/32	7.0	.010	0.25	39-1/2	MS-113	5.50	4.40
5/16	8.0	.008	0.20	27	MS-114	3.50	2.80
5/16	8.0	.010	0.25	28	MS-116	5.00	4.00
5/16	8.0	.010	0.25	32	MS-117	3.50	2.80
5/16	8.0	.010	0.25	39-1/2	MS-118	4.50	3.60
5/16	8.0	.011	0.28	45-1/4	MS-119	4.10	3.28
5/16	8.0	.015	0.38	40	MS-120	4.10	3.28
5/16	8.0	.016	0.41	54	MS-121	5.00	4.00
11/32	8.7	.013	0.33	66	MS-122	6.00	4.80
23/64	9.0	.011	0.28	45-1/2	MS-124	5.00	4.00
23/64	9.0	.0125	0.32	18-1/2	MS-125	3.50	2.80
3/8	9.5	.011	0.28	48	MS-126	4.55	3.64
3/8	9.5	.014	0.36	48	MS-127	5.50	4.40
3/8	9.5	.017	0.43	54	MS-128	5.00	4.00
25/64	10.0	.011	0.28	45-1/4	MS-130	4.35	3.48
25/64	10.0	.012	0.30	73	MS-131	6.25	5.00
7/16	11.0	.010	0.25	32-1/4	MS-132	3.85	3.08
7/16	11.0	.011	0.28	49	MS-135	6.00	4.80
7/16	11.0	.0155	0.40	55-1/2	MS-136	7.50	6.00
15/32	12.0	.010	0.25	39-1/2	MS-137	5.50	4.40
15/32	12.0	.012	0.30	53	MS-139	5.75	4.60
15/32	12.0	.014	0.36	72	MS-140	7.50	6.00
1/2	12.7	.012	0.30	48	MS4-1232	10.00	8.00
1/2	12.7	.013	0.33	27	MS4-1225	7.50	6.00
1/2	12.7	.013	0.33	60	MS-142	7.50	6.00
1/2	12.7	.015	0.38	23	MS4-1224	10.00	8.00
1/2	12.7	.015	0.38	36	MS-143	4.75	3.80
1/2	12.7	.016	0.41	65	MS-144	7.50	6.00
1/2	12.7	.018	0.46	60	MS-145	8.50	7.60
33/64	13.0	.010	0.25	39-1/2	MS-146	4.50	3.60
33/64	13.0	.011	0.28	45-1/4	MS-147	5.50	3.76
33/64	13.0	.012	0.30	53	MS-148	6.00	4.80
17/32	13.5	.010	0.25	72	MS-149	5.50	4.40
17/32	13.5	.014	0.36	38	MS4-1330	6.50	5.20
17/32	13.5	.022	0.55	28	MS4-1332	7.50	6.00
35/64	14.0	.011	0.28	45-1/4	MS-152	5.50	4.40
35/64	14.0	.011	0.28	49	MS-153	6.00	4.80
35/64	14.0	.012	0.30	61	MS-155	6.50	5.20
9/16	14.3	.012	0.30	39	MS-157	6.50	5.20
9/16	14.3	.013	0.33	27	MS4-1425	5.00	4.00
9/16	14.3	.014	0.36	32	MS4-1430	6.00	4.80
9/16	14.3	.015	0.38	42	MS-160	6.00	4.80
19/32	15.0	.011	0.28	45-1/4	MS-161	6.00	4.80
19/32	15.0	.011	0.28	49	MS-162	6.55	5.24
19/32	15.0	.012	0.30	53	MS-163	6.75	5.20
5/8	16.0	.010	0.25	39-1/2	MS-164	5.50	4.40
5/8	16.0	.011	0.28	45-1/4	MS-165	6.00	4.80
5/8	16.00	.011	.028	49	MS-166	7.75	6.20

Width		Strength		Length Inches	Item no.	Price	
Inches	MM	Inches	MM			1	10+
5/8	16.0	.013	0.33	78	MS-167	7.75	6.20
5/8	16.0	.013	0.33	105	MS-168	13.00	10.36
5/8	16.0	.014	0.36	70	MS-169	8.00	6.40
5/8	16.0	.016	0.41	59	MS-170	7.00	5.60
5/8	16.0	.0175	0.44	43-1/2	MS-171	9.00	7.20
5/8	16.0	.018	0.46	41	MS4-1636	7.00	5.60
5/8	16.0	.018	0.46	72	MS-173	8.50	7.20
5/8	16.0	.018	0.46	96	MS-174	9.50	7.60
43/64	17.0	.010	0.25	72	MS-176	9.00	7.20
43/64	17.0	.010	0.25	39-1/2	MS-177	6.25	5.00
43/64	17.0	.011	0.28	45-1/4	MS-178	7.75	6.20
43/64	17.0	.011	0.28	49	MS-179	6.00	4.80
43/64	17.0	.018	0.46	54	MS-180	10.00	8.00
11/16	17.5	.012	0.30	72	MS-181	9.50	7.68
11/16	17.5	.014	0.36	54	MS-182	9.50	7.60
11/16	17.5	.018	0.46	44	MS4-1838	9.50	7.60
11/16	17.5	.018	0.46	96	MS-184	10.00	8.00
45/64	18.0	.011	0.28	49	MS-186	8.25	6.60
45/64	18.0	.012	0.30	53	MS-187	8.25	6.56
45/64	18.0	.012	0.30	61	MS-188	8.25	7.60
45/64	18.0	.016	0.41	56	MS-189	8.50	6.80
45/64	18.0	.016	0.41	61-1/2	MS-190	8.50	6.80
45/64	18.0	.0175	0.44	70	MS-191	9.00	7.20
45/64	18.0	.019	0.48	47	MS-192	8.00	6.40
45/64	18.0	.021	0.53	48	MS-193	8.00	6.40
3/4	19.0	.009	0.23	72	MS-194	8.00	6.40
3/4	19.0	.010	0.25	39-1/2	MS-195	7.00	5.60
3/4	19.0	.011	0.28	45-1/4	MS-196	7.00	5.64
3/4	19.0	.011	0.28	49	MS-197	7.50	6.00
3/4	19.0	.011	0.28	50	MS-198	7.50	6.00
3/4	19.0	.012	0.30	53	MS-199	7.75	6.20
3/4	19.0	.012	0.30	61	MS-200	8.00	7.20
3/4	19.0	.012	0.30	75	MS-201	10.00	8.00
3/4	19.0	.012	0.30	90	MS-202	9.75	7.80
3/4	19.0	.013	0.33	54	MS-203	7.50	6.00
3/4	19.0	.014	0.36	90	MS-204	10.00	8.00
3/4	19.0	.015	0.38	72	MS-205	9.00	7.20
3/4	19.0	.0155	0.40	53-1/2	MS-206	7.50	6.00
3/4	19.0	.016	0.41	38	MS4-1932	8.00	7.20
3/4	19.0	.016	0.41	53	MS4-1938	10.00	8.00
3/4	19.0	.016	0.41	56	MS-209	8.00	6.40
3/4	19.0	.016	0.41	60	MS-210	8.00	6.40
3/4	19.0	.017	0.43	44	MS-211	7.25	5.80
3/4	19.0	.017	0.43	45	MS4-1936	7.50	6.00
3/4	19.0	.0175	0.44	70	MS-213	10.00	8.00
3/4	19.0	.018	0.46	96	MS-214	13.00	10.40
3/4	19.0	.019	0.48	68-1/2	MS-215	10.00	8.00
25/32	20.0	.011	0.28	45-1/4	MS-216	7.95	6.36
25/32	20.0	.011	0.28	49	MS-217	9.50	7.60
25/32	20.0	.012	0.30	53	MS-218	8.75	7.00
25/32	20.0	.012	0.30	61	MS-219	9.50	7.68
25/32	20.0	.0155	0.40	53	MS-220	8.00	7.20
25/32	20.0	.016	0.41	53	MS4-2038	10.00	8.00
25/32	20.0	0.175	0.44	70-1/2	MS-222	10.50	8.40
25/32	20.0	.018	0.46	76-1/2	MS-223	20.50	16.40
53/64	21.0	.011	0.28	45-1/4	MS-224	9.50	7.60
53/64	21.0	.011	0.28	49	MS-225	8.50	6.80

Mainsprings - Hole End, Continued

Width		Strength		Length Inches	Item no.	Price	
Inches	MM	Inches	MM			1	10+
53/64	21.0	.012	.030	53	MS-226	8.75	7.00
53/64	21.0	.012	0.30	61	MS-227	9.00	7.20
53/64	21.0	.0125	0.32	67	MS-228	11.75	9.40
13/16	12.5	.015	0.38	100	MS4-2150	13.00	10.40
7/8	22.2	.011	0.28	49	MS-230	8.70	6.96
7/8	22.2	.012	0.30	53	MS-231	9.00	7.20
7/8	22.2	.012	0.30	61	MS-232	9.50	7.60
7/8	22.2	.0125	0.32	67	MS-233	12.50	10.00
7/8	22.2	.013	0.33	72	MS-234	12.25	9.80
7/8	22.2	.0155	0.40	50	MS-235	9.00	7.20

Width		Strength		Length Inches	Item no.	Price	
Inches	MM	Inches	MM			1	10+
7/8	22.2	.0175	0.44	70	MS-236	12.00	9.60
7/8	22.2	.018	0.46	84	MS-237	12.00	9.60
7/8	22.2	.018	0.46	96	MS-238	18.00	14.40
7/8	22.2	.0195	0.50	56	MS-239	9.75	7.80
61/64	24.0	.0175	0.44	70	MS-240	12.80	10.24
61/64	24.0	.018	0.46	76-1/2	MS-241	15.00	12.00
61/64	24.0	.018	0.46	80-1/2	MS-242	14.00	11.20
63/64	25.0	.018	0.46	78-1/2	MS-243	14.00	11.20
1	25.4	.018	0.46	96	MS-244	22.00	17.60

Mix & Match 10 of any hole and loop end mainsprings and get a 20% discount.



Mainsprings - Loop End

Width		Strength		Length Inches	Item no.	Price	
Inches	MM	Inches	MM			1	10+
1/8	3.2	.010	0.25	19	MS-245	5.00	4.00
9/64	3.6	.009	0.23	25	MS-246	3.00	2.40
5/32	4.0	.009	0.23	26	MS-247	3.75	3.00
3/16	4.8	.010	0.25	23	MS-251	4.00	3.20
3/16	4.8	.012	0.30	31	MS-252	3.25	2.60
3/16	4.8	.016	0.41	54	MS-253	4.25	3.40
13/64	5.0	.0105	0.26	25-1/2	MS-254	3.50	2.80
7/32	5.6	.011	0.28	24	MS-255	3.50	2.80
7/32	5.6	.017	0.43	30	MS-256	3.75	3.00
1/4	6.4	.010	0.25	26	MS-257	5.00	4.00
1/4	6.4	.012	0.30	41	MS-259	3.50	2.75
1/4	6.4	.013	0.33	24	MS-260	4.25	3.40
1/4	6.4	.016	0.41	54	MS-261	4.50	3.60
9/32	7.0	.009	0.23	30	MS-262	3.95	3.16
9/32	7.0	.012	0.30	27	MS-263	4.50	3.60
9/32	7.0	.012	0.30	30	MS-264	5.25	4.20
9/32	7.0	.017	0.43	48	MS-265	6.00	4.80
19/64	7.5	.015	0.38	39	MS-266	8.00	6.40
5/16	8.0	.009	0.23	20	MS-267	3.75	3.00
5/16	8.0	.009	0.23	36	MS-268	3.95	3.16
5/16	8.0	.010	0.25	30	MS-269	4.00	3.20
5/16	8.0	.013	0.33	24	MS-270	4.75	3.80
5/16	8.0	.013	0.33	26	MS-271	4.75	3.80
5/16	8.0	.013	0.33	30	MS-272	5.50	4.40
5/16	8.0	.015	0.38	42	MS-273	5.50	4.40
5/16	8.0	.016	0.41	54	MS-274	5.50	4.40
5/16	8.0	.016	0.41	72	MS-275	8.00	6.40
5/16	8.0	.017	0.43	42	MS-276	3.75	3.00
5/16	8.0	.020	0.51	46	MS-277	6.75	5.40

Width		Strength		Length Inches	Item no.	Price	
Inches	MM	Inches	MM			1	10+
3/8	9.5	.011	0.28	51	MS-279	7.50	6.00
3/8	9.5	.013	0.33	34	MS-280	5.50	4.40
3/8	9.5	.014	0.36	48	MS-281	5.75	4.60
3/8	9.5	.014	0.36	60	MS-282	5.75	4.60
3/8	9.5	.015	0.38	53	MS-283	6.50	5.20
3/8	9.5	.016	0.41	60	MS-284	6.25	5.00
3/8	9.5	.017	0.43	96	MS-285	8.00	6.40
3/8	9.5	.019	0.48	48	MS-286	6.00	4.80
7/16	11.0	.014	0.36	72	MS-287	7.50	6.00
7/16	11.0	.018	0.46	48	MS-288	5.50	4.40
7/16	11.0	.018	0.46	60	MS-289	8.50	6.80
1/2	12.7	.015	0.38	84	MS-290	11.00	8.80
1/2	12.7	.016	0.41	66	MS-291	8.00	6.40
1/2	12.7	.018	0.46	60	MS-292	8.00	6.40
1/2	12.7	.018	0.46	96	MS-293	11.00	8.80
9/16	14.3	.015	0.38	78	MS-294	9.25	7.40
9/16	14.3	.018	0.46	96	MS-295	12.00	10.00
5/8	16.0	.013	0.33	69	MS-296	9.60	7.68
5/8	16.0	.018	0.46	96	MS-297	12.00	10.00
5/8	16.0	.024	0.60	108	MS-309	12.00	10.00
11/16	17.5	.015	0.38	108	MS-298	13.00	10.40
11/16	17.5	.018	0.46	96	MS-299	13.50	10.80
3/4	19.0	.012	0.30	72	MS-300	8.00	6.40
3/4	19.0	.014	0.36	108	MS-301	15.00	12.00
3/4	19.0	.016	0.41	78	MS-302	11.50	9.20
3/4	19.0	.017	0.43	120	MS-303	11.50	9.20
13/16	20.6	.018	0.46	96	MS-305	16.00	12.80
7/8	22.2	.018	0.46	96	MS-306	17.50	14.00
1	25.4	.018	0.46	96	MS-307	19.50	15.60

<p>For Fast & Easy Ordering Visit Our Website</p> <p>ronellclock.com</p>	<p>Toll Free: 1-800-334-0135 • Fax, 24 Hrs: 541-471-0099</p> <p>Mail in Orders:</p> <p>Ronell Clock Co., P.O. Box 5510, Grants Pass, OR 97527</p> <p>e-mail: info@ronellclock.com Info: 541-471-0194</p>
---	---



Hermle Barrels

Complete with Mainspring

Barrel No.	Item No.	Movement Plate Series Number & Train		
		Time	Strike	Chime
#10	MSH-10B	140 141-031	140 141	
#11	MSH-11B	140 781 141 791	141-031	
#20 & #21 <small>(Same Size)</small>	MSH-21B	150 151	150 151	
#31	MSH-31B		130 132	
#30 & #32 <small>(Same Size)</small>	MSH-32B	130 131		
#33	MSH-33B	132-071	131-030	
#40 & #42 <small>(Same Size)</small>	MSH-40B	340 341	340 341	
#41	MSH-41B			340 341
#50	MSH-50B	350 351 1050 1051	350 351 1050 1051	
#52	MSH-52B	350 351 1050 1051		
#54	MSH-54B			350 351 1051
#55	MSH-55B			351-030A 351-050 1050 1051
#56	MSH-56B		351-030 1051-030	
#57	MSH-57B	352 1052		



Hermle Mainsprings

Barrel No.	Item No.	Mainspring Size
		Inches & Metric Width x Strength x Length
#10	MSH-10M	43/64 x .0175 x 58-5/8" (17 x .45 x 1490mm)
#11	MSH-11M	43/64 x .0165 x 59-1/16" (17 x .42 x 1500mm)
#20 & #56 <small>(Same Size)</small>	MSH-20M	43/64 x .0150 x 47-1/4" (17 x .38 x 1200mm)
#21 & #50 <small>(Same Size)</small>	MSH-21M	43/64 x .0155 x 47-1/4" (17 x .40 x 1200mm)
#31	MSH-31M	15/32 x .0133 x 45-1/4" (12 x .34 x 1150mm)
#30 & #32 <small>(Same Size)</small>	MSH-32M	15/32 x .0165 x 43-5/16" (12 x .42 x 1100mm)
#33	MSH-33M	15/32 x .0120 x 45-1/4" (12 x .32 x 1150mm)
#40 & #42 <small>(Same Size)</small>	MSH-40M	43/64 x .0150 x 43-5/16" (17 x .38 x 1100mm)
#41	MSH-41M	53/64 x .0155 x 61" (21 x .40 x 1550mm)
#52	MSH-52M	43/64 x .0165 x 47-1/4" (17 x .42 x 1200mm)
#54	MSH-54M	53/64 x .0165 x 74-13/16" (21 x .42 x 1900mm)
#55	MSH-55M	53/64 x .0175 x 70-7/8" (21 x .45 x 1800mm)
#57	MSH-57M	43/64 x .0120x 59-1/16" (17 x .32 x 1500mm)

May mix barrels & mainsprings to receive quantity discounts.

Barrels

Barrel No.	1	3+
#10, #11	\$32.00	\$31.00
#31, 30/32, 33, 40/42, 50, 52, 56	\$31.50	\$30.50
#20/21, 41, 54, 55, 57	\$39.00	\$38.00

Mainsprings

Mainspring No.	1	3	6+
#10, 11, 57	\$10.00	\$9.75	\$9.50
# 20/56, 21/50, 40/42, 52	\$9.00	\$8.75	\$8.50
#30, 31, 32, 33	\$7.00	\$6.75	\$6.50
#41, 54, 55	\$12.50	\$12.25	\$12.00

*Great
Closeouts*

From Clocks to Crafts! All Items are at Great Prices!

1-of-a-kinds, stock reductions, buy outs, estate items and so much more!

Old and new. 1 to 100 pieces

Visit our website: ronellocks.com

and our e-bay store: stores.ebay.com/Ronell-Clock-Company

Kieninger Barrels with Springs



Item No.	Mvmt.	Train	No.	Price
MSK-9B	J	Time	#9	\$35.00
MSK-19B	J	Strike	#19	\$35.00
MSK-25B	J	Chime	#25	\$45.00
MSK-15B	RWS	Strike	#15	\$40.00
MSK-26B	RWS	Chime	#26	\$40.00



Kieninger Mainsprings - Hole End

Item No.	Mvmt.	Train	No.	Size-Inches	Size - MM	Price
MSK-25M	J	Chime	#25	25/32 x .0155 x 59-1/16"	20 x .40 x 1500	\$10.50
MSK-9M	J	Strike/Time	#9/#19	25/32 x .0155 x 43-5/16"	20 x .40 x 1100	
MSK-15M	RWS	Strike	#15	3/4 x .015 x 70-7/8"	19 x .38 x 1800	\$11.50
MSK-26M	RWS	Chime	#26	15/16 x .013 x 94-1/2"	24 x .33 x 2400	\$15.95



Commercial Mainsprings

Made From High Grade Japanese Steel

Item No.	End	Width		Strength		Length Inches	1	3	6	10+
		Inches	MM	Inches	MM					
MSC-400	Loop	5/8	16.0	.018	0.45	96	\$6.50	\$6.25	\$6.00	\$5.75
MSC-401	Hole	11/16	17.0	.018	0.45	96				
MSC-402	Hole	43/64	17.5	.018	0.45	70 3/4				
MSC-403	Hole	3/4	19.0	.018	0.45	70 3/4	\$7.50	\$7.25	\$7.00	\$6.75
MSC-405	Hole	7/8	22.2	.018	0.45	70 3/4				
MSC-406	Hole	7/8	22.2	.018	0.45	78 3/4	\$8.00	\$7.75	\$7.50	\$7.25
MSC-407	Hole	63/64	25.0	.018	0.45	70 3/4				



8-Day Mainsprings

Premium

High Grade Steel. Quality Construction. Loop End.

3/4 x .017 x 96"
MSC-504

1 **\$9.75** 6 **\$9.50**ea. 10+ **\$8.95**ea.

Commercial Grade

High Grade Japanese Steel. Loop End.

3/4 x .018 x 96" **MSC-404**
3/4 x .0165 x 96" **MSC-408**

1 **\$5.95** 6 **\$5.75**ea. 10+ **\$5.50**ea.

30 Hour Mainsprings

Loop End

Two sizes to choose from. May mix sizes to receive quantity discounts.

3/8" x .014 x 48"
Item No. **MSC-38**

5/16" x .015 x 42"
Item No. **MSC-516**

\$3.50 or 6+ **\$3.00**ea.

Seth Thomas #10 Mainspring



Item No. **MS-309**

Size 5/8" x .24 x 108". Loop End.

\$16.40 3+ **\$16.00**ea.



31 Day Mainspring

For Japanese and Korean 31-day clocks.

Item No. **MSC-409**
3/4" x .015 x 170". Loop End.

\$7.95 3+ **\$7.75**ea.



400-Day Mainsprings



Mix & Match 10 of any hole and loop end mainsprings and get a 20% discount.

MILLIMETERS					INCHES				Price	
Item No.	Spring Width		Inside Dia. of Barrel	Length	Thick-ness	Spring Width	Inside Dia. of Barrel	Length		Thick-ness
MS4-1224	12	x	24	584	.38	1/2	1	23	.015	10.00
MS4-1225	12	x	25	697	.33	1/2	1	27	.013	7.50
MS4-1232	12	x	32	1232	.30	1/2	1-1/4	48	.012	10.00
MS4-1330	13	x	30	972	.36	17/32	1-3/16	38	.014	6.50
MS4-1332	13	x	32	714	.55	17/32	1-1/4	28	.022	7.50
MS4-1425	14	x	25	697	.33	9/16	1	27	.013	5.00
MS4-1428	14	x	28	720	.41	9/16	1-1/8	28	.016	10.00
MS4-1430	14	x	30	815	.36	9/16	1-3/16	32	.014	6.00
MS4-1432	14	x	32	1041	.46	9/16	1-1/4	41	.018	10.00
MS4-1636	16	x	36	1039	.46	5/8	1-7/16	41	.018	9.00
MS4-1838	18	x	38	1118	.46	11/16	1-1/2	44	.018	9.50
MS4-1932	19	x	32	951	.41	3/4	1-1/4	38	.016	8.00
MS4-1936	19	x	36	1143	.43	3/4	1-7/16	45	.017	7.50
MS4-1938	19	x	38	1346	.41	3/4	1-1/2	53	.016	10.00
MS4-2038	20	x	38	1346	.41	25/32	1-1/2	53	.016	10.00
MS4-2150	21	x	50	2540	.38	13/16	1-15/16	100	.015	13.00

Kieninger Winding Arbor Bushings

22 mm dia.



Movement	Position	Train	Inside Dia.	Item No.	Price
KSU, KS RSU	Front	Chime	6.5mm	BLG-01 (Beveled Top)	\$7.50
	Front	Time/Strike	6.5mm	BLG-02	\$4.00
	Back	-----	3.0mm	BLG-03	\$4.00
HSU, HTU	Front	Chime	5.5mm	BLG-04	\$7.50

Winding Arbor Bushings

For American & other clocks



BLG-06
Time

75¢ ea.

6+ **70¢** ea.



BLG-07
Strike

Head Dia.	Barrel Dia.	Inside Dia.	Height
.315"	1/4"	.19"	1/8"
.33"	1/4"	.19"	1/4"

Brass Bushing Assortment

100 pieces



For grandmother, wall & mantle clocks. Has small pivot holes to be broached to size.

Item No. **BLG-08**

\$11.50

Large Winding Arbor Bushing Assortment



4pc. Winding arbor or grandfather pivot bushings. 1 ea. of 5/16", 3/8", 7/16" and 1/2" inside diameters.

Item No. **BLG-09**

\$2.50

"The System" Bushings

Interchangeable with KWM Bushings
 Superior Quality - American made hard brass bushings.
 All measurements shown below are metric.



Our chart is easy to understand.

- 1) The 1st column groups the bushings according to the outside diameter.
 - 2) The 2nd column gives the corresponding KWM Reamer number.
 - 3) The 3rd column gives the Bore or Inside Diameter of the bushing.
 - 4) The Height (plate thickness) of the bushings are grouped across the top of the chart.
- Order # = Equivalent reference number to KWM Bushings.
 X = No equivalent reference number to KWM Bushings.

When Ordering: Please give us the **ORDER NUMBER** and the **QUANTITY** of the bushing you want. Example: #43 - 20 pcs. or #15 - 50 pcs. etc.
 Use the *System* number only IF there is no Order number shown.

BUSHING DIAMETER	REAMER	BORE	HEIGHT									
			1.4mm		1.9mm		2.7mm		3.5mm			
			O.D.	DIA.	I.D.	System#	Order#	System#	Order#	System#	Order#	System#
1.80 Reamer Dia. 1.78	Reamer Number 2	0.3	21403	64								
		0.4	21404	08	21900	Blank						
		0.5	21405	09	21905	32						
		0.6	21406	10	21906	33						
		0.7	21407	11	21907	34						
	Reamer Dia. 1.78	0.8	21408	12	21908	35						
		0.9	21409	13	21909	36						
		1.0	21410	65	21910	37	22700	Blank				
		1.0	31410	14	31900	Blank	32700	Blank	33500	Blank		
		1.1	31411	15	31911	38	32711	100	33511	x		
2.70 Reamer Dia. 2.68	Reamer Number 3	1.2	31412	16	31912	39	32712	101	33512	x		
		1.3	31413	17	31913	40	32713	102	33513	x		
		1.4	31414	18	31914	41	32714	103	33514	x		
		1.5	31415	19	31915	42	32715	104	33515	x		
		1.6	31416	20	31916	43	32716	105	33516	x		
	Reamer Dia. 2.68	1.7	31417	67	31917	88	32717	106	33517	x		
		1.8	31418	21	31918	44	32718	107	33518	x		
		1.9	31419	68	31919	89	32719	108	33519	x		
					41900	Blank	42700	Blank	43500	Blank		
		2.0	41420	22	41920	45	42720	109	43520	x		
3.50 Reamer Dia. 3.48	Reamer Number 4	2.1	41421	69	41921	90	42721	110	43521	x		
		2.2	41422	23	41922	46	42722	111	43522	x		
		2.3	41423	70	41923	91	42723	112	43523	x		
		2.4	41424	24	41924	47	42724	113	43524	x		
		2.5	41425	71	41925	92	42725	114	43525	x		
		2.6	41426	25	41926	48	42726	115	43526	x		
		2.7	41427	72	41927	93	42727	116	43527	x		
5.90 Reamer Dia. 5.85	Reamer Number 5	3.0				51900						
		3.2				51930	50	52730	118			
		3.2				51932	51	52732	119			
		3.4				51934	81	52734	120			
		3.6				51936	52	52736	121			
		4.0				51940	83	52740	123			
		4.4				51944	84	52744	125			
		4.8				51948	85	52748	127			

#21403 to #45500
 Available in
 20 pc. or 50 pc.
 Packs Only

#51900 to #52748
 Available in
 25 pc.
 Packs Only

BUSHING DIAMETER	REAMER	BORE	4.0mm		5.5mm				
			O.D.	DIA.	I.D.	System#	Order#	System#	Order#
			2.70 Dia. 2.68	3	1.9				
		#35500 to #45500						35500	Blank
		Available in 20 or 50 pc. Packs							
3.50 Dia. 3.48	4	2.7							
							45500	Blank	
8.70 Dia. 8.64	Reamer Number 6	5.0	64050	128					
		5.4	64054	130			#64050 to #64066		
		5.8	64058	132			Available in		
		6.2	64062	134			10 pc.		
		6.6	64066	136			Packs Only		

Bushings per Package	1	10+
10 pcs.	\$11.50	\$11.25
20 pcs.	\$7.50	\$7.25
25 pcs.	\$14.00	\$13.75
50 pcs.	\$16.00	\$15.50

"The System" Bushing Assortments

100 pcs. \$37.00 ea.

BA-1: Contains all 1.4mm high bushings. Perfect for many of the American movements, alarms, meters & other applications. Size#: 14, 15, 16, 17, 18, 19, 20, 67, 21, 68.

BA-2: Our BEST SELLER. Perfect for the majority of American movements, most late German clocks and more. Size#: 37, 38, 39, 40, 41, 42, 43, 88, 44, 89.

BA-3: For many early German, English & other heavy plate clocks. Also for meters, mechanical toys and other applications. Another excellent seller. Size#: 100, 101, 102, 103, 104, 105, 106, 107, 108, 109.

BA-4: Extension of #3. Larger diameter bores for large pivots. Size#: 107, 108, 109, 110, 111, 112, 113, 114, 115, 116.

BA-5: Contains all 3.5mm high bushings. Perfect for Herschede, early English & German clocks with thicker plates. Size#: 33511, 33512, 33513, 33514, 33515, 33516, 33517, 33518, 33519, 43520.

BA-6: An extension of #5 for Herschede & antique clocks. Size#: 33518, 33519, 43520, 43521, 43522, 43523, 43524, 43525, 43526, 43527.

Bronze Bushing Assortments

For KWM American made in KWM sizes

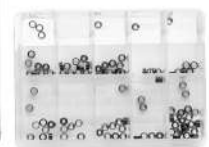

100 pcs.,
 10 of each size

Item No. **KZA-1**
 Sizes: 14-21, 67 & 68 \$25.00 ea.

Item No. **KZA-2**
 Sizes: 36, 37, 39, 40-44, 88, 89

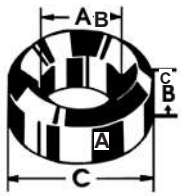

Bergeon Bushings

Solid Brass. Made in Switzerland by Bergeon. 10 pc. Pack

May mix style & sizes to receive quantity discounts.

Bushing No.	1	10+
00 - 24 31 - 58	\$3.60	\$3.35
25 - 30 59, 60	\$4.60	\$4.35

A Outside Dia.	B Inside Dia.	C Height	Reamer	Bergeon No.	10 Pc. Pk. Order No.
2.0	0.30	1.5	15	31	BB31-10
2.0	0.30	2.8	15	00	BB00-10
2.0	0.35	1.5	15	32	BB32-10
2.0	0.40	1.5	15	1	BB1-10
2.0	0.40	2.0	15	33	BB33-10
2.0	0.40	2.8	15	0	BB0-10
2.0	0.45	2.0	15	34	BB34-10
2.0	0.50	1.2	15	35	BB35-10
2.0	0.50	1.5	15	2	BB2-10
2.0	0.50	2.0	15	36	BB36-10
2.0	0.55	1.5	15	37	BB37-10
2.0	0.60	1.5	15	3	BB3-10
2.0	0.60	3.0	15	4	BB4-10
2.0	0.65	2.0	15	38	BB38-10
2.0	0.70	1.5	15	5	BB5-10
2.0	0.70	3.0	15	6	BB6-10
2.0	0.75	2.0	15	39	BB39-10
2.5	0.80	1.5	16	7	BB7-10
2.5	0.80	3.0	16	8	BB8-10
2.5	0.85	2.0	16	40	BB40-10
2.5	0.90	1.5	16	9	BB9-10
2.5	0.90	3.0	16	10	BB10-10
2.5	0.95	1.2	16	41	BB41-10
3.0	1.00	1.5	17	11	BB11-10
3.0	1.00	2.0	17	42	BB42-10
3.0	1.00	3.0	17	12	BB12-10
3.0	1.10	2.0	17	43	BB43-10
3.0	1.20	2.0	17	44	BB44-10
3.0	1.25	1.5	17	13	BB13-10
3.0	1.25	2.0	17	45	BB45-10
1.25	3.0	3.0	17	14	BB14-10

A Outside Dia.	B Inside Dia.	C Height	Reamer	Bergeon No.	10 Pc. Pk. Order No.
3.0	1.30	2.0	17	46	BB46-10
3.5	1.40	2.0	18	47	BB47-10
3.5	1.50	1.5	18	15	BB15-10
3.5	1.50	2.0	18	48	BB48-10
3.5	1.50	3.0	18	16	BB16-10
3.5	1.60	1.5	18	49	BB49-10
3.5	1.65	2.0	18	50	BB50-10
3.5	1.70	2.0	18	51	BB51-10
3.5	1.75	1.5	18	17	BB17-10
3.5	1.75	3.0	18	18	BB18-10
3.5	1.80	2.0	18	52	BB52-10
3.5	1.90	2.0	18	53	BB53-10
4.5	2.00	1.5	19	19	BB19-10
4.5	2.00	2.0	19	54	BB54-10
4.5	2.00	3.0	19	20	BB20-10
4.5	2.10	2.0	19	55	BB55-10
4.5	2.25	1.5	19	21	BB21-10
4.5	2.25	2.0	19	56	BB56-10
4.5	2.25	3.0	19	22	BB22-10
4.5	2.40	2.0	19	57	BB57-10
4.5	2.50	1.5	19	23	BB23-10
4.5	2.50	3.0	19	24	BB24-10
4.5	2.75	2.0	19	58	BB58-10
5.5	3.00	1.5	20	25	BB25-10
5.5	3.00	3.0	20	26	BB26-10
6.5	4.00	1.5	21	27	BB27-10
6.5	4.00	3.0	21	28	BB28-10
8.5	5.00	2.0	23	59	BB59-10
7.5	5.00	3.0	22	29	BB29-10
8.5	6.00	3.0	23	30	BB30-10
8.5	6.50	2.0	23	60	BB60-10

Bergeon Bushing Assortments



#4165 Popular Bronze Assortment
For alarm clocks to regulators. 225 Pcs.
10 bushings ea. #1-15.
5 Bushings ea. #16-30.

Item No. **BBA-4165** **\$78.00**

#4166 Popular Brass Assortment
For alarm clocks to regulators. 225 Pcs.
10 bushings ea. #1-15.
5 Bushings ea. #16-30.

Item No. **BBA-4166** **\$68.00**

#6607 KWM Brass Assortment
For alarm clocks to regulators. 210 Pcs.
7 bushings ea. #11-22 and #33-45
Also #66, 67, 68, 88, 89.

Item No. **BBA-6607** **\$68.00**

#5456 Popular Brass Assortment
For alarm clocks to regulators. 225 Pcs.
10 bushings ea. #31-45.
5 Bushings ea. #46-60.

Item No. **BBA-5456** **\$68.00**

#5488 Master Brass Assortment
For alarm clocks to regulators. 450 Pcs.
10 bushings ea. #1-15 and #31-45.
5 Bushings ea. #16-30 and #46-60.

Item No. **BBA-5488** **\$118.00**

#6717 Ex Large Brass Assortment 5mm High.
For clocks to regulators. 210 Pcs.
7 busings ea. #101-130.

Item No. **BBA-6717** **\$98.00**

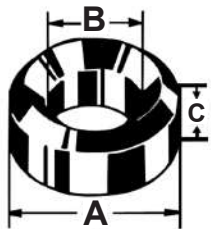

American Made Bronze and Brass Bushings

Bergeon Sizes - 20 pc. Pack

May mix sizes to receive quantity discounts.

1	3	12+
\$4.75	\$4.50	\$4.25

N/A = Not Available

Bergeon No.	A Outside Dia.	B Inside Dia.	C Height	Reamer Size	Ronell Bronze Item No.	Ronell Brass Item No.
31	2.0	0.30	1.5	15	BZ-31	BR-31
32	2.0	0.35	1.5	15	BZ-32	BR-32
1	2.0	0.40	1.5	15	BZ-01	BR-01
33	2.0	0.40	2.0	15	BZ-33	BR-33
34	2.0	0.45	2.0	15	BZ-34	BR-34
2	2.0	0.50	1.5	15	BZ-02	BR-02
36	2.0	0.50	2.0	15	BZ-36	BR-36
37	2.0	0.55	1.5	15	BZ-37	BR-37
3	2.0	0.60	1.5	15	BZ-03	BR-03
4	2.0	0.60	3.0	15	BZ-04	BR-04
38	2.0	0.65	2.0	15	BZ-38	BR-38
5	2.0	0.70	1.5	15	BZ-05	BR-05
6	2.0	0.70	3.0	15	BZ-06	BR-06
39	2.0	0.75	2.0	15	BZ-39	BR-39
41	2.5	0.80	2.5	16	BZ-41	BR-41
7	2.5	0.80	2.5	16	BZ-07	BR-07
8	2.5	0.80	2.5	16	BZ-08	BR-08
40	2.5	0.85	2.5	16	BZ-40	BR-40
9	2.5	0.90	2.5	16	BZ-09	BR-09
10	2.5	0.90	2.5	16	BZ-10	BR-10
11	3.0	1.00	3.0	17	BZ-11	BR-11
42	3.0	1.00	3.0	17	BZ-42	BR-42
12	3.0	1.00	3.0	17	BZ-12	BR-12
43	3.0	1.10	3.0	17	BZ-43	BR-43
44	3.0	1.20	3.0	17	BZ-44	BR-44
13	3.0	1.25	3.0	17	BZ-13	BR-13

Bergeon No.	A Outside Dia.	B Inside	C Height	Reamer Size	Bronze Item No.	Brass Item No.
45	3.0	1.25	3.0	17	BZ-45	BR-45
14	3.0	1.25	3.0	17	BZ-14	BR-14
46	3.0	1.30	2.0	17	BZ-46	BR-46
47	3.5	1.40	2.0	18	BZ-47	BR-47
15	3.5	1.50	1.5	18	BZ-15	BR-15
48	3.5	1.50	2.0	18	BZ-48	BR-48
16	3.5	1.50	3.0	18	BZ-16	BR-16
49	3.5	1.60	1.5	18	BZ-49	BR-49
50	3.5	1.65	2.0	18	BZ-50	BR-50
51	3.5	1.70	2.0	18	BZ-51	BR-51
17	3.5	1.75	1.5	18	BZ-17	BR-17
18	3.5	1.75	3.0	18	BZ-18	BR-18
52	3.5	1.80	2.0	18	BZ-52	BR-52
53	3.5	1.90	2.0	18	BZ-53	BR-53
19	4.5	2.00	1.5	19	BZ-19	BR-19
54	4.5	2.00	2.0	19	BZ-54	BR-54
20	4.5	2.00	3.0	19	BZ-20	BR-20
55	4.5	2.10	2.0	19	BZ-55	BR-55
21	4.5	2.25	1.5	19	BZ-21	BR-21
56	4.5	2.25	2.0	19	BZ-56	BR-56
22	4.5	2.25	3.0	19	BZ-22	BR-22
57	4.5	2.40	2.0	19	BZ-57	BR-57
23	4.5	2.50	1.5	19	BZ-23	BR-23
24	4.5	2.50	3.0	19	BZ-24	BR-24
58	4.5	2.75	2.0	19	BZ-58	BR-58
59	8.5	5.00	2.0	23	N/A	N/A

Bergeon Reamers *Swiss Made*

\$18.95 ea.

3+ \$18.75 ea.

\$28.50 ea.



TR-14B
1.20mm



TR-15B
1.97mm



TR-16B
2.47mm



TR-17B
2.97mm



TR-18B
3.47mm



TR-56B
3.97mm



TR-57B
4.97mm



TR-58B
5.97mm



TR-19B
4.47mm

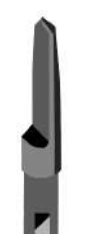

TR-20B
5.47mm



TR-21B
6.47mm



TR-22B
7.47mm



TR-23B
8.47mm



TR-59B
6.97mm



TR-60B
7.97mm



TR-61B
8.64mm

Bergeon Bushing Machine

High quality, durability & precision accuracy for perfect centering. Bushes plates from 50mm to 220mm with a pillar height up to 70mm. For use with Bergeon Bushings.

Includes:

- | | |
|-------------------------------|--------------------------|
| 1 Tool with 2 arms & 2 chucks | 1 Broach with hand wheel |
| 3 Driving punches | 1 Centering Bit |
| 1 Undrilled Stake | 1 Centering stake |
| 4 Drilled stakes | 10 Reamers |
| 1 Chamfering tool | 1 Acces. Storage Box |



Item No. **TM-1** **\$765.00**

Hand Bushing Tools

American Made

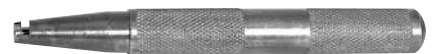
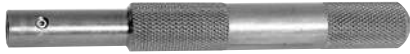

Bergeon

For use with Bergeon Bushings

8 pc., 5 reamers (1.97, 2.47, 2.97, 3.47, 4.47mm), 1 small chamfering cutter, handle & allen wrench.



Item No. **TR-40** **\$74.95**

KWM

For use with KWM or System Bushings

7 pc., 5 reamers (1.2, 1.8, 2.7, 3.5, 5.9mm), 1 chamfering cutter & handle.



Item No. **TR-38** **\$79.95**

Adaptor Chucks

Fits Bergeon machine to hold KWM reamers.

Item No. **TR-29** **\$8.50**



Fits KWM machine to hold Bergeon reamers. With allen wrench.

Item No. **TR-30** **\$8.50**



Handles

For use with KWM reamers.

Item No. **TR-39** **\$11.50**



For use with Bergeon reamers. With allen wrench.

Item No. **TR-41** **\$11.50**

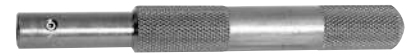

American Made Reamers

Bergeon Sizes

For Bergeon machines and hand tools.



TR-15AB
1.97mm



TR-16AB
2.47mm



TR-17AB
2.97mm



TR-18AB
3.47mm



TR-19AB
4.47mm

KWM Sizes

For Bergeon machines and hand tools.



TR-01B
1.2mm



TR-02B
1.8mm



TR-03B
2.7mm



TR-04B
3.5mm



TR-05B
5.9mm



TR-06B
8.7mm



TR-07B
Chamfer

KWM Sizes

For KWM machines and hand tools.



TR-01K
1.2mm



TR-02K
1.8mm



TR-03K
2.7mm



TR-04K
3.5mm



TR-05K
5.9mm



TR-06K
8.7mm



TR-07K
Chamfer

\$14.75ea. 3+ **\$14.50**ea.

May mix styles & sizes to receive quantity discounts.

Floating Holding Jaws

For Bergeon Bushing Tool



The longer jaw reach makes bushing easier and more versatile on small or odd shaped plates, increasing accuracy. Complete with 2 versatile spring loaded floating jaws and 2 extra tall spring loaded shafts. Easily mounts to bushing machine.

Item No. **TM-1A**
\$82.50

Tools and Accessories

Keystone Mainspring Winder

Outstanding design features make this winder, safe, fast, versatile and easy to use.

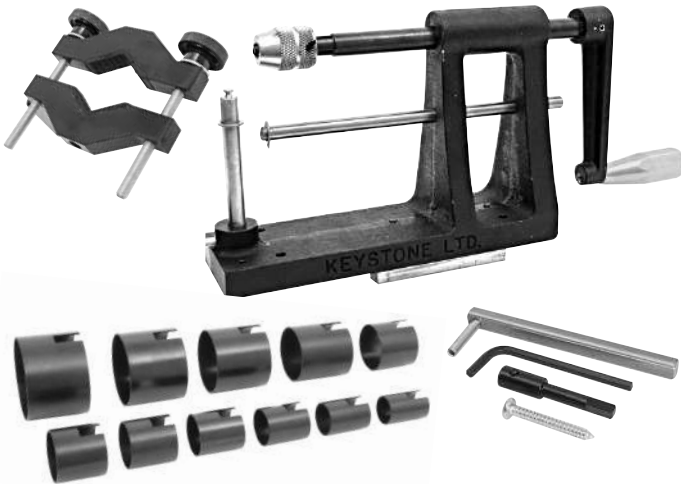

Features: Winds, unwinds, inserts or removes mainspring smoothly & safely. Adjustments are done by hand with no hooks, ratchet, or tools required. Safety clamp holds mainspring barrels firmly while removing or inserting without distortion or damage to the barrel. Adjusts to all barrel sizes then anchors firmly to the tool. Positive sliding lock handle allows turning in either direction. Handle locks by sliding the auxiliary post in place. Square chuck has a gripping range of 2 to 5mm (#0 to #13 key size), with no damage to arbor. Can be mounted to a bench, wall or in a vise.

Complete with winder, barrel clamp, 11 retainers (sizes 7/8", 1", 1-1/8", 1-1/4", 1-3/8", 1-1/2", 1-5/8", 1-7/8", 2-1/8", 2-3/8", 2-5/8" inside dia.), anchor pins for loop and hole-end mainsprings, 5 piece universal arbor set, 4 mounting screws, hex wrench & instructions.

Item No. **TM-2** **\$375.00**

Accu Mainspring Winder

Ollie Baker Style



Item No. **TM-11**
\$230.00

One of the highest quality winders on the market. Heavy duty aluminum main frame eliminates twisting, machined & fitted to close tolerance. Bottom extension bolts to bench or use in vise. Complete with nine steel mainspring sleeves: 7/8", 1", 1-1/8", 1-1/4", 1-3/8", 1-1/2", 1-5/8", 1-7/8", 2-1/8" (inside dia.). Left & right turning handle with steel ratchet & pin system for safe locking. 3 spring end holders for hole or loop ends.

Must be used with let-down chucks, sold separately.

Let-Down Chucks See page 80 for photo

Set of 3 sizes:
5/6, 7/8, 10/12)

Set of 6 sizes: 1/2, 3/4, 5/6,
7/8, 10/12 & 14/16).

Item No. **KLD-04** **\$33.75** | Item No. **KLD-07** **\$48.75**

Hand Held Mainspring Winder

Loop End

Wind springs on your clock's wheel & arbor. Use your own clock key of bench key for winding. Secure with "C" clamps (See Item No. TL-01 or TL-02 below).



Item No. **TM-12** **\$8.95**

ACCESSORIES

Adapter for Winder Arbors

Larger than 5mm.

Item No. **TM-2A** **\$28.00**



Winding Arbor Support

Tail Stock

Item No. **TM-2S** **\$75.00**



Wood Base for Winder

6" x 12". Will hold all barrels, accessories and mount winder.

Item No. **TM-2B** **\$26.95**



Steel Mainspring Sleeves



Item No. **TM-10A**

\$41.00

For use on any brand winder. 9 pc. assortment in sizes 7/8", 1", 1-1/8", 1-1/4", 1-3/8", 1-1/2", 1-5/8", 1-7/8", 2-1/8" inside diameter.

Round Mainspring "C" Clamps

Round, set of 4. Sizes 1-3/8", 1-7/8", 2-3/8" & 3" dia.

Item No. **TL-01** **\$5.25**



Flat Mainspring "C" Clamps

Set of 2, 1-15/16" dia., 5/16" width.

Item No. **TL-02** **\$5.95**



Flexible Shaft Machine With FREE 149 pc. Accessory Kit!!! A \$50.00 Value



A great machine for drilling, polishing, burring, milling, slotting, sawing, buffing & grinding. 1/4HP motor with ON/OFF switch. Variable speed 20,000 RPM, 120V, 250W. 39" flexible shaft, variable speed foot control & hanging bracket. 4mm Jacob type chuck.

Accessories (with 1/8" shanks) include: Stainless steel burs: cylinder file, narrow cone file. Screw mandrel & point mandrel. Mounted points: (100 grit) - sm. cone, knife-edge wheel; (220 grit) - lrg. cone, cylinder & barrel. 2 rubber abrasive band mandrels: 1/2"x1/2", 1/4"x1/2". Cup brush, steel wire brush, wire wheel & oil stone. Sanding discs: 24 pc. 3/4" coarse, 36 pc. 7/8" .6mm, 24 pc. 8" .8mm. Sanding drums: 6 pc. 1/4" #80 grit, 6 pc. 1/2" #120 grit. 5 pc. fiberglass wheels, #100 grit. 6 cloth polishers. Felt polishers: 1 cone, 1-7/8" wheel, and more!

Item No. TM-7 **\$132.50**

New Lead Melting Pots

Lee Pro 4-20 Melter

Large dia., holds approx. 20 lbs. of lead. 4" clearance under spout. Adjustable guide for accurate positioning of mold. Long life 700-watt tubular heating element. Micro adjustable, flow control valve. Front mounted replaceable valve spout allows for reseating with a screwdriver.



Item No. TM-3 **\$96.95**

Lee Precision Melter

High speed melter, infinite heat control. Handles 4-cavity molds. 15 min. to melt 4 lbs. of metal. 500 watt AC only, 110V.



Item No. TM-4 **\$49.95**

New Ingot Mold

Cast 1/2 & 1 lb. ingots. Perfect for remelting & alloying.



Wood handles, rustproof aluminum.

Item No. TM-5A **\$15.95**

New Lead Ladle

Works well for right and left handers, for skimming and stirring metal.



Item No. TM-5B **\$7.95**

Magnetizer & Demagnetizer



Only takes 5 seconds! Insert object into the large 3" x 1-1/2" opening, push the button & retract the object. 4-3/4"W x 3-1/2"H x 2-1/2"D.

Item No. TL-04 **\$69.95**

3" Bench Grinder

with Flexible Shaft Grinder

Variable speed up to 10,000 RPM, arbor size 10mm, wheel size 3", overall size 8-1/2" x 4-1/2" x 6-1/4". 3 prong plug, double insulated wires.



Item No. TM-6 **\$79.95**

Plate Spreader & Truing Tool

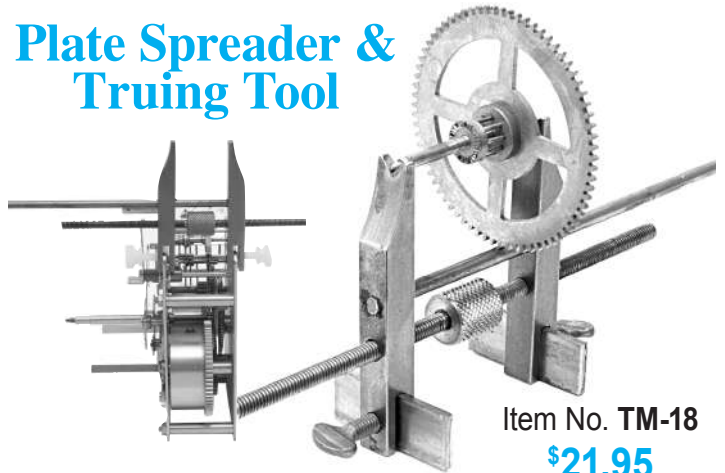

Item No. TM-18 **\$21.95**

Two tools in one. Use as a plate spreader with nylon or brass screws. You can make adjustments during movement assembly. Can be used as truing up tool. Use the included brackets and place a wheel and arbor in the slot.

Rotary Paper Dial Cutter

7/8" dia., high speed steel blade. Cuts circles from 1-1/8" to 13". 8" long.

Item No. TL-146 **\$12.95**

Extra Blade **\$3.00** ea.

Item No. TL-146A



Jewelers Anvil

Solid chrome steel head. 4-1/4" L x 1" W head with 1 rounded & 1 rectangular tapered extension. Heavy 2-3/4" dia. base for stability.

Item No. **TL-15** **\$14.95**

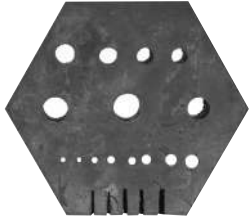

Hexagon Anvil

Solid steel, 1-3/4" dia. It has 15 graduated holes & 5 milled slots. Excellent for staking & riveting jobs.

Item No. **TL-16** **\$11.95**



Crows Foot

100's of uses. Great for any job involving friction fittings. Remove gears from shafts, stake pinions, and much more. Mounts securely into any vice or bench block. Solid black oxidized steel. 4-1/2" H, 3-1/2" L foot & 3/4" W.

Item No. **TL-17** **\$10.50**

Carbide Scriber



6" overall length. Metal handle. Item No. **TL-74** **\$4.95**

Automatic Centering Punch



For punching or scribing. 1" long hardened steel center point. 3-3/4" knurled brass handle.

Item No. **TL-56** **\$5.95**

8 Piece Carbon Steel Punch Set



1" shank, 4" length with knurled metal handle. Sizes 1/16", 3/32", 1/8", 5/32", 3/16", 7/32", 1/4" and 5/16". Includes pouch.

Item No. **TL-57** **\$14.95**

New Micro Screw Gripper



For holding tiny machine screws. Smooth inner jaws, spring loaded. Opens approx. 4mm. 4" total length.

Item No. **TL-58** **\$8.95**



Heavy Duty Hand Punch Set

Drop forged & heat treated. Will pierce up to 14 gauge mild steel. Can be used on steel, brass, copper, aluminum, plastic, leather & vinyl, etc. Includes: tool, punches / dies, die key, heavy plastic storage case, 7 round punches & 7 dies in sizes 3/32", 1/8", 5/32", 3/16", 7/32", 1/4" & 9/32".

Item No. **TL-07** **\$38.95**

New Riveting Hole Punch

Use one side for drilling 1/16" hole and the other side for riveting in metal gauge up to 12 SWG thick. 2-7/8"W x 1"H. Made in India.

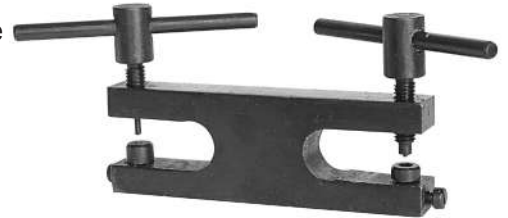

Item No. **TL-160** **\$12.95**

7 pc. Hole Closing Punches

Used for reducing hole sizes in brass plates, meters, etc. Spring center guides punch so that it will be concentric. Punch is tapped with small hammer. Sizes #1/0 (2mm), #1 (2.1mm), #2 (2.6mm), #3 (3.0mm), #4 (3.5mm), #5 (4.1mm), #6 (4.6mm). Includes plastic storage cylinder & lid. 2-5/8" long.



Item No. **TL-54** **\$38.95**

Swiss Universal Burnisher & Pivot File



For finishing pivots after repair. Polished, slightly rounded corners, 7" long.

Right Item No. **TL-72** **\$69.50** ea.

Burnisher



Hardened steel. 2 sided - polishing & grinding, 7" long.

Item No. **TL-71** **\$16.95**

Broaches & Countersinks

Bergeon Cutting Broaches

High quality, larger sized for instruments and larger clocks. Set of 6 pcs. - No. 32, 28, 24, 20, 8, A. 2.92-5.97mm.

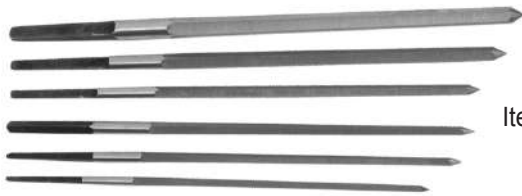

Item No. **TL-40**
\$59.95

Cutting Broaches

12 pieces for enlarging pivot holes. 5 sided. Sizes from 15 to 70.

Item No. **TL-41**

Rounding Broaches

12 pieces for finishing/burnishing pivot holes. Popular sizes from 15 to 70.

Item No. **TL-42**

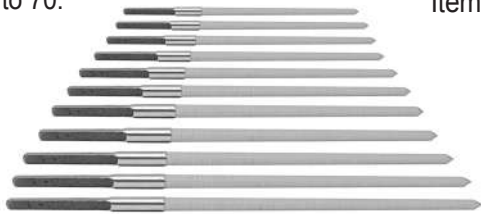

\$36.50 ea.

Extra Fine Cutting Broach Set

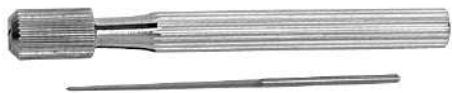

Item No. **TL-43**
\$22.95

Made in Germany of high carbon cutting steel. 5 sided. Features a miniature pin vice, 12 tiny broaches from .05mm to .55mm and a plastic storage case.

Cutting Broaches with Handles

German made. 6 piece assortment in sizes #46 to #72. (English stubs gauge). 5 sided, plastic handles.



Item No. **TL-44** **\$13.95**

6 pc. Bergeon Countersinks Set



High quality hardened steel. 6 double-end wheels. For removing burrs from plate holes after reaming or drilling, countersinking bushings, etc. Sizes 1.80/2.10mm, 2.50/2.80mm, 3.00/3.30mm, 3.50/3.80mm, 4.00/4.30mm, 4.50/5.00mm.



Item No. **TL-45** **\$74.95**

Wrenches & Clamps

Quartz Movement Nut Wrench

For quartz movement mounting nuts with 1/4", 5/16", 3/8" and 1/2" spans.

Item No. **TL-108** **\$8.50**

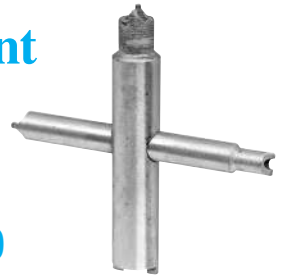

Miniature Adjustable Wrenches

Forged steel, precision machined, chrome plated. 2-1/2" wrench opens to 1/4". 4" wrench opens to 9/16".



2-1/2" Size Item No. **TL-123** **\$3.50** 2 for **\$6.50**
 4" Size Item No. **TL-124** **\$3.75**

Small Parts Drilling Clamp

Max. holding power & leverage. Holds work securely without whipping while drilling. Easy alignment, drill bit & small parts are visible at all times. Drill hands, washers, wheels & clicks, etc. 4"x4" aluminum block, 1/2" thick. Steel thumb screw & bolt adjusts to angle aluminum clamp.



Item No. **TL-03** **\$22.50**

Rubber Head Clamp

Ten times the power of spring clamps for holding a wide range of objects up to 1/4" thick. Rubber pads prevent surface damage. 3" long. 3/4" deep.

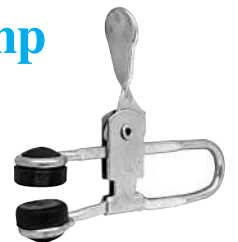

Item No. **TL-99** **\$1.50** ea. 4 for **\$5.00**

6 pc. Alligator Clips

Metal 3/4" long jaws. 2" overall length. Opens to 3/8".



Item No. **TL-98** **\$1.75** pkg.

Vises

Universal Parts Holder

Great for holding odd shaped items. 2" dia. aluminum jaws on twin guides, adjusts with thumb screw. Jaws open to a total dia. of 2-7/8". 8 steel pegs can be positioned in any configuration to hold items. Wood handle.

Item No. **TL-75** **\$16.95**



Bench Vice

Quality solid steel construction. Clamps or screws to bench. 2" wide jaws. Jaws open to 1-5/8". Overall length 5-1/4".

Item No. **TL-100**
\$10.95



Swivel Head Bench Vice

Quality aluminum & steel construction. Clamps to bench with a protective rubber pad that won't mar counter surface. 3" wide hard rubber knurled jaws to protect metals while holding securely. Head swivels (even vertically) then locks in place. Jaws open to 2-1/4". 10-1/4" overall height.

Item No. **TL-101**
\$21.95



Hemostats

For hard to reach areas and handling small parts. Can be used as a clamp, heat sink or third hand. Serrated locking jaws, rubber dipped with insulated handles. 6" long.



Straight Jaw

Item No. **TL-121**

Curved Jaw

Item No. **TL-122**

\$3.50 ea.

Large Pin Vice



Item No. **TL-151** **\$9.95**

For large hard to handle jobs. Un-breakable plastic handle with metal 3-jaw screw chuck. Opens up to 1/4". 6" long.

4 pc. Pin Vice Set

All steel construction. Opening sizes: 0 to .8mm, .8 to 1.3mm, 1.3 to 3.1mm, 3.1 to 4.8mm. Knurled handle with metal 4-jaw chucks.

Item No. **TL-46** **\$11.95**



4pc. Swivel Pin Vice Set

Complete with carrying pouch and 4 double ended chucks with opening from:

0 - 1/32" 1/32" - 1/16"
1/16" - 3/32" 3/32" - 1/8"

Item No. **TL-47** **\$13.95**



Swiss Style Pin Vice



"Swiss Style", double end, 2 chucks. Vice is 4-1/2" long. Two chucks with opening capacity of .039" to .098".

Item No. **TL-48** **\$3.50**

Pin Vice With Collets



Complete with 2 double-end, reversible collets. Collets can be stored in shaft of vice. Swivel head. Great for holding wire, small broaches, taps, screwdriver tips & more. Vice is 3-5/8" long. Collet opening sizes: .5mm & 3mm; .5mm & 2mm.

Item No. **TL-49** **\$4.50**

Order on-line. Visit our website:

ronellclock.com

For Orders Only
Call Toll Free

1-800-334-0135

Pliers & Tweezers

Euro Tool Parallel Pliers



Excellent quality at an affordable price. Available in chain smooth jaw or flat serrated. 5-1/2" long gives a superior hold.

Chain Smooth Jaw Item No. **TL-138C** **\$21.50** ea.
Brass Smooth Jaw Item No. **TL-138B** **\$25.50** ea.

4 pc. Stainless Steel Plier Set



Quality box joint set with a plastic partitioned carrying pouch. Insulated rubber handles & return spring action. Includes 1 ea. of serrated chain, 3/16" wide smooth jaw flat nose; 1-3/8" long smooth jaw needle nose; side cutter. Pliers approx. 5-1/2" long.

Item No. **TL-118** **\$16.95**

New Screw Holding Tweezers

Stainless steel.
4-3/4" long.

Item No. **TL-21S**



\$4.00

6 pc. ESCA Jeweler's Pliers & Cutters

Box joint construction, vinyl cushion grips provide comfort and retains precise alignment. Includes carrying pouch. Made in Italy.

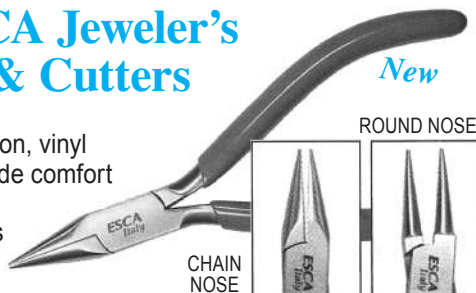

New

ROUND NOSE

CHAIN NOSE

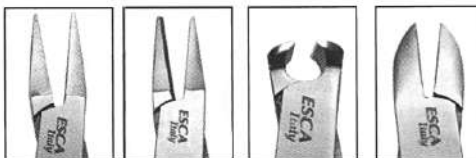

FLAT NOSE ROUND/FLAT END CUTTER DIAG. CUTTER

Item No. **TL-116**
\$88.95

New 3 pc. Titanium Tweezer Set

Titanium tweezer set includes sizes AA, 1, and 5 in a plastic pouch.



Item No. **TL-20-3** **\$14.95**

5 pc. Antimagnetic Tweezer Set

European quality stainless steel with balanced weight and precision tips. Includes sizes AA, 1, 3, 5, and 7A in a plastic pouch.



Item No. **TL-20-5** **\$15.95**

12 pc. Precision Tweezer Set

Item No. **TL-20-12**
\$13.50

New



12 of the most popular styles of stainless steel tweezers in a plastic storage pouch.

Sharp Point Tweezers

Stainless steel, Boley shape, AA style. 5" long.



Item No. **TL-21** **\$2.00**

Locking Grip Tweezers



TL-22

TL-23



Stainless steel with easy grip, heat resistant handle. Cross-bent construction, ideal for soldering & holding small objects.

Bent Blade Item No. **TL-22** **\$3.95** ea. 2 for **\$7.00**
Straight Blade Item No. **TL-23**

Ideal-Tek Non-Magnetic Tweezers

New



Made in Switzerland. Precision quality, stainless steel. Indented shanks, beveled edges, extra-honed needle sharp points. Excellent for microscopic parts. 4-1/2" overall length.

#5 Tapered Blade Item No. **TL-24-5** **\$26.00**
#3C Tapered Blade Item No. **TL-24-3** **\$18.00**

Pivot Locator



8" Long. Knurled handle. Item No. **TL-18** **\$4.95**

Pivot Locator



9-1/2"L allows for easy positioning, relocating & holding during assembly of movements. Easy grip knurled aluminum handle with steel hooked shaft.

Item No. **TL-19** **\$4.95**

5 pc. Dental Pick Assortment

Stainless steel single end pick set. Versatile tip assortment aids in hobby projects, gluing, circuit probing, micro work, clock & watch repair & more.



Item No. **TL-70** **\$5.95**

Brass & Fibre Hammer



Metal head with interchangeable 5/8" diameter ends. Shellacked hardwood handle.

Replacement Ends

Type	Item No.	Price
Brass	TL-12B	\$1.60
Fibre	TL-12F	\$1.60
Nylon	TL-12N	\$1.60

Item No. **TL-12** **\$10.50**

Brass & Nylon Hammer



Brass head & aluminum knurled handle. 1/2" brass end & 3/8" nylon end. 8-3/4" long.

Item No. **TL-13** **\$8.95**

Ballpein Hammer



Made of drop-forged steel, mounted on hardwood handles and secured with a metal wedge. Two sizes to choose from.

2oz. - 8-5/8" Item No. **TL-14A** **\$5.50**

4 oz. - 10-3/8" Item No. **TL-14B** **\$6.25**

Digital Calipers

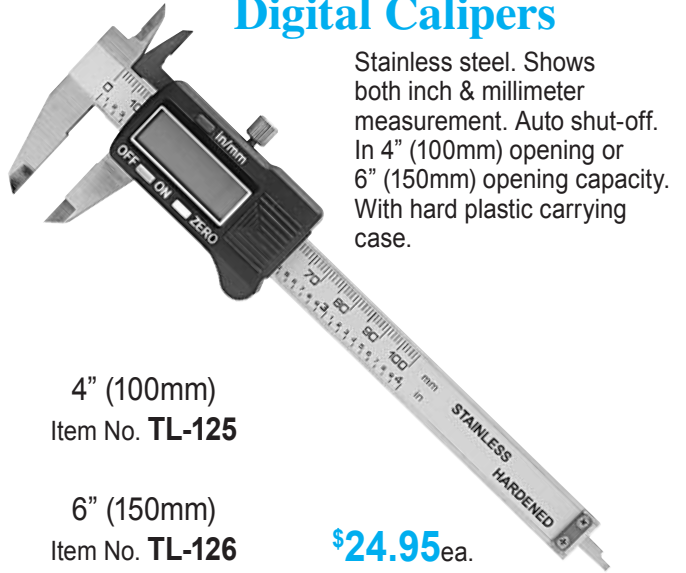

Stainless steel. Shows both inch & millimeter measurement. Auto shut-off. In 4" (100mm) opening or 6" (150mm) opening capacity. With hard plastic carrying case.

4" (100mm)

Item No. **TL-125**

6" (150mm)

Item No. **TL-126**

\$24.95ea.

Stainless Steel Double Sided Ruler



6" long. Measurements in standard S.A.E. & metric.

Item No. **TL-129** **\$2.95**

Direct Import

Bubble Level



1-1/2" L x 1/2"W x 1/2"H, Clear plastic with black base. Green liquid.

Item No. **TL-25**

360° Level

2" diameter base & 1-1/4" diameter bubble with orientation marks, plastic.



Item No. **TL-26**

Can Mix Styles to Receive Quantity Price Breaks

\$1.20

\$1.00ea.

90¢ea.

New Pivot Centering Hook



With wooden handle.

Item No. **TL-161** **\$4.95**

Pullers and Removers

Bergeon Universal Puller

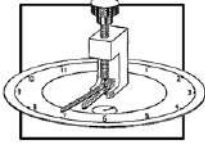

Top quality, heavy duty. 4 sizes of foot opening: 6mm/5mm, 4mm/2mm.

Item No. **TL-60**

\$54.95

Replacement Blades

6mm/5mm

Item No. **TL-60A**



\$5.00 ea.

4mm/2mm

Item No. **TL-60B**

Universal Puller

Made for pulling gathering pallets, hands and gears. 1-11/16" H x 1-3/16" W x 3/16" thick metal body with 3mm wide claw foot opening. Comes with 2 - 3" long steel screws with brass knurled knobs, and 1mm & 2mm wide tips.



Item No. **TL-65**

\$11.95

Large Lever Style Clock Hand Remover



Metal, 2 piece set, also use to lift or pry. 10mm wide tip (3/8") x 5" long.

Item No. **TL-66L** **\$18.95** pair

New Cannon Pinion Remover for Watches

Removes all sizes easily. With sturdy jaws and side springs.

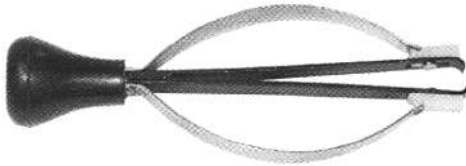

Item No. **TL-68B**

\$13.25

Small Lever Style Clock Hand Remover



Metal, 2 piece set also to use to lift or pry. 3mm wide tip x 4" long.

Item No. **TL-66S** **\$3.75** pair

Hand & Gear Puller

Light to Medium Duty



For all types of instruments & clocks. Jaws open to 7/16" wide. Fit jaws over hands & the pusher is always centered. Screw pressure pulls the hand or gear away from the post or pinion. Accomodates posts to 1/16" wide.

Item No. **TL-62** **\$22.95**

Plunger Style Hand Remover

Item No. **TL-67** **\$9.50**

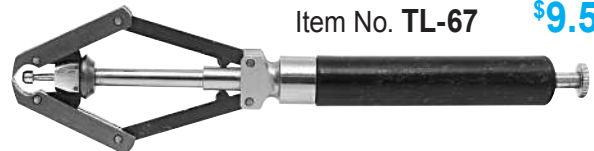

For watches & small instruments or clocks. A fast & effective way to remove hands. Just push downward on the plunger handle. The center guide post holds hands securely after removal. 4-1/2" long.

Clock Hand Remover

Will not harm dial or hands. Will accomodate hands up to 5/8" wide & posts to 9/32" wide. Jaw spread 1/4". Slide under hands & screw pressure pulls the hands from the post.



Item No. **TL-63** **\$4.95**

Hand Nut Adjusting Tool

Used by the factory to rotate minute hand bushings for precise adjustments. Tapered square shaft to fit any size bushing. Wood handle, steel shaft. 7-1/4" long.



Item No. **TL-104** **\$8.25**

Presto Style Hand Remover

Fiber tipped blocks rest on dial. Jaws retract when slide springs are pressed. Center plunger holds hands firmly after removal. Will not harm dial or hands.



Item No. **TL-68A**

\$10.95

3 Pc. Wire Bending Tools



3 End sizes. Reach into any movement to adjust wires, hammers or position pivots during reassembly.

Item No. **TL-107** **\$9.95**

Screwdrivers

Screw Holding, Quick Wedge Screwdrivers

For use on slotted screws.



The metal tube slides forward over the two spring steel blades to wedge the tip in the screw slot. Plastic handle & tube are insulated against electric shock.

B = Beveled tip for smaller screws.

Item No.	Width	Blade Sizes Thickness	Length	Overall Length	Price
TL-32	1/8" B	.012"	3"	5"	\$8.95
TL-33	1/8"	.020"	3"	5"	\$8.95
TL-34	1/8" B	.020"	3"	5"	\$8.95
TL-35	1/8"	.020"	8"	10"	\$9.45
TL-36	1/8" B	.020"	8"	10"	\$9.45
TL-37	3/16"	.031"	4"	6-1/2"	\$8.95

French 9 pc. Screwdriver Set



Premium set of nine color-coded screwdrivers includes 19 spare blades and two extra set screws. Sizes: .60, .80, 1.00, 1.20, 1.40, 1.60, 2.00, 2.50, and 3.00. Comes with rotating stand for easy access. Made in France.

Item No. **TL-27F** **\$59.95**

French 9 pc. Screwdriver Set

Premium quality color-coded screwdrivers includes a quality finished hardwood storage box, 19 spare blades and two extra set-screws. Sizes: .60, .80, 1.00, 1.20, 1.40, 1.60, 2.00, 2.50, 3.00mm. Made in France.



Item No. **TL-38F** **\$64.95**

Bergeon 9 pc. Screwdriver Set



High quality. Chromed & color coded screwdrivers. Sizes: .50, .60, .80, 1.00, 1.20, 1.40, 1.60, 2.00 and 2.50. Stable stand with adherent rubber padded bottom and center compartment with screw-on lid that holds 9 extra blades in sizes listed above.

Item No. **TL-27** **\$94.95**

Bergeon 10 pc. Screwdriver Set

High quality. Chromed & color coded screwdrivers. Sizes: .50, .60, .80, 1.00, 1.20, 1.40, 1.60, 2.00, 2.50 and 3.00mm. 20 (2 ea.) extra blades in the sizes listed above. Includes wood storage box.



Item No. **TL-38** **\$139.00**

9 pc. Replacement Blades

For set-screw type screwdrivers. 1 ea. of .60, .80, 1.00, 1.20, 1.40, 1.60, 2.00, 2.50, and 3.00mm

Item No. **TL-27B**
\$6.95

Bergeon Non-Magnetic Screwdriver Set



Chromed, 5 pc. assort. Blade sizes .50, .60, .80, 1.0 and 1.2mm with 1 spare blade per size.

Item No. **TL-39**
\$59.95

Spring Tension, Pick-up Screwdrivers



Jaws automatically adjust by spring tension to hold screws securely while removing or inserting. No more dropped or lost screws. Chrome handle.

1mm Flat Blade Item No. **TL-29** **\$22.50**
2mm Flat Blade Item No. **TL-30** **\$16.95**
2mm Phillips Blade Item No. **TL-31** **\$18.95**

Screwdriver Blade Sharpener

Insert the screwdriver blade shaft into the tool & tighten in place. Roll the sharpener over an Arkansas stone to sharpen blade. (Stone not included).



Item No. **TL-50** **\$4.95**

Saws and Files

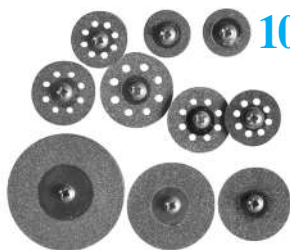

10 pc. Diamond Saw Set

Each saw has a mandrel with 1/8" shank. 200 grit surface. Sizes: 5/8", 3/4", 7/8", 1", 1-1/4" and 1-1/2" dia. Plastic storage box.

Item No. **TL-150-10** **\$18.95**

New 6 pc. Diamond Saw Set

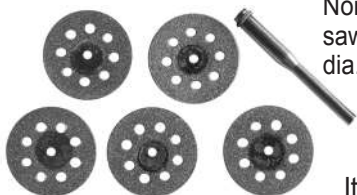

Non-clogging, 200 grit, diamond saws with mandrel. Overall wheel dia. 7/8". Arbor dia, 5/64".

Wheel thickness 1/64".
Mandrel shank dia. 1/8"

Item No. **TL-150-6** **\$8.95**



Saw Wheel

Stainless steel blade & arbor. Great for lathe, dremmel tool or drill. 22mm (7/8") dia. fine tooth blade. 1-3/8" long. 1/8" dia. mandrel.

Item No. **TL-147** **\$3.50**ea. 2 for **\$6.00**

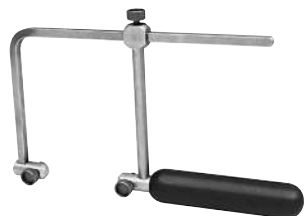

Swiss Saw Frame

High quality spring steel. Patented blade-lock design maintains perfect alignment & reduces blade breakage. 4" deep adjustable frame. Specially designed hand grip for better control.

Item No. **TL-109** **\$21.50**



Quality Saw Frame

Adjustable steel frame with thumbscrew locking devices for easy blade & tension adjustment, making it possible to use broken blades. Hard wood handle. 3" depth.

Item No. **TL-110** **\$11.95**

Jeweler's Saw Blades



5-1/4" long. In bundles of 12, one size per bundle.

Size	Teeth Per In.	Thick-ness	Width	Item No.
4/0	60	.0098"	.018"	TL-58-40
3/0	56	.010"	.019"	TL-58-30
2/0	52	.012"	.021"	TL-58-20
1/0	48	.0125"	.022"	TL-58-10
1	44	.0133"	.023"	TL-58-1
2	40	.014"	.027"	TL-58-2
3	36	.0149"	.031"	TL-58-3

\$2.50 12 pc. pk **\$7.95** gross

May mix sizes of saw blades to receive quantity discount

New 5 pc. Diamond File Set

7" long, 150 grit. 5mm. 5pc. Titanium coated diamond files set.

Item No. **TL-92-5** **\$14.95**



10 pc. Mini Diamond File Set

Grit 150-250
Set of mini 4" long files. Includes: Round, 1/2 round, flat, square, triangle & more with lasting quality of the diamond surface. Dipped handle.



Item No. **TL-93** **\$14.95**



Includes: Round, 1/2 round, oval, knife, diamond and square; plus course & fine of: flat ovals, flat rectangles and square triangles. Knurled handles for sure-grip in a pin vice. Plastic carrying pouches.

Mini Needle File Sets 4" long #2 files.
12 pcs. Item No. **TL-91** **\$7.95**

Economy 12 pc. File Set

5-1/2" long. Cut sizes 0, 2, 4.

Item No. **TL-94** **\$5.95**

3 pc. Diamond File Set

4" long titanium coated diamond files. 150 - 250 grit. Includes Equaling, Half Round, and Round styles.

Item No. **TL-90-3** **\$8.95**



Drills & Burrs

Carbon Steel Pivot Drills

Specially treated steel assures clean, rapid drilling. Perfectly centered and sized for extended life. 12 assorted drills in even sizes on a wood block.

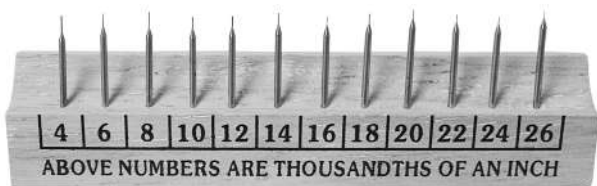

- Item No. **TL-117A** 3 ea. of .004" to .010" **\$46.95**
- Item No. **TL-117B** 1 ea. of .028" to .050" **\$47.95**
- Item No. **TL-117C** 1 ea. of .004" to .026" **\$47.95**

36 pc. High Speed Twist Drill Set

1 each of sizes 33, 36, 38, 40, 42, 44, 46, 48, 50, 52, 54 & 56 thru 79. Complete with numbered wooden stand.



Item No. **TL-111**
\$47.95

20 pc. English Twist Drill Set



High speed, high quality tempered steel by Dormer. 1 ea. of sizes 61 thru 80. Comes with numbered plastic container with see thru slide lid.

Item No. **TL-112** **\$34.95**

Economy Version

20 pc. HSS Steel from India. Item No. **TL-112E** **\$9.95**

20 pc. Drill Set

High speed twist drill set. 1 ea. of sizes 61 thru 80. Comes with a numbered round plastic holder with see-thru lid.

Item No. **TL-113** **\$23.95**



Pro-Cut

Compound extends the life of burrs, drills, gravers & sawblades. Lubricates to reduce friction & chatter.

Item No. **CP-04** **\$4.10**



20 pc. HSS Burr Set

Head sizes: 3mm to 6mm.
Shanks: 1-1/2" to 1-3/4". 1/8" dia..



Item No. **TL-130-20** **\$29.95**

New 30 pc. Diamond Burr Set

Head sizes: 1/16" to 1/2"
Shanks: 1/8" Grit: 240
Plastic storage case. Works on wood, ceramics, glass, tile, etc.



Item No. **TL-130-30** **\$12.95**

Drill Bits

Polished, high speed steel.



Size	Inches	mm	Item No.	Size	Inches	mm	Item No.
50	.0700"	1.7780	TL-59-50	66	.0330"	0.8382	TL-59-66
52	.0635"	1.6129	TL-59-52	68	.0310"	0.7874	TL-59-68
54	.0550"	1.3970	TL-59-54	70	.0280"	0.7112	TL-59-70
56	.0465"	1.1811	TL-59-56	72	.0250"	0.6350	TL-59-72
58	.0420"	1.0668	TL-59-58	74	.0225"	0.5715	TL-59-74
60	.0400"	1.0160	TL-59-60	76	.0200"	0.5080	TL-59-76
62	.0380"	0.9652	TL-59-62	78	.0160"	0.4064	TL-59-78
64	.0360"	0.9144	TL-59-64	80	.0135"	0.3429	TL-59-80

1 **89¢** ea. 10 **79¢** ea. 20 **69¢** ea. 30+ **65¢** ea.
May mix sizes to receive quantity discounts.

Drills with Pen Vice Holder



Drills are housed in plastic cylinder then store in handle of vice. Includes 12 American made drill bits in sizes: 52, 54, 56, 58, 60, 62, 64, 66, 68, 70, 72, 74. 3/8" dia. pin vice is rust free blue anodized aluminum with pocket clip, knurled handle & screw-on lid over storage area. Chuck can take drill sizes from #80 (.0135") to #52 (.0635").

Item No. **TL-115** **\$14.50**

New Tap & Die Set

14 taps and die in compact wooden box. Sizes (mm) .7, .8, .9, 1.0, 1.1, 1.2, 1.3, 1.4, 1.6, 1.7, 1.8, 1.9, 2.0.



Item No. **TL-154** **\$22.95**

Watch Tools

New Jaxa Jumbo Case Opener



Opens watch case backs from 19mm to 60mm. Comes with 12 pins to fit various cases.

Item No. **TL-155** **\$22.95**

Case Closer & Crystal Press

Now with chain link remover!



Great for snap-back watch cases from a small ladies to a large mens. A safe & easy way to mount bezel rings & inserting crystals. All metal body with angled leverage arm for safe & proper closure of cases. Comes with 14 two-sided dies for a total of 28 sizes, smoothed to a high polish so they will not scratch. Dies are both plastic and aluminum.

Item No. **TM-8** **\$36.95**

Economy Waterproof Case Opening Wrench

Good quality at a moderate price. All metal construction. Complete with 12 assorted pins. Packaged in a hardwood box.



Item No. **TL-77** **\$15.95**

Crystal Remover & Platform



For removal & installation of round unbreakable crystals from 8mm to 45 mm. Aluminum construction with brass fingers. Includes platform for gripping new crystals.

Item No. **TL-86** **\$19.95**

Multi-Purpose Link and Spring Bar Tool

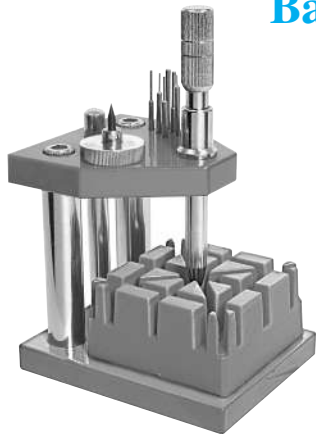

Excellent for removing friction fitted bracelet pins, Gucci & other types of bracelet screws. Synthetic block securely holds without scratching. Solid steel frame & tempered pin & blades. 12 pins, sizes (mm) .40, .60, .80, 1.00, 1.50 and 2.00. Screwdriver blade is 2.50mm.

Item No. **TL-153** **\$29.95**

Link Remover Holding Blocks

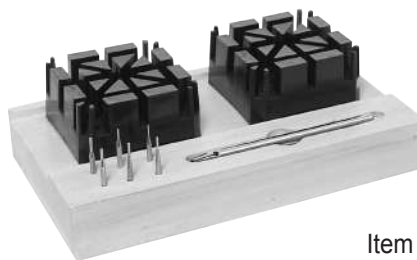

Synthetic blocks hold watch or bracelet for easy removal of pins. Set includes 2, 2" blocks, pin vise, 6 pins sizes .40mm to 2mm, and a wooden holding base.

Item No. **TL-84** **\$18.95**

Spring Bar Tools

5-3/8" Long

Item No. **TL-85-5**

\$5.95



For removal & installation of watch band holdings pins. All metal construction with knurled grips. Removable ends, 1 blade & 1 pin.

Mini Spring Bar Tool - 3" Long

Item No. **TL-85-3**

\$3.95



Link Pin Remover



For link type watch bracelets. Just place the bracelet on the device platform. Screw in the threaded pusher, pushing out the band pin 1/8", then remove the pin the rest of the way with pliers. Will not mar fine metals. Made of Keltec II (glass-filled nylon) with a hardened steel pusher pin. Complete with 2 extra spacers & 2 extra push pins to accommodate all bracelet thicknesses & instructions.

Link Pin Remover

Item No. **TL-83**

\$15.15

Replacement Pusher Pin

Item No. **TL-83A**

\$2.45

All prices are subject to change without notice.

Watch Tools

Case Closing Pliers



For closing snap-back cases where extra leverage is needed. All metal with rubber padded handles. Rubber-lined circular jaws eliminate scratching or breaking of crystals. 7-3/4" long.

Item No. TL-131 **\$15.95**

Clip Spring Removing Pliers

For Seiko Style Watch Bands



An essential tool for sizing watch bands. The flat jaw rests atop the link, the pointed tip fits under the clip spring. A gentle squeeze & the clip spring pops up. 5-1/2" long.

Item No. TL-132 **\$9.95**

Watch Strap Notching Pliers



Also known as "Gucci" pliers. For notching watch straps. Stainless steel, cuts up to 2mm wide. 5" long.

Item No. TL-133 **\$12.95**

Leather Punch Pliers



Stainless steel construction for a long life. Hardened center pin approx. 2mm dia. Great for leather and other soft materials. 5-1/4" long with return spring.

Item No. TL-135 **\$9.95**

Watch Winding Tool

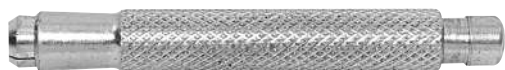

Push the end knob & jaws open to fit over stem. Knurled jaws hold the stem firmly. For watch stems 4mm dia. or larger. Nickel plated all metal construction with knurled hand grip. 3" long.

Item No. TL-139 **\$5.95**

Watch Movement Holders

12 plastic rings for holding pocket watch movements. From 7.5 to 22.5 ligne.

Item No. TL-152
\$3.95 set



New Swatch Battery Lid Opener



Opener has just the right tip to fit precisely into the battery cover on Swatch watches. Made of steel with a hardwood handle. 4" length.

Item No. TL-156 **\$5.45**

Handled Suction Case Opener

For waterproof & screw-back watch cases. Careful hand pressure & a jerky turn will open most cases. Rubber end knob will not mar soft metals. Wood handle with rubber end. 4-1/8" long. 15/16" dia.



Item No. TL-78 **\$4.95**

Rubber Vacuum Watch Case Opener

Double sided to fit watch sizes 0-18.2" dia.

Item No. TL-79 **\$3.50**



New Snappy Watch Case Opener

Item No. TL-157
\$11.95

The blade pops under the back making it easier to lift watch cases off.



Watch Case Opener

3" long.

Item No. TL-82 **\$2.95**



Order on-line. Visit our website:

ronellclock.com

For Orders Only
Call Toll Free

1-800-334-0135

Parts Rack with Drawers

Add some extra room to your work bench! Fits perfectly on the back of a bench or work table and has organized spaces for findings, tools, accessories, and more! A wonderful compliment to any work area.

- 4 Assort. small drawers
- 8 Slots for tools
- 48 Small holes for drills or burrs
- 1 Removable wood rod for small parts, jewelry, etc.
- 18" W x 7-1/2" H x 5" D

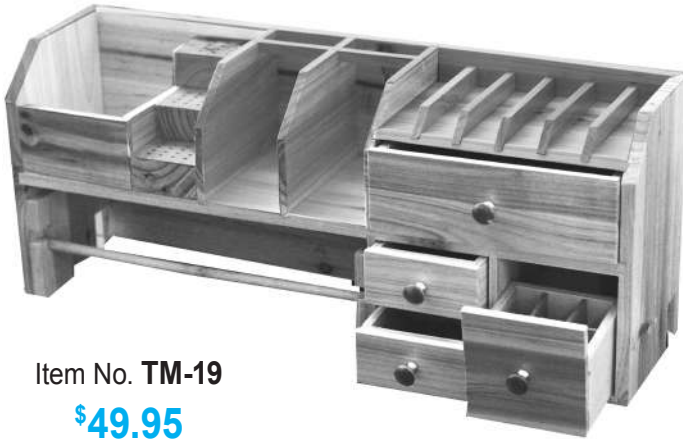

Item No. **TM-19**
\$49.95

New Parts Rack with Drawer

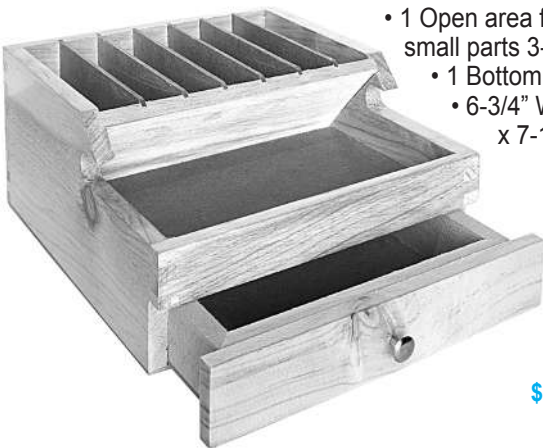

- 7 Slots for tools and pliers
- 1 Open area for tools or small parts 3-1/2" x 6"
- 1 Bottom drawer
- 6-3/4" W x 3-1/2" H x 7-1/2" D

Item No. **TM-20**

\$20.95

Extra Long Assembly Post

3-3/4" long for triple chime movements or grandfather movements.



1 Post
Set of 3

Item No. **TL-96**
Item No. **TL-96S**

\$7.25
\$20.95

Assembly Post Clamps

Holds movements for easy dismantling, repair, test running & reassembly. Posts are available in two sizes to allow clearance for the longest hand shaft. Brass clamp with steel screw leg. 2-1/2" post length.



1 Post

Item No. **TL-95** **\$5.00**

Set of 3

Item No. **TL-95S** **\$14.50**

Set of 4 w/hangers

Item No. **TL-97** **\$18.75**

Aluminum Regulating Stand

Sturdy construction, aircraft quality aluminum. Holding brackets adjust to fit any shape movement up to 14" high. Grooved brackets for square & rectangular movements & adjustable collars for round movements. 3 thumb screws for leveling the stand. 16-1/2" tall.



Item No. **TM-16**
\$51.95

Regulating Stand

Set-up, adjust & regulate a movement without having to put it back in the case. Heavy cast iron base with 2 leveling screws. Steel post & 2 grooved standard style holding brackets. Brackets adjust up to 11".



Item No. **TM-15**
\$48.95

Stand Accessories

No.	Jaw Width	Item No.
1	5/8"	TM-15-1
3	3"	TM-15-3
4	3-1/8"	TM-15-4
5	4-1/2"	TM-15-5

\$11.95ea.



Magnifiers & Accessories



OptiVISOR

Optical glass prismatic lens is bevel edged, ground & polished to precision standards. Adjustable pivots allow visor to be tilted. "Dial Adjustment" felt lined headband fits any head size. Tough & durable ABS construction. Made in USA.

No.	Focal Length	Magnification	Lens#
EV-01	20"	1-2X	2
EV-02	14"	1-3/4X	3
EV-03	10"	2X	4
EV-04	8"	2-1/2X	5
EV-05	6"	2-3/4X	7
EV-06	4"	3-1/2X	10

\$48.95 ea.

OptiVISOR Accessories

Visor Light



6000 Candle power, Xenon laser beam, hands free light. Clip-on installation. Light pivots to put beam where you need it. 5-6 hr. battery life (2 'AA' batteries, not included).

Item No. **EV-07** \$25.50

Optiloupe Attachment Lens



Fits on either side of the Optivisor. Adds an extra 2-1/2X magnification. Flips out of the way when not in use.

Item No. **EV-08** \$11.00

Replacement Lens



\$33.95 ea.

No.	Focal Length	Magnification	Len#
EV-09	20"	1-2X	2
EV-10	14"	1-3/4X	3
EV-11	10"	2X	4
EV-12	8"	2-1/2X	5
EV-13	6"	2-3/4X	7
EV-14	4"	3-1/2X	10

Snaps on & off, giving you a variety of magnifications on one visor.

Replacement Headband



Padded & felt lined for comfort. Easy "Dial Adjustment" for sizing. Fits all Optivisors.

Item No. **EV-15** \$16.95

Safety Goggles



Provides eye protection. Ventilated side shields & 1 pc. vinyl plastic lens. Elastic strap. Fits over eyeglasses.

Item No. **EG-01** \$3.75

Illuminated Hands-Free Dual Loupe Set

2 Sets of 4 interchangeable Acrylic lenses. 6X, 8X, 14X, & 17X. Loupes pivot & slide. Interchangeable elastic band option. Plastic loupe case. Super bright white LED. Requires 3 'AG10' batteries per loupe (not included).



Item No. **EV-18** \$19.95

Multi-PowerHead Illuminated Visor

2 configurations with 1 body: glasses or loupe. Loupe powers: 10X, 5X & 4X attachments. Glass powers: 1X, 1.5X, 2X, 2.5X, & 3.5X. Multi-coated Acrylic lenses. Head mount slides & tilts. Two flip-in lens attachments. Combine lenses for higher magnifications. Plastic body, elastic band, one size fits most. Super bright white LED and 2 plastic lens cases. Requires 3 'AAA' batteries (not included).



Item No. **EV-19** \$19.95

Illuminated Lens & Loupe Visor

2 lenses & 1 loupe. Fixed lens and flip lens 1.9X each, loupe 4.5X. 3-1/2" x 1-1/8" lens. 1-1/4" diameter loupe. Multi-coated Acrylic lens. Tilt & angle adjusting light beam controls, dial control adjustable head strap, plastic body. Comes with 2 White LED bulbs. Requires: 2 'AAA' batteries (not included).



Item No. **EV-20** \$12.95

Spectacle Loupes

Nickel plated

Single Item No. **EL-02**

1 - 3.3X lens \$6.95

Double Item No. **EL-03** \$7.95

2 - 3.3X lenses. Doubles to 6.6X

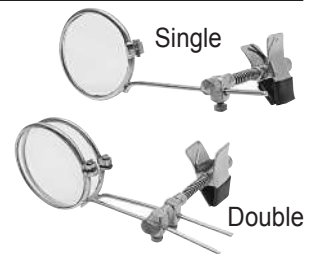

Safety Glasses

Aspen style, fits over most standard eyeglasses. Clear poly-carbonate lenses & side shields. Uvextreme coating is anti-fog, static, scratch & UV rays resistant.



Item No. **EG-02** \$9.35



Eye Glass Loupes

Clips onto eyeglasses.
Plastic loupe with metal clip.

\$3.95 ea.

Item No.	Focal Length
EL-10	2"
EL-11	3"
EL-12	4"

Aluminum Eye Loupes



Item No.	Focal Length
EL-13	1"
EL-14	1-1/2"
EL-15	2"
EL-16	2-1/2"
EL-17	3"
EL-18	3-1/2"
EL-19	4"

Designed to fit comfortably & reduce glare. Matte black interior.

\$2.95 ea.

Bausch & Lomb 4X Loupe



High quality carefully ground & polished glass lens for a clear, distortion-free image. 2-1/2" working distance. Feather-light frame with matte black interior.

Item No. **EL-20** **\$17.50**

4pc. Eye Loupe Set



Premium quality. 2.5X, 5X, 7.5X & 10X. Black plastic body with 25mm (1") diameter glass lens. With plastic storage container.

Item No. **EL-21** **\$5.95**

10X Triplet Loupe



21mm round. All metal body. Swing out lens. Complete with leather carrying case.

Item No. **EL-22** **\$18.50**

4pc. Aluminum Eye Loupe Set



Premium quality. Alluminum body with 22mm (7/8") diameter glass lens. Set includes 2.5X, 5X, 7.5X, 10X, and a plastic storage container.

Item No. **EL-26** **\$9.95**

Illuminated Tweezer with Magnifier



1" diameter glass lens. 7X magnification. Comes with one white LED bulb. Requires 3 AG7 batteries (included).

Item No. **EL-27** **\$9.95**

Double Eye Loupes



For extra small work. Remove the threaded upper portion for standard 2-1/2" focal distance. Black plastic for reduced glare.

Item No.	Magnification
EL-23	10X
EL-24	12X
EL-25	14X

\$3.95 ea.

2 for **\$6.00**

10X Eye Loupe

With Headband

Plastic loupe with black matte interior. Band is rubber coated for comfort.

Item No. **EL-28** **\$5.50**



New Helping Hand Illuminated Magnifier

Dual Power, 2X magnification with an additional 4X bifocal lens. Acrylic lens is 3-1/2" dia. magnifier. Clips, and joints all rotate 360° & tilt 180°. Cast iron base with soldering iron holder and recessed round dish holds sponge or small parts. Comes with 2 white LED bulbs. Requires 3 'AAA' batteries (not included).

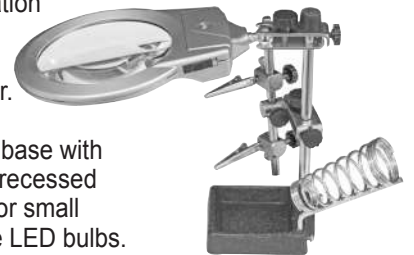

Item No. **EL-32** **\$16.95**

Telescoping Tools

Handy to have in the home, garage, office workshop, tool kit, etc. Useful for hobbyists of all types, not just clock repair. All metal construction with swivel bearings, adjusts to any angle. Convenient pocket clip.



Telescoping Alligator Clip #TL-140 **\$2.95**

Extends to 33".



Telescoping Magnet #TL-141 **\$2.95**

1-1/4lb. pick-up strength. Extends to 19".

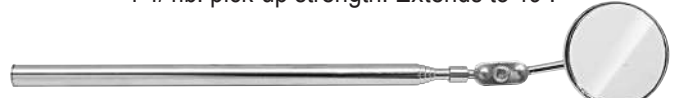

Telescoping Mirror #TL-142 **\$2.95**

1" dia. mirror. Extends to 24".

3 pc. Telescoping Tool Set

1 ea. Alligator Clip, Magnet & Mirror. Buy all 3 and save!

Item No. **TL-143** **\$7.95**

Soldering Supplies

Butane Micro Torch

Portable light weight, electronic ignition, 120 min. burn time, adjustable flame control. Max. temp. 2400°F. 6" tall with rubber cushioned safety grip & detachable base stand. Refillable 1.58fl. oz. (26 gr.) fuel tank. Butane not included. Factory guarantee, full instructions with diagrams.



Item No. **TL-08** **\$31.95**

Silver Solder

Paste. Low temperature. Works with just the heat of a lighter or match. No waste syringe. 7.1 grams.



Item No. **SD-10** **\$8.25**

Copper Solder

Paste. Low temperature. Works with just the heat of a lighter or match. No waste syringe. 7.1 grams.



Item No. **SD-11** **\$8.25**

Pewter & Pot Metal Solder

Corrosion resistant, color matching ability. Stronger than pot metal. Melts at 400° F. 7.1 grams.



Item No. **SD-12** **\$7.95**



Adjustable Temperature Soldering Iron

Temperature range from 392°F to 842°F. 110 volts, 60 watts. 3/16" pointed, tapered tip. 8 1/2" overall length.

Item No. **TM-13** **\$24.95**

1 lb. Stay-Brite Solder

High strength silver bearing solder melts & flows at 430°F. 3/64" diameter spool.



Item No. **SD-01** **\$74.95**

Stay-Brite Solder Kit

High strength silver bearing solder melts & flows at 430°F. Kit includes 1/2 oz. solder & 1/2 oz. flux.

Item No. **SD-02** **\$18.50**

Now 60W!



Electric Soldering Iron

8-1/2" overall length. UL quality. Thermally balanced for a longer life. Comes with a 3/4" long Nickel-plated copper tip. Tip is 1/8" diameter. Convenient non-rolling design keeps the iron in place. Comes with a soldering stand. 60 Watt.

Item No. **TM-14** **\$9.95**

Tix Solder

"Hardest soft solder on earth". Melts at 275°F, 4300 lbs. psi hold-ing power. Does not tarnish. 3" sticks.

Item No.	Weight	#Sticks	Price
SD-03-1	9 grams	20	\$13.75
SD-03-2	1 oz.	60	\$37.90

Tix Anti-Flux

Prevents solder from flowing to unwanted areas. Brushes on easily.

SD-04-1	1/2 oz.	\$4.00
SD-04-2	2 oz.	\$5.75

Tix Flux

Non-corrosive, water soluble, safe for hands & clothing. For soft solders.

SD-05-1	1/2 oz.	\$4.00
SD-05-2	2 oz.	\$5.75

New Ceramic Soldering Plate

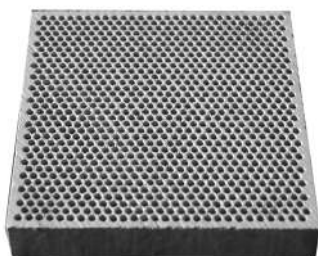

Alumina Ceramic Material. 4" x 4" x 20mm. Made of 30% Aluminum Oxide mix. Can be heated up to 2,200°F. 952 holes 2mm diameter.

Item No. **SD-06** **\$5.95**

Pro-Cut Lubricating Compound

Extends the life of burs, drills, gravers & sawblades. Reduces friction & chatter. Clean, easy to use. 2 oz.

Item No. **CP-04** **\$4.10**



Oilers, Greases, Sealants & Glues

Nye Oils



Help your timepiece perform at it's best. Resistant to temperature changes. Super refined to stay where it is put. Non-corrosive. Synthetic.

Clock

1 oz.	OL-02	\$9.95
2 oz.	OL-03	\$14.95
4 oz.	OL-04	\$19.95
8 oz.	OL-05	\$31.95
1 Pint	OL-06	\$49.95

Watch

1 oz.	OL-31	\$14.95
2 oz.	OL-32	\$27.95
4 oz.	OL-33	\$44.95

New Nye Pen Oiler with Clock Oil

With 3-1/4" blunt end needle. 5ml
OPO-06 **\$12.95**

Electric Grease

NyoGel-1 oz.	OL-51-1	\$5.95
NyoGel-2oz.	OL-51-2	\$8.95

Etsyntha Oils



859 Clock Oils

Synthetic stabilizers prevent aging under adverse conditions. Compatible with all metals and plastics. Resistant to laquers, stains, etc. Reduces friction and wear. Application temperature: -15°C to 100°C (+15°F to 212°F).

3.5 ml Bottle	OL-10	\$13.75	50 ml Bottle	OL-12	\$95.00
20 ml Bottle	OL-11	\$55.00	4 ml Pen Oiler	OL-13	\$20.50

2-1/2" long needle. Non-refillable.

Type 3-5 Oil

Newly formulated, partially synthetic clock and instrument oil with additives for high aging, oxidation stability and corrosion resistant performance. 14° F to 176° F working range. Excellent for small to large clocks & electric motors. (Replaces Type 5 Oil.)

30 ml Bottle	OL-14	\$25.50
100 ml Bottle	OL-15	\$73.00
8 ml Pen Oiler	OL-16	\$28.50

2-1/2" long needle. Non-refillable.

Oiling Kits

Includes: Pithwood cleaning block, metal 3-hole oil cup with lid, 2 flat tip needle oilers (1 fine, 1 med. point) and a glass wand for oil transfer from bottle to oil cup. Comes with plastic storage box.

#OL-17C Clock Kit with 3.5 ml #859 Clock Oil & 3.5 gr. B5-2 grease

#OL-17W Watch Kit with 3.5 ml each of Type 3-5 & Silber B Watch Oil

\$49.50 ea.

Silber Watch Oil

For fine wrist and pocket watches. Low spread rate and excellent pressure absorption. Formulated for jeweled bearings and precision parts. Application temp.: -25° to 80°C (-13°F to 176°).

3.5 ml	OL-35	\$27.00
5 ml	OL-36	\$37.00

B5-2 Grease

Very soft, semi-fluid consistency. High lubricating ability. Excellent for bearings, winding mechanisms, connecting pawls, ratchets, mainsprings and anchor pivots. Application temp.: -10°C to 80°C (14°F to 176°F).

7 gr.	OL-52	\$12.50
200 gr.	OL-53	\$85.95

Moebius Oils



Swiss made to the strictest quality standards. Long recognized as the best and most preferred by professionals throughout the world. Synthetic oil to prevent gumming, corrosion, acidifying or spreading.

Clock

20 ml #8030	OL-18	\$21.95
-------------	--------------	----------------

Quartz Oil

2 ml	OL-37	\$34.95
------	--------------	----------------

Tower

20 ml #8040	OL-19	\$21.95
-------------	--------------	----------------

Watch

Perfect for all watch mechanisms.
#8000
8 gr. **OL-38** **\$39.95**

Clock Spring Grease

A general purpose grease well suited to the winding and setting parts of watches. Also for uncoiled mansprings, as well as for clocks and clock springs. #8300

20 ml	OL-55	\$21.95
-------	--------------	----------------

Escapement Oil

Made to have a higher degree of oiliness for pallets.

2 ml	OL-20	\$31.95
------	--------------	----------------

Semi-Liquid Grease

For slow moving parts in clocks and watches with large friction areas.

#8200	OL-54	\$21.95
50 ml	OL-49	\$43.95



Dupont Clock Oils

High quality synthetic oil. Pointed cap for fine to high volume application.

Size	Regular		With Teflon	
	Item #	Price	Item #	Price
4 oz.	OL-21	\$5.95	OL-23	\$9.95
8 oz.	OL-22	\$10.95	OL-24	\$18.95

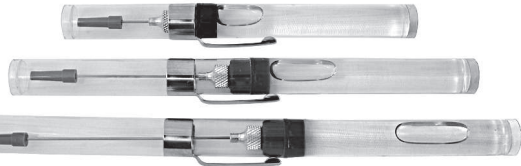

Dupont Pen Oilers

Filled with 5 ml. of top quality clock oil. Blunt end needle. Complete with protective needle, cap & cover with removable pocket clip.

Needle Length	Item No.	1	6	12	50+
1"	OPO-01	\$1.75	\$1.70	\$1.60	\$1.50
2-1/4"	OPO-02	\$1.85	\$1.80	\$1.70	\$1.60
3-1/4"	OPO-03	\$2.00	\$1.90	\$1.80	\$1.70

Dupont Teflon Oilers

Great for those hard-to-reach places. Filled with 5 ml. of top quality synthetic oil with Teflon. Completely waterproof. Temperature range -65° to 650°F. Blunt end 3-1/4" needles. Shake well before using.

Pen Oiler



Item No. OPO-04	\$3.10	\$2.90	\$2.65
------------------------	--------	--------	--------

Oil in 1/2 oz. Refillable Bottle



Item No. OPO-05	\$4.10	\$3.90	\$3.65
------------------------	--------	--------	--------



Micro-Lube 2 Stem & Winding Gear Lubricant

For small gear trains in watches, clocks and instruments. Will not ball up, run, break down, or gum up. Flexible hypodermic applicator is ideal where precision lubrication is critical. 5cc tube.

Item No. **OL-64** **\$8.50**



Keystone Clock & Instrument Oil

High quality oil great for all clocks and mechanical instruments. Remains in place, resists gumming and prevents oxidation.

2 oz. Item No. **OL-27** **\$6.50**



The System #163 Clock Oil

This synthetic lubricant does not spread, gum or oxidize.

1/4 oz. Item No. **OL-25** **\$11.95**



The System #32 Grease

Synthetic for mainsprings and other sliding parts.

1 oz. Item No. **OL-66** **\$11.50**

Mainspring Grease

OL-62

High quality in an accordion style plastic dispenser. 1-1/2" long steel needle with cap. 1 oz.

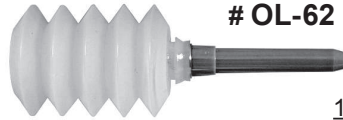

1	3	6	12+
\$2.00	\$1.90	\$1.85	\$1.80



B & K Mainspring Lube

High quality lube, proven to last for over 10 years! Stays in place even under extreme pressure to stop binding and wearing, extending the life of the mainspring. Repels moisture to stop rust and oxidation. Won't contaminate movements.

Light Grade

For alarm, small clock & pocket watch movements.

4 oz. # OL-56	\$7.25
8 oz. # OL-57	\$10.25

Medium Grade

For wall, mantle and floor clocks.

4 oz. # OL-58	\$7.25
8 oz. # OL-59	\$10.25



Keystone Mainspring Lube

Excellent film strength allows smooth and even release of mainsprings. Super adherence to prevent binding, metal fatigue, rusting and oxidation.

No sulphur or graphite to contaminate movements. Displaces moisture. 8 oz. bottle.

Light Grade #OL-61

For alarm, small clock & pocket watch movements.

Medium Grade #OL-60

For wall, mantle and floor clocks.

\$8.50ea.

New Spc. Oil Cups & Oilers

Includes 4 color-coded oil cups and 4 pin oilers all in a convenient 5-1/2"W x 2-1/4"D wooden stand. Oil cups are 1-1/8" diameter with center recess diameters of: Black 8mm, Blue 9mm, Green 14mm, Red 17mm. Pin oiler needles are 1/2" long with wire gauges of: Black .20mm, Blue .30mm, Green .40mm, Red .50mm.

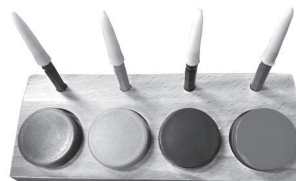

Item No. **OL-99**

\$12.95

Hypodermic Oil Applicator

Extra Fine, 2-1/4" Needle, Blunt End



Designed for precision work. The finest gauge needle on the market. 2 ml capacity plastic tube. Extra long 2-1/4" blunt-end needle for those hard-to-reach places. Needle end cap included.

Extra Fine .009 gauge Item No. **OL-94**
Fine .013 gauge Item No. **OL-93**

\$2.00 ea. 6 for **\$10.50** 12 for **\$18.00**

Dip Oilers with Caps



Economy .30mm Tip Item # **OL-95** **\$2.00**
Economy .75mm Tip Item # **OL-96** **\$2.00**
Set of 5 Steel Tips Item # **OL-97** **\$10.25**

Sizes: Red .20mm, Blue .22mm, Black.30mm, Yellow.40mm, Green .50mm

Empty Refillable Bottle

1/2 oz. plastic container, 3-1/4" blunt-end needle with protective cap. **Oil Not Included.**



Item # **OL-90** **\$2.25** ea. 6 for **\$2.00** ea.

Oil Extension Tube

Sold Separately

For use on pen oilers or hypodermic oilers where extra length is needed or hard-to-reach areas. 8" long.



Item No. **OL-91** **\$1.00**

Deluxe 3-in-1 Oil Cup



3 glass oil cups with swing back lid, 3 protective needle holder holes & 2 recessed slots for holding oilers. Heavy metal construction with non-skid rubber base. 2-1/4" w x 1-3/4" d x 1-1/8" h.

Item No. **OL-100** **\$17.50**

Vigor Jewelers Epoxy

Sets in 4 minutes, clear & colorless. Bonds plastic, metal, wood, glass, etc. 2 part mix. 1 fl. oz.



Item No. **CP-14** **\$4.60**

Vigor Super Glue

Sets in 45-60 sec. High strength, rapid bonding. 7 fl. oz. (20 gm)



Item No. **CP-15** **\$8.95**

UV Glue

Clear crystal adhesive that cures under ultraviolet light or direct sunlight. Special tip for precise application. .7 fl. oz.

Item No. **CP-03** **\$7.65**

Extra Tip

Item No. **CP-03T** **\$1.10**



Metal Patch & Fill Compound



For use on all metals. Seals, fills and bonds. Rustproof. Build up worn surfaces. Resistant to oil, water, gasoline and most chemicals. Can be drilled, sanded or painted. Cures to a gray finish.

3 oz. Tube

Item No. **CP-07**
\$5.00

Zenith Vacu-Seal



Seals all waterproof watch cases, crowns, crystals, tubes and case backs. 1 fl. oz.

Item No. **CP-01**
\$7.50

G-S Crystal Cement

Item No. **CP-02**
\$5.75



For glass or plastic crystals, crafts, etc. Precision needle applicator tip. Will not flake or crack plastic. 1 ft. oz.

Oil Cup



3 reservoir. Plastic with lid. 2" diameter.

Item No. **OL-92** **\$2.50**

Ronell Cleaning & Rinse Solutions

Clock Cleaning Concentrate Ammoniated



Maximum cleaning power for manual or ultrasonic tanks. 10 to 1 mix ratio (other leading brands are only 8 to 1). Water base, non-flammable, non-hazardous, brightens brass. Can adjust strength for strong or mild cleaning. No hazard fee. 1 gallon.

Item No. **SOL-100A**

\$31.95 per 4 gal. case **\$29.95** gal.

Clock Cleaning Concentrate Non-Ammoniated



Maximum cleaning power for manual or ultrasonic tanks. Water base, 10 to 1 formula. Contains brass brighteners, is gentle on lacquer and great for use in unventilated work areas. Non-hazardous, no-flammable. 1 gallon.

Item No. **SOL-100N**

\$31.95 per 4 gal. case **\$29.95** gal.

Watch & Clock Rinse Extra Fine



Ready to use. Made from a clear petroleum distillate for a clear, clean, no oily film rinse. Water droplets disperse off parts and bead in the bottom of the tank helping to prevent rust & pitting. Quick drying. For ultrasonic or manual use. Contains no benzol or chlorinated solvents. No hazard fee. 1 gallon.

Item No. **SOL-200**

\$32.95 per 4 gal. case **\$30.95** gal.

#688 Waterless Clock Cleaner

Non-Ammoniated

Ready to use. Maximum cleaning power in a solvent base, non-ammoniated formula for unventilated work areas. Brass brighteners, tough on dirt & oils. Will remove lacquer. For manual or ultrasonic tanks. No hazard fee. 1 gallon.

Item No. **SOL-688**

\$35.95 per 4 gal. case **\$33.95** gal.



Specialty Cleaners

Ronell Hairspring Cleaner



Hairspring cleaner, non flammable, degreaser, fast cleaning, dries almost instantly, neutralizes acids, inhibits rust.

8 oz. Item No. **SOL-09** **\$11.50**

16 oz. Item No. **SOL-10** **\$16.95**

12 oz. spray Item No. **SOL-11** **\$17.95**

Ronell Super Clean Sprays



Highest purity solutions, leaves no residue, rapid dry, no chlorinated solvents. Quickly flushes away grease, oil dirt & dust. For those who don't want to disassemble gear trains. 13 oz.

Super Clock Clean

Item No. **SOL-90**

\$13.95 ea. 2+ **\$13.50** ea.

Super Watch Clean

Item No. **SOL-91**



SiliKroil Loosens Frozen Metal



A penetrating solvency oil to free frozen metal parts due to rust, oxidation or corrosion. Dissolves grease & carbon while lubricating with silicone. Great for use on clock movements, cars, screws, nuts & bolts, gears, joints, many types of machinery, etc.

4 oz. Item No. **SOL-01** **\$5.95**

8 oz. Item No. **SOL-02** **\$8.95**

PlastiClean II



The high power spray safely & quickly dissolves oil, grease, resins & foreign particles from plastic & metal watch or clock movements. No need for disassembly. Just spray on, let stand 4-8 sec. then blow off using compressed air. 13 oz. Aerosol can.

Item No. **SOL-08** **\$18.95**

X-Rust Superior Rust Remover

Just apply X-Rust, let stand for 1/2 to 3 hrs. according to the depth of rust. X-Rust combines with the rust to leave a grey surface. Rinse with clear water & the surface is ready to receive any type of coating, plating, soldering or welding without further treatment.

4 oz. Item No. **SOL-03** **\$5.95**

8 oz. Item No. **SOL-04** **\$8.95**



Dust-Off Compressed Gas duster

Blasts dust & dirt from hard to reach places without harming delicate instruments or surfaces. Leaves no residue. Great for clocks, craftsmen & technicians. 12 oz. aerosol.

Item No. **SOL-07** **\$8.95**



Cleaning, Polishing and Repairs

Pro-Craft Compound Set

Peel-back tubes eliminates mess & broken bars. Set of 5. 4 oz. to 5 oz. tubes.



Red Rouge: for final color lustre on soft metals.

Yellow Rouge: For hard metals: platinum, chrome & stainless steel. Leaves little residue on work.

Tripoli: Fine cutting abrasive for all metals. Leaves metals scratch-free but dull. Use rouge for final finish.

Plastic Compound: For polishing hard plastics only.

Emery: Use on iron, steel & hard metals for coarse buffing to remove scratches, rust, burrs, etc.

Item No. **CP-05**

\$17.00

Polishing Rouges

1-3/4" W X 2-7/8" L X 1" thick



Black: gives a rich antiqued look to white, gold, silver and platinum.

Item No. **CP-12** **\$4.25**

Red: for a final high luster on soft metals, gold, silver, brass, etc.

Item No. **CP-13** **\$4.25**



Euro Lustre Cut and Polish Compound

Special formula removes light scratches and produces a mirror finish with no discoloration. Use on all types of precious metals, brass and pewter. Greaseless, easy clean-up with little or no residue. 1lb. tube.

Item No. **CP-16** **\$7.25**



Nev-Dull Wadding Polish

Removes rust and corrosion instantly. Excellent for silver, gold, brass, copper, pewter, steel, aluminum, and chromium. Leaves no deposits in cracks. 5 oz.

Item No. **CP-17** **\$7.50**

7" Shellac Stick



For setting small stones and jewels in pallets. Heat to apply. Item No. **CP-08** **\$11.85**

Rodico Cleaning Stick



Item No. **CP-10** **\$4.75**

Clean precision parts, remove finger prints & stains, excess oil, grime & grease. Great for removing broken watch parts.

New 12pc. Furniture Repair System



Includes: 6 filler sticks for filling gouges and deeper repairs. 6 repair markers for instant repairs and worn areas.

Item No. **CP-19**

\$9.95

Crystal Bright Plastic Restorer

Gently buff old plastic crystals to remove scratches. Charge your buffing wheel with a small amount of compound or use on a polishing cloth. For minor scratches. 3 oz.



Item No. **CP-11** **\$3.95**

New "Brilliant" Polishing Cloth

Treated with a newly developed chemical agent which cuts through tarnish better than other cloths and inhibits tarnish from reappearing. Work on brass, chrome, copper, silver, and gold without getting rouge on your hands! 12" x 15".



Item No. **UA-16** **\$5.75**

Selvyt Polishing Cloth

English made. Washable, will not scratch precious metals. 14" x 14".



Item No. **UA-08** **\$12.50**

Fabulustre Polishing Cloth

2 pc. cloth puts a bright shine on silver, gold, brass, etc. The inner cloth is impregnated with professional jewelers rouge. Cleans and shines like magic. 10" x 10"



Item No. **UA-09** **\$5.70**

Flitz Metal Polish



50 gram tube

Anti-tarnish formula. Works well on metal, plastic and fiberglass.

Item No. **CP-06**

\$14.95

Small Parts Cleaning Baskets & Accessories

Small Parts Basket

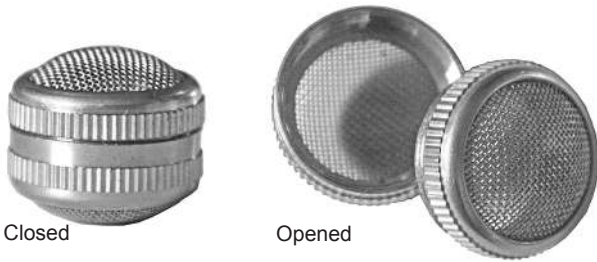

7/8" (23mm) diameter. Brass body with stainless steel wire basket. Can be used in ultrasonic machines to clean small parts, diamonds and jewelry.

Item No. **UB-11** \$4.95

Wash Cup with Beaker



Heavy duty glass jar with plastic screw-on lid. Perforated stainless steel beaker suspends from lip of jar. Or can be used in any container or solution. Jar: 2-1/2" dia x 2-5/8"H. Beaker: 1-1/2" dia x 2" high. 35" cu. capacity.

Item No. **UB-06** \$10.95

Plastic Cleaning Tray



Perforated bottom. Great when washing in shallow containers. Size 2-1/8" diameter x 3" high.

Item No. **UB-07** \$2.50

4 Pc. Funnel Set



Sizes 50, 75, 100, 120mm. Plastic. Oil & acid resistant.

Item No. **UB-10** \$3.95

Economy Dust Blower



Great for blowing away dust, shavings, foreign particles, etc. Specially equipped valved tip shoots a strong stream of air right where you need it. Metal tip.

Item No. **UA-14** \$3.95

Stainless Steel Baskets

Heavy duty! Safe in any container or solution. Sides and bottom are perforated with hundreds of tiny holes to let solution in but not let parts out.



Small
Item No. **UB-04** \$5.95

Small
1-1/2" dia.
2" high
3.5" cu. cap.

Large
Item No. **UB-05** \$12.95

Large
2-5/8" dia.
3-1/2" high
19" cu. cap.

Mini Cleaning Basket

Very fine mesh basket keeps even the smallest parts safe while cleaning. Spring handle keeps basket closed. Stainless steel. Safe in any solution. 6" long. 2-1/2" dia. basket.



Item No. **UB-03**
\$3.95

Hanging Racks

Chemical & abrasion resistant, poly-coated wire racks. Suspends from sides of ultrasonic tank or cleaning container.

Limited Inventory!

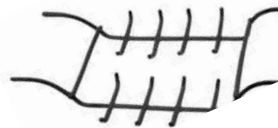

Single Rack

Item No. **UB-08** \$3.00
16pc. cap. 4-1/4"W x 8"L



Double Rack

Item No. **UB-09** \$8.95
80pc. cap. 4-1/2"W x 12-3/4"L

Denim Apron



Heavy duty blue denim. Breast pocket with pen holder. Comes with 4 comfortable cloth straps for tying the neck loop & sides. Machine finished edges for long life. Washable. 27"W x 36"L.

Item No. **UA-13**
\$6.95

Bergeon Dust Blower



Long life rubber blower is great for blowing away dust, shavings, foreign particles, etc. The PVC valved tip shoots a strong stream of air right where you need it but blocks foreign particles from being sucked into the nozzle.

Item No. **UA-15** \$12.95

Cleaning, Sanding & Polishing Accessories

Hard Arkansas Stone

Used in polishing pivots and sharpening gravers.

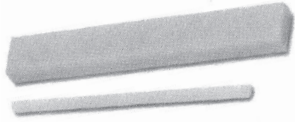

Square, 2 1/2" x 1/8"

TL-73-1 **\$11.95**

Beveled, 3" x 3/8" x 1/8"

TL-73-2 **\$23.95**

India Stones

Used in polishing pivots and smoothing work.



Square, 4" x 1/4"

TL-72-1 **\$6.50**

Knife, 4" x 1"

TL-72-2 **\$11.95**

Pithwood



Item No. **UA-10**

\$5.50

12 piece, Assorted diameters. For cleaning pinions, pivots, oilers, tweezers, etc. or for holding small parts like pallet forks, train wheels, etc. while cleaning. Can also be used to make verge or escape teeth impressions.

Pithwood Sticks



Item No. **UA-11**

\$3.95

5 piece, 4" long assorted diameters. For cleaning, holding & impressions (see Pithwood above). Cut your own to the thickness you need. Buy in bulk for economy & convenience. Approx. yield is 40 pcs. 1/2" thick.



Nitri-Solve Gloves

Provides excellent protection against a broad range of solvents. Abrasion, puncture & cut resistant. 15 Mil., 13" long. Non-Slip grip.

Item No. **UG-02**

\$3.95 Pair



Heavy Weight Cotton Gloves

Great for dusting, polishing & buffing. Keeps hand smudges & finger prints off of glass and shiny metals. Good quality for long life. Will stretch to fit any hand size. Washable.

Item No. **UG-03**

6 Pairs **\$7.50**



Cotton Gloves

Keep hand smudges & finger prints off of glass & shiny metals such as weight shells. Lightweight, bleached, jersey cotton material has strong, tight weave & is chlorine free. Reversible to fit either hand. 12 pairs per pack.

Item No. **UG-04** Small to Med. **\$7.95**

Item No. **UG-05** Large **\$11.95**



Pegwood

Orange wood. Approximately 24 sticks to a bundle. Size: 3.25mm dia., 8" long.

Item No. **UA-12**

\$5.25

Emery Buffs

3/4"W x 9"L

Grit	Item No.	Grit	Item No.
6/0	TL-148-60	1	TL-148-1
5/0	TL-148-50	2	TL-148-2
4/0	TL-148-40	3	TL-148-3
3/0	TL-148-30	4	TL-148-4
2/0	TL-148-20	5	TL-148-5
		6	TL-148-6

\$1.20 ea. 6+ **\$1.00** ea.

Black Leather Emery Buff

3/4"W x 9"L



Item No. **TL-148L**

\$1.95

Order On-line. Visit our Website

ronellclock.com

For Orders Only
Call Toll Free

1-800-334-0135

Mail in Orders:

Ronell Clock Co., P.O. Box 5510, Grants Pass, OR 97527

Bufs & Brushes



Dixcel Scratch Wheels

Wire bristles are mounted on seasoned hardwood hubs with metal reinforced center holes to fit tapered spindles. 1/4" arbor holes.

Brass Wheels

Two styles to choose from:

Straight brass wire (.003" strands) creates a coarse finish for cleaning and surface finishing of brass and other metals.

Crimped brass wire (.004" strands) creates a softer, satin or matte finish for surface finishing of yellow metals.

Item No.	Diam.	Rows	Style	Price Ea.
BR-13	3"	2	Straight	\$11.00
BR-14	4"	3	Straight	\$17.90
BR-15	3"	2	Crimped	\$6.75

Steel Wheels

Clean, debur & surface finish silver, aluminum & other white metals. .003" strands. Lightly crimped.

Item No.	Diam.	Rows	Price Ea.
BR-06	3"	3	\$10.00
BR-07	4"	3	\$12.50
BR-08	3"	4	\$11.50

New

"Brilliant" Buff



Made of 100% long strand Egyptian cotton, impregnated with an environmentally safe chemical that leaves a light residue to inhibit tarnish. Excellent for final buffing, then wipe with a dry cloth for a beautiful luster. Buff has a small hole for tapered spindles. 4-1/2" dia., 3/4" thick.

Item No. **BR-05** **\$11.95**



3 Pc. Toothbrush Set

Item No. **BR-17** **\$3.95**

1 Each of stainless steel, brass & nylon. Brush heads are 1-1/2" L x 3/8" W with 5-1/8" plastic handles.



Dial & Detail Cleaning Brush

3/4" W x 1-1/8" L nylon bristles. Plastic handle. 4-1/2" overall.

Item No. **BR-18** **\$2.95**

124



Dixcel Cotton Flannel Buffs

Used with rouge for buffing. Made of soft cotton flannel with total weave dispersion for longer buff life. Stitched and shellac hardened centers.

Item No.	Diam.	Ply	Stitching	Price-
BR-10	3"	30	3 rows	\$2.90
BR-11	4"	30	3 rows	\$3.65
BR-12	5"	30	3 rows	\$4.65



Brass Tube Brushes

Item No.	Brush Diam.	Wire Diam.	Overall Length	Price
BR-20	1/8"	.003	6"	\$2.95
BR-21	3/16"	.003	7"	\$3.10
BR-22	3/8"	.004	8"	\$3.25

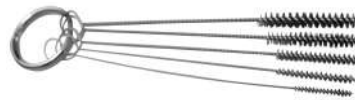

5 Pc. Tube Brush Set

Nylon Brush Sizes (dia. x length): 1/16" x 9/16", 3/32" x 7/8", 1/8" x 1", 5/32" x 1-1/8", 7/32" x 1-3/8". Brass Brush Sizes (dia. x length): 5/32" x 1", 3/16" x 1", 7/32" x 1", 1/4" x 1", 9/32" x 1". All are 3-7/8" overall length. Complete with handy key ring.

BR-26N Nylon **\$4.95** **BR-26B** Brass **\$6.50**

German Quality Scratch Brushes



4-1/2" pen-shaped handle. Metal ferrules for durability.

Item No.	Bristle Type	Price
BR-27	Fiberglass	\$7.50 ea.
BR-28	Brass	

New 3pc. Scratch Brush Set



Includes 1 ea. Fibre Glass, Brass, and Steel Brushes.

Item No. **BR-31** **\$7.95**



Refills for Scratch Brushes

Item No.	Bristle Type	Refills are 1-1/4" long
BR-29	Fiberglass	\$1.50
BR-30	Brass	\$2.00

BOOKS FOR: Clock Making and Repair

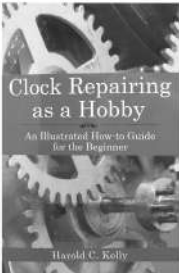

Clock Repairing As a Hobby

By Harold C. Kelly

A How-To Guide for the beginner. Written by a professional author with years of experience both teaching & as the repairman for a major jewelry store. Excellent black & white

diagrams & pictures. Chapters include: The Clock Movement; Escapement for Pendulum Clocks; Escapements for Balance Wheel Clocks; Pendulums; Striking Mechanisms; Tools, Materials & Supplies; Repairing The American Striking Clock; Repairing The 400-Day Clock; Repairing American Alarm Clocks; Special Repair Techniques, plus a list of tool & material dealers & a list of other good source books & magazines. 122 Pgs. 6x8-1/2"

BK-100 Soft Cover **\$9.95**



The Clock Repair Primer

By Phillip Balcomb

A Beginner's Intro to the Mechanics of Pendulum Clocks & Basic Clock Repair. Simple, understandable, step-by-step instructions & diagrams. Outline form for easy reference. Chapters:

Hands-repair, malfunction, etc.; Dials-designs, bezels, problems, cleaning, etc.; Pendulums-types, bob types, etc.; Pendulum suspension devices; Movement examination & problem correction; Tools & how to use them; Removing; Striking mvmts-count strike, chiming, time train, rack & snail, mechanics, wheels, etc. Weight & spring movement disassembly, cleaning & reassembly; Repair of bushings, clicks, pivots, fly fan, etc. Plus Bibliography & Clock Parts Suppliers List. 140 Diagrams 151 Pgs. 8-1/2x11"

BK-101 Soft Cover **\$16.95**



Clock Repair Basics

By Steven Conover

A repair course in itself by an author with many years of experience. Takes you step-by-step from start to finish. Topics cover

Disassembly; Cleaning; Mainspring let-down, length calculation & replacement; Pivots & bushing techniques & special cutters; Escapement adjustment & repair. Gear train counting for beats per hour: Calculating pendulum length; Beginner's guide to strike & chime mechanisms, Lubrication guide; Electronic clocks; Beat setting; 5 "Starter" clocks - OG, American striker, cuckoo.

400-day, & Hermle chime. Equipment & tool list; Glossary of clock terms; Clock parts source list; 168 excellent, close-up black & white photos, diagrams & charts. 92 Pgs. 9x11"

BK-102 Soft Cover **\$22.95**



Clock Repair Tips

For the Hermle 340-320 Mvmt.

By Bill Tipton

With all the 340-020 Hermle mvmts. on the market & with increasing prices for a new mvmt., it is invaluable to have a simple & detailed repair guide. 37 detailed

drawings with precise explanations. Chapters: Mvmt. inspection, disassembly, cleaning, re-assembly, test prep., lubrication, 8-Day test, trouble-shooting; Balance unit - cleaning the Helical & Flat Spring style; HSS & FSS balance units; Replacing the HSS support wire. Ultrasonic cleaning., hearing the beat, repair of small broken parts & bushing tips. Special sections include: Table of wheel rotation, chime & strike sequence, supply houses, chime sequences, letting down mainspring in barrels, exposed loop end mainspr., use of a mainspr. winder, removal & installation of a hole end mainspr. from the barrel, removal & installation of a clamp captured loop end mainspr. from its arbor. Info for 340-020 & chiming mantle mvmt. Glossary of terms. 120 Pages. 9" x 11".

BK-103 Soft Cover **\$34.95**



The Clock Repairer's Handbook

By Laurie Penman

Back by popular demand! Everything you need to know to diagnose & repair both antique & modern clocks.

Written by a trained mechanical engineer & clock repair teacher. Good tips for beginners with 250 drawings & diagrams. Chapters include: Finding clock faults; Cleaning clock movements; Bushing clock plates; Pivoting & mounting; Anchor escapements; Deadbeat escapements: Verge Escapements; Train faults & gears; Suspensions & crutches; Strike & chime work; Lubrication & friction; Weight & spring drives; Tools & equipment. Plus a detailed glossary of terms, supplies list & reading sources. 176 Pgs. 7x10"

BK-104 Soft Cover **\$17.95**



Clock Repair Skills

by Steven Conover

Easy-to-use follow-up volume to the authors 'Clock Repair Basics'. Techniques for learning intermediate level clock repair presented with 225 black &

white photos & drawings. Topics include: Repivot an arbor (lathe work); Lantern pinion repair (trundles); Tooth replacement - one or several; Repair 2 recoil escapements (resurfacing, analization, adjustments, strip pallet work); Make bushings; Bushing a barrel; American main wheels (reversal, replacement, repair); Bell strike main wheels (wobbling & click repair); Grandfather chain wheels (repivoting & clickspring); Make a rack & snail; Repair a moon dial; Making & repairing hands (silver solder, bluing, brass work); Using a depthing tool. Plus extensive index for quick reference. 92 Pgs. 9x11"

BK-105 Soft Cover **\$24.95**



New Repairs Book One

By Steven G. Conover

Clockmakers Newsletter Workshop Series.

For the first time, you can read articles on clock repair techniques, immediately followed by the viewpoints of

clock repair writers, clock shop "pros", and experienced repairers. The author edits the 256 issues of his Clockmakers Newsletter into workshop manuals, reorganized by subject. Topics include cleaning, oiling, assembly, pivot polishing, lantern pinion repair, soldering techniques, troubleshooting, and setting up a workshop. Bushings and Mainsprings each have their own chapter! Plenty of interesting, informative material for everyone, from the beginner to the seasoned repairer. Featuring over 150 pictures and drawings. 190 Pgs. 9" x 11"

BK-106 Soft Cover **\$37.95**

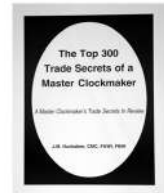

The Top 300 Trade Secrets of a Master Clockmaker

By J. M. Huckabee

The author with over 50 yrs. of experience, covers the more difficult jobs that would normally

be sent to 'specialty shops' in the restoration of older American clocks. Given in excellent detail for easy understanding by beginners & experienced repairmen. Over 300 black & white illustrations. Topics covered are: Tools; New pivots; Bearing problems on the winding arbor; Inspection; Great wheel problems; Strike train components & problems; Bad & bent pivots, arbors & pinions, tools & methods; Bushing bad pivot holes & related problems; Making bushings; Dial replacement; Escape wheel problems; Wheel assembly techniques; Click & assoc. problems; Magnetized tools & parts. Screw & hand nut making; Lathes & tool bit grinding; Hand problems; Suspension spring & pendulums; Time train ratio study. 111 Pgs. 8-1/2" x 11"

BK-107 Soft Cover **\$22.50**

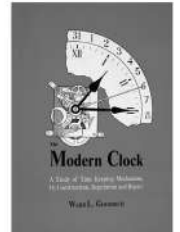

The Modern Clock

By Ward Goodrich

"A Study of The Time Keeping Mechanism; It's Construction, Regulation & Repair." For the hobbyist to advanced. Chapters: Clean, Repair Cuckoos; Clock Case Repairs; Compensating Pendulums; Construction & Repair of Dials & Mercurial Pendulums; Construction of Simple/Perpetual Calendars: Cylinder, Dennison/Gravity, Detached Lever. Dead Beat, Le Paunte, & Recoil/Anchor Escapements. Elect Clocks & Batteries; Hammers, Gongs & Bells; Motion Work & Striking Trains; Natural Laws Governing Pendulums; Angular Measurement; Plates. Pivots & Time Trains; Regulations, Suspensions, Crutches & Minor Points; Snail Striking Work English, French, Amer.; Making a Regulator; Springs, Weights & Power; 400-Day Clocks. 502 Pgs. 6"x9"

BK-108 Hard Cover **\$27.50**

BOOKS FOR: Clock Repair for Specific Types of Clocks A-Z

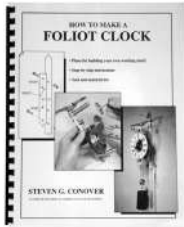

How to Make a Foliot Clock

by Steven Conover

Complete plans by a master clockmaker for building your own working clock! Based on the American Columbus Clock of the

1890s. Step-by-step instructions, tool & material list. There are 86 B&W pictures & diagrams. Contents include: Specifications & authors notes, tools & materials, plates & pillars, the wheels, main arbor & wheel collet, the pinions, making & fitting the 2nd & escape arbors, the motion work, the escapement, power, dial & hand work, finishing touches, index & sources. 88 Pgs. 9" x 11"

BK-109 Soft Cover **\$23.95**



How to Repair 20 American Clocks

by Steven Conover

Covers 20 of the most popular movements used in 100's of clocks from the 1800 & early 1900's. Repair topics cover the case, dial, hands

& movement. Learn to repair their escapements, winding mechanisms, strike trains & much more. Over 246 black & white photos & detailed diagrams to make repair easy. Movements covered include: Ansonia Belmont & La Normandie; Gilbert Amboy; Ingraham Amulet & Domino; New Haven #95 & Harmonius; Poole Partician & Executive Model 5; Sessions Regulator #2 & Credo; Seth Thomas Salem Cottage. Athens. Cluny & Sharon; Waterbury Cottage. Canton & Antrim; E.N. Welch OG; Welch, Spring & Co. Italian #3 & Patti. Plus a complete detailed index & Mainspring size list for each clock. 140 Pgs. 9" x 11"

BK-110 Soft Cover **\$28.95**

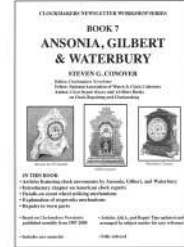

New Ansonia, Gilbert & Waterbury Book 7

By Steven Conover

Chapters include - General Repair: Tension springs, understanding counterwheel strike mech. & assembly; Ansonia kitchen, iron cased, & swing arm clock repair; Gilbert assembly of count wheel mvts. striking issues; Bellwood chime, novelties, gear & mainspring issues, triple plates & more; Waterbury Angelus Strike, OG, Antrim Shelf, Cottage, Regulator repairs. Plus, arbor replacement work, clicksprings, pendulums, how to make replacement parts & much more! Questions & answers. 277 B&W photos & diagrams. 141 Pgs. 9" x 11"

BK-111 Soft Cover **\$37.95**



Atmos Repair Guide & Parts List

3 Manual Set.

1) Caliber #528 Atmos VI Repair Notes & #540 Parts List; covers #526 & #528 repair information and parts lists.

2) Heritage Caliber #528 Repair Notes.

3) Atmos Caliber #540 Repair Guide. Many detailed black and white photographs and diagrams with all parts numbered for easy reference to the parts lists. Step-by-step instructions for disassembly, repair, assembly, and adjustment. Parts lists include photographs of all parts with factory numbers.

35 Pgs. 8-1/2" x 11"

BK-112 Soft Cover **\$6.95**

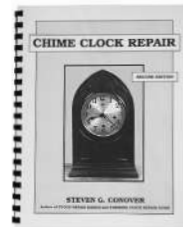

Chime Clock Repair

By Steven Conover

For the beginner to advanced clock repairman. Many detailed drawings, black & white photos & step-by-step instructions. Covers

18 common chime movements, antique to modern, in detail. Seth Thomas-#124, #113, Sonora; New Haven, Sessions 2-train, Waterbury double deck, Ansonia, Globe, Winterhalder, Jacques, Junghans, Hermle, Urgos-06-Series, 9-tubular bell; Kieninger- KSU/RSU; Jauch, Mauthe-W500, & Smith's. Topics include: Chime Basics; Chime Melodies; Disassembly; Assembling & adjusting; Common repair problems; Mainsprings; Weights & Cables; Strike & Time Train problems; Cleaning; Correcting Worn Parts; Adjusting Chime Hammers & more for each of the movements listed above. 210 Pgs. 9"x11"

BK-113 Soft Cover **\$27.95**

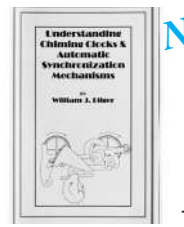

New Understanding Chiming Clocks & Automatic Synchronization Mechanisms

By William J. Bilger

This pamphlet covers the parts and working process of chiming clocks described using pictures, drawings, and figures. It includes a chart detailing the chime notes and sequences for Westminster, Whittington, and St. Michael's chimes. This booklet also explains the Automatic Synchronization Mechanisms and how they work as well as how to adjust the chime train on a Hermle 340-020 movement. 20 pages. 5-1/2" x 8-1/2"

BK-114 Soft Cover **\$4.99**



Cuckoo Clock Repair Made Simple

by Tom Seaman

For the first time a complete guide for in-depth cuckoo repair, written by a man with over 25 years experience. Excellent for beginners or advanced repairmen with 135 clear black & white photos. Covers the most common Regula movements plus pointers on other brands. Topics include: Disassembly, repair of worn pivots; Bushing techniques; Cleaning; Reassembly; Oiling; Installation Into the case; Tips on Musical Cuckoos; Governor mechanism; Testing & Adjustment; Cuckoo Bird & Door Adjustment, Bellow Adjustment; Pendulum Adjustment; Count Adjustment; Parts names with photos; Hanging the Cuckoo; Plus a complete tool list with economy in mind & Suppliers list. 136 Pgs. 9"x11"

BK-115 Soft Cover **\$29.95**

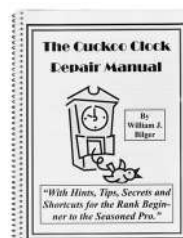

New The Cuckoo Clock Repair Manual

By William J. Bilger

Information on Regula, Herr, and Schatz cuckoo clock movements. The author uses 30 years of experience to go into topics such as the rack and snail, cuckoo bird locking mechanism, disassembly, cleaning, reassembly, music box operation and adjustment. Using many pictures and diagrams he describes such tasks as recovering cuckoo bellows, adjusting 8-point star cams, building a cuckoo clock test stand, and more. There is also a whole chapter on variations that one might find when working on cuckoo clocks. 86 Pgs. 9" x 11"

BK-116 Soft Cover **\$29.95**

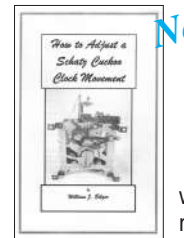

New How to Adjust a Schatz Cuckoo Clock Movement

By William J. Bilger

The book clarifies the workings of a Schatz movement for easy mastery. Helpful explanation of the Schatz differences from other brands. Topics include: plate marking identification, disassembly, cleaning, and required work on the parts; step-by-step reassembly of door, opening mechanism, hammer and bellow lift levers and hammer lift star. 14 B&W photos and diagrams. Basic knowledge of cuckoo clock repair is recommended. 10 pgs. 5-1/2" x 8-1/2"

BK-143 Soft Cover **\$5.50**

BOOKS FOR: Clock Repair for Specific Types of Clocks A-Z



New Adjusting 400-Day Anniversary Clocks

By William J. Bilger

This pamphlet covers five areas that need to be checked in order to properly adjust the 400-Day clock.

The topics are proper mechanical operation, proper escapement action, the beat, regulation or timing, and suspension spring: proper length, wire strength, and position of the fork. This booklet is designed to be paired with Horolovar 400-Day Clock Repair Guide by Charles Torwilliger (our item #BK-118). Includes some drawings and pictures. 39 pages. 5-1/2" x 8-1/2"

BK-117 Soft Cover **\$6.99**



Horolovar 400-Day Clock Repair Guide

By Charles Torwilliger

A must for the collector & repairman. Chapters include: History, -US. Events. Striking, Patents, Pre-WW I; Problems w/Temperature & Timekeeping; Escapement adjustment; Questions & Answers; Myths & Facts; names & trademarks on dials; Pendulums, ratchet wheels, suspension brackets & saddles; Spare parts & repairs; 100's of photos of 400-Day Clocks. 106 Pgs. of Backplate illustrations. 12 Pgs. of susp. spring illustrations & info. Over 100 examples of Pendulums. Ratchet Wheels, & Susp. Brackets & saddles. Complete Listing of Horolovar Replacement parts & tools. Photos/Parts List of common Kundo, Koma, Kern & Schatz clocks. Tables & close-up diagrams for repair. Plus more. 237 Pgs. Oversized. 10th Edition. 9" x 10"

BK-118 Hard Cover **\$29.95**

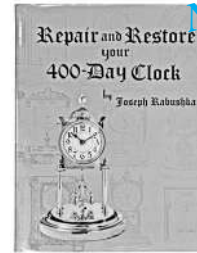

New Repair and Restore your 400-Day Clock

By Joseph Rabushka

This book provides a detailed analysis of each part of the 400-day clock. The author has over 30 years experience in repair and goes into how it works, why it works, and how to determine when it's faulty. Fully-illustrated step-by-step instructions describe in simple terms how to repair any part of the 400-day clock. There are two chapters devoted to the suspension spring alone. Complete with many pictures and figures. 88 Pgs. 7x10"

BK-119 Hard Cover **\$19.95**

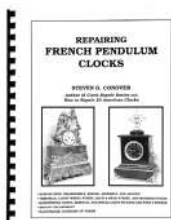

Repairing French Pendulum Clocks

By Steven Conover

Excellent coverage of repair for quality French clocks. Intermediate to advanced repair skills needed. Over 306 black & white photos & detailed diagrams. Step-by-step instructions in disassembly, repair, assembly & adjustment

Covers: Timepiece, count wheel strike, rack & snail strike & Morbier styles; Handling a French mainspring; Brocot escapements. Topics & clocks include: Black Marble timepiece; Rack & Snail visible escapement clocks; Count wheel striking & picture frame clocks; Morbier spring wall clock; Silk Thread suspension. Plus Questions & Answers on French Clocks; Glossary of Terms & a detailed index for easy reference. 92 Pgs. 9" x 11"

BK-120 Soft Cover **\$23.50**



New Grandfather Clocks Book Four

By Steven Conover

Clockmaker's Newsletter Workshop Series.

Modern era: Hermle, Urgos, Kieninger, Gebr.

Jauch, Erhard Jauch, Bell Strikes & American Manufacturers, covered in detail. 241 B&W photos & excellent diagrams. Repair topics include: pillars, wheel & gear work, moon dial repair, machining, clicks, date wheels, pulleys, chains, cannon pinions, pendulum repair, weights & shells, arbors, hammers, chimes & strike, bushing work, fly work, clutch work, beat setting, pallets, verges & much more. Questions & answers, troubleshooting, Mfg. numbering systems & very detailed index for easy reference. Includes new material not in other Conover books. 147 Pgs. 9" x 11"

BK-121 Soft Cover **\$33.95**

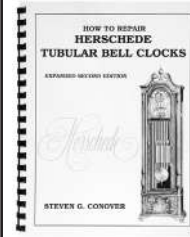

How to Repair Herschede Tubular Bell Clocks

REVISED EDITION

By Steven Conover

In 1984 Herschede stopped production of the tubular bell clocks. Now more than ever, repairers need detailed movement drawings & detailed repair procedures at hand. This revised edition offers so much more. 134 black & white photographs & detailed drawings. Chapters include: Dismantling; How the chime & strike works; Repair procedures; Troubleshooting tips and Q & A. Chime melodies & tube hanging sequence; Assembly & Adjustment of 2-weight mvmt; Dial adjustment; Owner's Manual reproduction with factory set-up Instructions; Authors set-up tips; Detailed movement drawings. Herschede spare parts list; Refinishing plates & wheels; History; Serial no. & mfg. dates: Plans for Herschede factory test stand. 116 Pgs. 9" x 11"

BK-122 Soft Cover **\$27.95**



New Ingraham, New Haven & Sessions Book Eight

By Steven Conover

Clockmaker's Newsletter Workshop Series. Repair tips for: Ingraham, New Haven, Sessions, JS, Turner, EN Welch, G. Brown, Manross, Welch, Spring, Andrews, BB Lewis, & Fashion calendar. Topics include: bushing installation, half-deadbeat escapement, main wheel repair & assembly, clickspring, arbors, alarm mechanisms, strike & chime work, mainsprings & barrels, rear escape clock, pendulum repair, duo strike work, escapements, 2 train work, Patti mainspring & mvmt. work, clock glass decoration, calendar work, leap year function, levers, & much more. Plus articles, questions & answers, histories & a very detailed index for easy reference. Includes new material not in other Conover books. 149 Pgs. 9" x 11"

Haven, Sessions, JS, Turner, EN Welch, G. Brown, Manross, Welch, Spring, Andrews, BB Lewis, & Fashion calendar. Topics include: bushing installation, half-deadbeat escapement, main wheel repair & assembly, clickspring, arbors, alarm mechanisms, strike & chime work, mainsprings & barrels, rear escape clock, pendulum repair, duo strike work, escapements, 2 train work, Patti mainspring & mvmt. work, clock glass decoration, calendar work, leap year function, levers, & much more. Plus articles, questions & answers, histories & a very detailed index for easy reference. Includes new material not in other Conover books. 149 Pgs. 9" x 11"

BK-123 Soft Cover **\$33.95**



New Jauch Movements Manual

With Jauch out of business, this manual is a wealth of information on 43 styles. Black and white photographs of movements.

Find 8-day, weight-driven, grandmother, grandfather, tubular bell, and more. Details include: Movement schematic; Plate and minimum case dimensions; Pendulum lengths with corresponding handshaft to bob center, bob diameter, and bob swing in mm and inches; Weight shell diameter in mm and inches, and necessary time, strike, and chime weight requirements in kg and lbs. So much information is invaluable for replacing missing parts. 62 pages. 8-1/2" x 11"

BK-124 Soft Cover **\$6.99**



New How to Repair Jefferson Golden Hour Mystery Clock

By William J. Bilger

Today, limited information can be found for the repair of these fascinating clocks.

Help can be found on specific parts and their function, disassembly, cleaning & reassembly. General repair tips are given on broken crystal glass, malfunctioning electric motors (repair or replacement), frayed & cracked electric cords, adjusting the time keeping, Radium 226 numerals & hour marks. Plus, an interesting history and explanation of different models, parts sourcing & internet information. 14 B&W pictures & helpful diagrams. 29 Pgs. 5-1/2" x 8-1/2".

BK-125 Soft Cover **\$6.99**

BOOKS FOR: Repair for Specific Types of Clocks A-Z; Encyclopedia; & Gears.



Manual for Overhaul, Repair & Handling of US Navy Mechanical Boat & Deck Clocks, Chelsea Type

The official 1953 Dept. of the Navy Chelsea repair manual for models 12E & 17E. With military efficiency the chapters include: Types of Clocks; Movement description, disassembly, inspection, repair, cleaning & reassembly; Escapement disassembly, inspection, operations & reassembly; Testing & adjusting. 83 detailed drawings & diagrams. Detailed schematics & parts lists for each clock. Plus Plusdiagrams of 33 specialty repair tools & tool list with cross reference to repair diagrams, tool description & tool use. 101 Pgs. 8-1/2" x 11"

BK-126 Soft Cover **\$29.95**

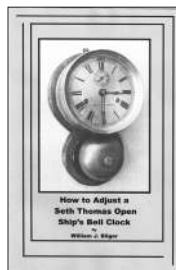

How to Adjust a Seth Thomas Open Ship's Bell Clock

By William Bilger

The #7 movements & workings are explained in detail: 24 hr. watch system and corresponding hours; bell striking patterns and corresponding hours; 1-day feature, mainspring differences, count wheel and hammer wheel. Topics include: Cleaning, lubrication & tricks to reassembly, problem solving; correct pin, slot, hook and lever position for hammer wheel, count and locking levers; proper remounting of gears and alignment; explanation of the time train; mainspring sizes, recommended reference sources for more detailed mechanics. 10 B&W photos, charts & diagrams.

13 Pgs. 5-1/2" x 8-1/2"

BK-127 Soft Cover **\$5.50**

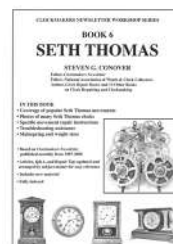

Seth Thomas: New Book Six

By Steven Conover

Clockmaker's Newsletter Workshop Series.

Histories, repair & troubleshooting info on mvmts. & their mechanisms. #89 (AL & I); stopworks mechanism, strike levers, assembly, regulator mechanism. Chime mvmts. (#113, #124. Sonora). Strike mvmts. (Athens, #48, #51, #66, #120, Plymouth, Sharon Steeple A-200). Calendar, alarm clocks & 30-day (#86T, #103, #41AS, Regulator #2). Plus: Mainsprings, weight sizes, pendulum work, how to make replace parts, questions & answers, and a detailed index for easy reference. Includes new material not found in other Conover books. Features 300 B&W photos & detailed diagrams. 158 Pgs. 9" x 12"

BK-128 Soft Cover **\$35.95**



Striking Clock Repair Guide

By Steven Conover

Great for clock repair beginners & hobbyists. Professional clock-makers & advanced repairmen will find this an invaluable time saver

in the workshop. Use as a textbook for study or as a guide to repair the 20 specific mvmts covered. Clear instructions, 48 photos & over 100 diagrams. Topics include Amer. count wheel mechanisms by Ansonia, Seth Thomas, Ingraham, New Haven, & others; French count wheel & rack strike movements; German wall clock with count wheel strike; Hermle 130-series strike movement; 4 different ships bell clocks-Seth Thomas #7, Schatz, Hermle, & Salem (Mauthe); Instructions on winding brass wire springs for strike arbors; Making a bending tool that adjusts levers easily. 90 Pgs. 9" x 11"

BK-129 Soft Cover **\$22.50**



Tools, Tips & New Projects Book Two

By Steven Conover

Specialized tools for the beginner to advanced repairmen. Tool making: For lathes, bushing machines, mainspring winders; pullers, pinion remover, pallet punch, cutters, anvils, burnishers, stake tool, gauges, tool stands, tool box. Using tools: Mvmt. holders & test stands, arbor supports, bushing machine, depth tool, saws & blades, clock timers, verge adjuster, power punch, gear & pinion cutter, lathe attachments, escape wheel tooth straightener, vices, millers, grinders, sanders, polishers. Practice projects & repair tips galore! Very detailed index & material sources. 307 B&W photos & detailed diagrams. 181 Pgs. 9" x 11"

BK-130 Soft Cover **\$37.95**



New Tubular Bell Clocks Book Five

By Steven Conover

Clockmaker's Newsletter Workshop Series.

Find info on: German, English & Herschede. Discusses topics unique to the tubular bell clock: Mvmt. & chime testing techniques, work on bushings, gathering pallets, pivots, hammers, weights, train work, moon dial adjustment, wheels, racks, hour bridge, chime & strike work, pendulums, clock plate treatment & more. Special topics on: Restoration, making of parts, modification techniques, questions & answers, troubleshooting, in-home repairs and info sources. Detailed index for easy reference. 216 B&W photos and diagrams. 125 Pgs. 9" x 11"

BK-131 Soft Cover **\$31.95**

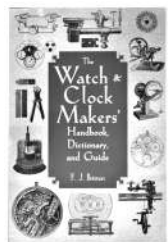

New The Watch & Clockmaker's Handbook, Dictionary, and Guide

By F.J. Britten

Widely regarded as one of the most famous and useful encyclopedias on watch and clock making. Featuring more than 400 detailed illustrations, this book is a great reference for hobbyists, artists, antiques dealers, history buffs, and horologists. The author defines various technical terms used in the trade as well as offering information of his own which he thought would benefit young workmen and students. 491 Pgs. 9x11"

BK-132 Soft Cover **\$34.50**



How to Make a Pivot Polisher And Micro Drilling Attachment for a Small Lathe

By Robert Porter, CMW

This simple, easy-to-make & inexpensive attachment is used to grind & polish pivots, and micro drill work.

Instructions cover: Laps, measurements for the base plate & spindle guide block & motor slide; spindle location, assembly, making a lap spindle, truing, helpful advice on lapping; micro drilling, making spade drills, sharpening drills, making a spindle for micro drills, motor modifications for faster speed & supplier parts list. 38 B&W close-up photos and diagrams. 25 Pgs. 5-1/2" x 8-1/2".

BK-133 Soft Cover **\$8.00**



The Clock & Watch Makers Guide to Gear Making & other machines

by Robert Porter, CMW

224 B&W photos to help you design gears & cutters to make them. Step-by-step examples, reference charts, gear & cutter design sheets are provided. Topics includes: History, advise & terminology; watch & clock gear forms for various trains; required tools; making 7 lathe attachments to aid in gear making; making cutters; 9 quick ref. design sheets for 6-16 leaf pinions; driving gear work; hardening, tempering & polishing work; 4 quick ref. & design sheets for 5-35, 36-39 & 70 teeth & semi-involute gears; 3 quick ref. & design sheets for wheels that drive 6-8, 9-12, 14-16 pin wheels; lantern pinion design; music wire sizes & equiv. modal values; clutch pinion; gear making; setting; broaching; square hole; design & cutting of clutch teeth; plus much more. 192 pgs. 8-1/2" x 11"

BK-134 Soft Cover **\$33.95**

BOOKS FOR: Lathes & Machining; & Repair of Specific Movement Parts A-Z.

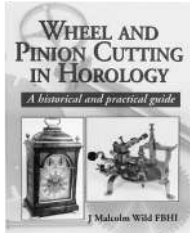

Wheel & Pinion Cutting in Horology

By J. Malcolm Wild

An excellent guide on equipment and how to use it. Over 500 B & W photos & line drawings. Covers

early methods of wheel cutting, theory, practical instruction & detailed info on equipment. Chapters include: Pinions & pinion wire; Cutting machines; Attachments; Theory; Wheel Cutting; Pinion Cutting; Cutters; Mounting; Finishing & replacing worn pivots; Making the rack & snail; French count wheels; Construction of 5-turn Geneva stopwork; Cutting unusual escape wheels; Replacing missing pendulums, arbors, wheels or pinions; Tooth form & proportions; Value charts for 6 thru 16 teeth wheels; Lantern Pinion work; Pinion tooth & wheel cutter dimension charts; supplier list. 253 Pgs. 8" x 10-1/2".

BK-135 Hard Cover **\$54.00**

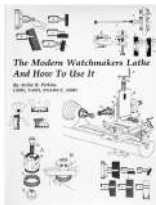

The Modern Watchmakers Lathe & How to Use It

by Archie B. Perkins

An excellent all inclusive course on lathe work for any clock or watch repairman. Filled with all the necessary skills for repair & replacement of hard to find a missing parts. 548 B & W photos & diagrams. Chapters: Lathe & its construction; Tailstock & their attachments; Split wire chucks; Wheel & crown chucks; Jewel & sub-chucks & cement brasses; Other special chucks; The hand rest & its attachments; The sliderest, grinder & pivot polisher; The gear cutting & milling attachment; Lathe maintenance & care; Gravers, Measuring, Basic cuts; Thread cutting; Making pivots, balance staffs & pallet arbors; Making Winding stems; Setting bezel jewels; Repivoting pinions; Using the sliderest; Making wheel & pinion cutters; indexing; Making & mounting wheels & pinions; Saws & sawing; Files & filing; Plus 11 Tables on Split wire chuck sizes; Wheel chuck sizes; Jewel pusher sizes; Pivot drill sizes; Swiss screwplate sizes; Amer Stand. Taps & Dies; Formulas for thread cutting; Indexing at 40:1 & 80:1 ratio; Jewelers saw blade sizes; File selection. 393 Pgs. 9" x 11"

BK-137 Hard Cover **\$89.95**

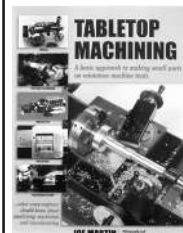

Tabletop Machining

By Joe Martin

Provides a basic knowledge for making small parts on miniature machine tools, from beginner to advanced. Over 507 color photos, detailed drawings & schematics.

Topics: General Machining - equipment, metal forming, finishes, joining, abrasives, measuring, coolants & oils, terms. Lathe operations - basics, holding & supporting work, thread cutting, knurled finishes, watch & clock tools. Milling operations - holding, instructions, squaring, rotary table, gears & trains, accessories. Tips - the workshop, alignment & adjustment, engineering drawings, Q & A. Project plans, lathe & mill schematics, RPM gauge & conversion tables, plus a huge list of parts & information resources. 350 Pgs. 8-1/2" x 11"

BK-138 Soft Cover **\$40.00**

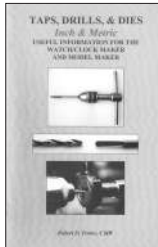

Taps, Drills & Dies Inch & Metric

By Robert Porter, CMW

Information for the watch, clock, model maker and hobbyist. Topics include: Screw thread standardization, length engagement, types of taps & their markings;

use of pitch gages, determining screw thread sizes, thread size and corresponding tap drill charts; how to make a special tap, number, letter and fractional drill size charts; making your own tap drills, high quality swiss metric tap and die sets and their use; metric thread, and repair examples. Charts for pitch & tap drill size, German Lowensherz & British thread series, watch stem & crown thread, and vintage pocket watch & Elgin thread & tap.

79 B&W photos & diagrams. 60 Pgs. 5-1/2" x 8-1/2"

BK-139 Soft Cover **\$14.00**



New How to Adjust the American Count Wheel System

By William J. Bilger

Helpful information of the System parts and their function individually and as a whole; Variations of Count Wheel Systems; Half hour strike; Common points - locking, warning, releasing, counting, striking, speed control; set up & troubleshooting. 15 excellent step-by-step diagrams. Plus Lists of clock supply houses, professional clock organizations, magazines & internet information & chat group sties. 32 Pgs. 5-1/2" x 8-1/2"

BK-140 Soft Cover **\$7.50**



New The Rack & Snail Count System: Everything You Always Wanted to Know About It

By William J. Bilger

Although difficult to understand because of its fast operation, the rack & snail system is 'slowed down' into simple detail by the use of 18 detailed diagrams and explanations. The Regula #25 30-hour rack & snail system is used. Topics include: Parts identification, specific information on each parts function & the interaction of the individual parts to the whole. The principles learned here can easily be adapted to other movement rack & snail systems. 21 Pgs. 5-1/2" x 8-1/2"

BK-141 Soft Cover **\$4.99**

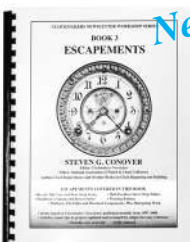

New Escapements: Book Three

By Stephen Conover

Clockmaker's Newsletter Workshop Series. Escapements covered are: Recoil - tall case and bent strip styles; Deadbeat - Graham & Brocot; Platform - Pin Pal-

lets & pinwheel; Half-Deadbeat Bent Strip Pallets; Floating Balance. Topics covered: Identification, terminology, adjustment, problem solving, repair, replacement, making parts vs. buying parts, angles, pallet work, installation, and verges. Plus a large selection on hairspring work, suspension springs & pendulums (types, weights, calculating the beat, regulating, beat rate chart by clock mfg., problems). Includes: Questions & answers, detailed index, 264 B&W photos, graphs, charts and detailed diagrams. 159 Pgs. 9" x 11"

BK-142 Soft Cover **\$34.95**



The Pin-Pallet Escapement Adjustment & Repair

By Robert Porter, CMW

Also called the Brocot escapement. Detailed diagrams help explain the part names, working, repairing and adjusting. Topics include: Recording information for future reference, determining perpendicularity and correction, putting escapement and clock 'in beat', accurate measuring, how to check & adjust center distance, pendulum suspension & regulating assembly, modification of tools to aid in adjustment, making a suspension spring & rod assembly, making & replacing pallet pins & size chart, making a drill guide, bushing clock plates & size chart. Info on unusual modes: Gilbert series, S. Thomas series, alarm clock & watches. 37 B&W photos and diagrams. 44 Pgs. 8-1/2" x 11"

BK-144 Soft Cover **\$14.00**

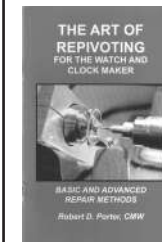

New The Art of Repivoting For the Watch and Clock Maker

By Robert Porter, CMW

Examination of damaged parts, repivoting wheels, pinions & arbors; and drilling arbors. Topics include: Use of the Jacot pivot lathe with concepts easily enlarged for a Sherline lathe; the Moseley lathe, useful lathe attachments, and use of a micrometer. Instructions for making a pivot gauge, micro spade drill, support attachment, repivoting attachment, modifying a cement brass chuck, making a drilling quill and motor adaptor; and component resource supplier list. 98 B&W photos and diagrams. 60 Pgs. 5-1/2" x 8-1/2"

BK-145 Soft Cover **\$14.00**

BOOKS FOR: Clock Identification & Pricing A-Z

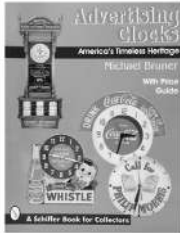

Advertising Clocks: America's Timeless Heritage

by Michael Bruner

Over 300 examples of advertising clocks from the 1870's wooden mechanicals to the neon electrics. All in

full color photographs. Complete price guide, brief histories, manufacturers, case description & dimensions. Types of clocks shown: Spring wound pendulum; Non-pendulum spring wound; Neon; Back-lit & much more. Advertisers include: Reed's Tonics, Coke, Pepsie., Dr. Pepper, Lucky Strike, Orange Crush, Western Union, Victrola, Ford & much more. Advertising themes: Diners, tires, motor oil, cigars, insurance, doctors, pharmacies, razors, radio, colas, liquor & beers, medicines, shoes, foods, worlds fair, gas stations, dog food. & much more. 128 Pgs. 8-1/2" x 11"

BK-146 Soft Cover **\$29.95**

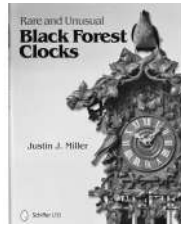

New Rare and Unusual Black Forest Clocks

By Justin J. Miller

The creativity, innovation, and craftsmanship represented by the clocks from

Germany's Black Forest region are well covered in this definitive guide. This engaging book vividly brings to life the rich, romantic history of families and entire communities of craftsmen cooperating to create these unique timepieces. It covers Black Forest clockmaking, the cuckoo clock, clocks with automata, musical clocks, complicated clocks, as well as much needed information on preeminent clockmakers Johann Baptist Beha and Emilian Wehrle. Over 700 striking images showcase the finest examples of clocks made in the region. 300 Pgs. 9x11"

BK-147 Hard Cover **\$84.95**



Black Forest Clocks

By Rick Ortenburger

600 Color & black & white photos with name, date, description of clocks & movements. Excellent information & histories (1700-1930) on over 32 makers & manufacturers such as Mayer,

Furtwangler, Badische, Hettich, Union, Lorenz Bob, Jahreuhren, Haas, Bauerle, Maier, Werner, Wilde, Noll, Kaiser, Mauthe, Kienle. Junghans, Hamburg, Jaegler, Dold, Wehrle, Sorg, Ruth, Bruder, Villingen, Herbstrehr, & more. Types of clocks: animation, flute, cuckoos, shelf, peddler, picture frame, mantles, alarm, floor, box, apostle, shield, regulator, calendar, swingers, bracket, freeswinger, wall, brass case, balloon, porcelain, keyhole, gallery, trumpeter, Jockele, organ & flute, wag, animation, French style & more. Great factory photos, original catalog pages & advertisements. With price guide. 268 Pgs. 9" x 12"

BK-148 Hard Cover **\$69.95**



Chronometer Makers of the World

By Tony Mercer

A comprehensive listing of chronometer makers from the earliest to the contemporary, Plus a fascinating history of the chronometer & their makers.

Chapters include: I.D. marks & dating; Origins of the Detent Escapement; The purpose of the Chronometer; Maker John Harrison; The British admiralty & the Greenwich Trials; Nautical Science-Kelvin & Hughes; Mercer Chronometers & parts schematics; International Chronometers; List of Makers - Address, dates living & of mfg., serial numbers & brief history.; History of the Royal Observatory; British regional craftsmen & movement makers; Frame makers; Chron. Museums today. 87 color & B&W photos & diagrams. 301 Pgs. 5-1/2" x 8-1/2"

BK-149 Hard Cover **\$55.50**

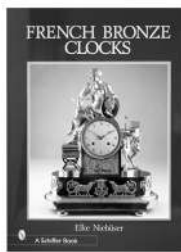

French Bronze Clocks 1700-1830

By Elke Niehuser

Known worldwide for their precision & magnificent sculptures, shown in over 300 color & black & white photos of clocks, movements & stands.

Each with maker, date & case description. Plus a directory of 1365 bronze table clocks, with makers, factories & dates. Periods: Louis XIV, Baroque, Regency, Rococo, Classical. Chapters: The Movement-pendulum, striking & clockwheel, movement & escapement; Clock makers; Casting, chasing, gliding & care; French Art History; Gods, heros & muses; Armor & Venus; Heroic & Haughty Deeds; Literary influences; The seaman; American Indian; African; Atala & Chactas; Every day scenes; Index of names; plus much more. 267 Pgs. 9-1/2" x 12-1/2"

BK-150 Hard Cover **\$83.95**

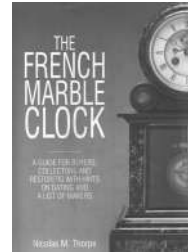

The French Marble Clock

By Nicolas Thorpe

A Guide for buyers, collectors & restorers with hints on dating & a list of makers. 100's of black & white photos, history, mfg. dating, restoration,

movement function, case description & more are discussed. Chapters include: History of the Marble Clock, How to Buy, Examine & Date a Clock; Movement of French Marble Clocks; Understanding the Pendulum; Rack & Locking Plate Striking Movements; The Restoration of a Timepiece; Restoring a Striking Movement; Pendulum Escapement Repairs-Cleaning & Testing the Movement; Extraction & Types of Marble, Restoring Marble Cases; Collectors Clocks; Makers & Their Marks. Plus a bibliography for further reading. 277 Pgs. 7" x 10"

BK-151 Hard Cover **\$55.95**

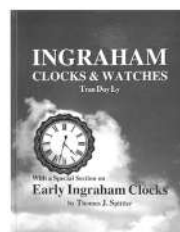

Ingraham Clocks & Watches

By Tran Duy Ly

Over 1,280 black & white photos & illustrations of clocks, watches, statues, ornaments, cases, movements, motors, clock parts & original advertisements. Each item has a

description, date, size, original selling price & current price. Clocks include: Advertising, alarm, auto, banjo, calendar, carriage, electric, hanging, mantel (8 types), mission, porcelain, statues & ornaments, pocket & wrist watches, movement illustrations, parts lists & history of the factory with orig. photos & early Ingrahams 1841-1857. Indexed for easy reference. Helpful tips on authenticity, buying, sellings, collecting, etc. 384 Pgs. Includes 1999 Price Guide Update. 9" x 11"

BK-152 Hard Cover **\$49.95**

1999 Price Guide Update

BK-153 Sold Separately Paperback **\$9.50**



New Precision Pendulum Clocks The quest for Accurate Timekeeping

By Derek Roberts

This beautiful book relates the incredible story of how leading clockmakers,

primarily of England, struggled with the accuracy of timekeeping for over 300 years. A remarkably thorough yet concise text, by several of today's leading horologists, is accompanied by nearly 300 stunning photographs of clocks, which demonstrate each fascinating development. From museums of international significance, as well as private collections worldwide, the best examples of each new invention to establish accurate timekeepers is illustrated and recorded here. 221 Pgs. 8-1/2" x 11"

BK-154 Hard Cover **\$29.95**

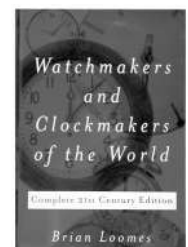

Watchmaker's & Clockmakers of the World

by Brian Loomes

NEW & Updated! 2 Volumes in one. Complete 21st Century Edition. Contains over 90,000 watch & clockmakers working between the late 16th & early

20th centuries. An excellent reference volume for collectors, dealers, museums, historians & libraries. Covers: Makers & retailers of clocks, watches, scientific instruments, sundials & barometers. Each reference includes (if known): The full name; place & dates of work; birth place; apprenticeship; guild status; level of mastery; marital status; company affiliations; monograms; types of clocks made; birth & death dates; known successors. Also included an explanation of abbreviations & conventions. Plus recommended bibliographies for further reference. 873 Pgs. 5-1/2" x 8-1/2"

BK-155 Hard Cover **\$79.95**

BOOKS FOR: Clock Identification & Pricing A-Z



Seth Thomas Clocks & Movements Vol. 1
By Tran Duy Ly

3rd Edition. Expanded & updated to be even more comprehensive. Vol. 1 contains Alarms through Mantel-Leather. 1928 B & W photos of clocks, dials, advertisements, movements, parts & much more. Chapters include; Factory history; History of each individual clock style; Chronology; Dating S. Thomas clocks; Alarm clocks-winding & electric; Automobile; Bango; Calendars-wall, mantel, fashion; Carriage; Chime-key wind & electric; City clocks; Cottage; Crystal regulators; Hanging-keywind & electric; Longcase & standing regulators; Mantel-Adamantine, cabinet, cabinet electric, column, desk, desk elect., iron & leather. All with data description & size. Important tips for the collector & restorer. Includes the 2005 Price Guide Up-date covering Vol. 1 & 2. 576 Pgs. 9" x 11"

BK-156 Hard Cover **\$69.50**
2005 Price Guide Update
BK-157 Sold Separately Paperback **\$13.00**

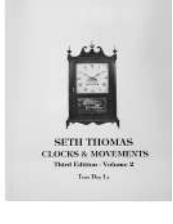

Seth Thomas Clocks & Movements Vol. 2
by Tran Duy Ly

3rd Edition. Expanded & Updated to be even more comprehensive. Vol. 2 contains Mantels-Marble through Wrist Watches. Over 1,645 black & white photos of clocks, dials, movements, parts, original factory drawings & much more. Chapters include: Mantel-marble, onyx, electric, novelty, musical, ogee, pillar & scroll, porcelain, series, steeple, swinging frames, tambour, wood cases, violin; Ships Bell clocks-hanging, mantel; Ship chronometers & levers; Statuettes & candelsticks; Street clocks; Tower; Watches; Wrist watches; Plymouth; Seth Thomas & Sons Clocks; Gas fixtures; Ornaments; Dials-descriptions, saches, glass & illustrations; Movements-tables, diagrams, descriptions, Illustrations All with date description & size. Important tips for the collector & restorer. 1152 Pgs. 9" x 11"

BK-158 Hard Cover **\$69.50**



Vienna Regulators & Factory Clocks
By Rick Ortenburger

Extensive research in Europe & America has gone into this work covering early, transitional, serpentine, altdeutsch, Baroque, & factory-made clocks. Chapters: Early & Late Styles 1780-1860; Transitional & Serpentine 1860-1870; Industrialized Factory Clocks 1870-1930; Movements, Dials, cases & weights. Clocks: Latemduhr, Biedermeier, Lantern, Brettluhr, Vienna Regulators, Floor standing, 1,2,&3 weight, Art Nouveau, 5 Year, Fusee, Free-Swingers, Calendar, Box Clock, RA, Miniature. Over 72 Makers & Manufacturers including: Marenzeller, Fertbauer, Deffner, Weiskopf, Brandl, Binder, Becker, Bosch, Stadler, Rammel, Junghans, Ludwig, Elsner & Petrovis, Himmelmayer, Anton Mayer, Blaschko, Banyai, Happacher, Lehner, Olmutz & more. Over 342 black & white photos with price guide, histories, definitions, reference guide & recommended reading list. 175 Pgs. 9" x 11"

BK-159 Hard Cover **\$39.95**

New

Steven Conover's Clockmaker's Newsletter Workshop Series

Book 1: Repairs	\$37.95	Item # BK-106 (pg. 125)
Book 2: Tools, Tips & Projects	\$37.95	Item # BK-130 (pg. 128)
Book 3: Escapements	\$34.95	Item # BK-142 (pg. 129)
Book 4: Grandfather Clocks	\$33.95	Item # BK-121 (pg. 127)
Book 5: Tubular Bell Clocks	\$31.95	Item # BK-131 (pg. 128)
Book 6: Seth Thomas	\$35.95	Item # BK-128 (pg. 128)
Book 7: Ansonia, Gilbert, Waterbury	\$37.95	Item # BK-111 (pg. 126)
Book 8: Ingraham New Haven, Sessions	\$37.95	Item # BK-123 (pg. 127)

Clock & Watch DVD's

Cuckoo Clock Repair by Bruce Rasmessum (DVD) Item # **VDO-100** **\$39.95**

Complete cuckoo clock function, theory and repair is shown & explained. Includes: wooden, countwheel, quail, music box, rack & snail, as well as, the modern movements (Herr, Regula, Baduf, etc.) Disassembly to reassembly: positioning of pins, levers & wheels for proper synchronization, repair of bellows, hands & birds, a repair stand, and wire benders, etc. Plus much more! Enlarged color drawings and detailed close-up views are amply shown for clarity and understanding. A basic understanding of time & strike movements is necessary. *105 minutes.*

General Clock Repair by Bruce Rasmessum (DVD) Item # **VDO-101** **\$39.95**

Learn clock repair, the easiest & fastest way, with this highly successful full color DVD. Instructions on the repair of American & European pendulum striking clocks. Parts are identified, named & function explained using schematic drawings & close-up shots. Covers tools required, disassembly, mainspring work, cleaning the movement, inexpensive clock cleaner, proper veering & testing, pivot work, bushing, repair lantern & leaf pinions, teeth work, escapements, escape wheels, repair mainspring, reassembly, rack & snail & countwheels, oiling & oilers, setting the beat & much more. Many inexpensive tricks, tools, methods, etc. *110 minutes.*

Servicing the Atmos Clock by Gerald Jaeger (DVD) Item # **VDO-102** **\$50.00**

This DVD demonstrates the proper way to disassemble, clean, check time and reassemble the Atmos clock. Topics covered include: Special tools and suitable substitutes, repairing suspension springs, handling of the mainspring, pallet poising and bellow replacement. This video is for clock or watch repairmen who consider themselves intermediately experienced. *Approx. 2 hours, 25 min*

Identifying the Fake Rolex by Charlie Cleves, CMW (DVD) Item # **VDO-103** **\$40.00**

Excellent for buyer, sellers & repairmen. Learn to recognize the fakes by: papers, misspellings, bands, links, coloring, construction, refinished bands & cases, pivot holes, boxes, under carating. Other topics include: dials - wording, material, coloring, hallmarks; Crystals & bezels; waterproofing, markings. Gem cuts: quality & settings, carat testing. Serial numbers. Case backs: shapes, hallmarks. After market watch discrepancies to look for. How to identify true Rolex watches with mismatched Rolex replacement parts. Legal ramifications and self-protection tips for fake or stolen watches. *90 minutes.*

Special Coupon Offers

No need to clip the coupon, just give us the Coupon Number in the left bottom corner of the coupon.

FREE GROUND SHIPPING

With a purchase of \$100 or more

Excludes: Next Day, 2nd Day & 3rd Day.

Excludes: Solutions, large clock regulating stands, lyre pendulums, weights, bushing machines, mainspring winders and glass domes.

Excludes: Shipments to Alaska, Hawaii, Puerto Rico, or outside the continental U.S. One coupon per order.

#C-1

PRE-PAY & GET Free Ground Shipping

With a purchase of \$200 or more

Pre-payment must be by check, money order or credit card.

Excludes: Next Day, 2nd Day & 3rd Day.

Excludes: Solutions, large clock regulating stands, lyre pendulums, weights, bushing machines, mainspring winders and glass domes. Excludes: Shipments to Alaska, Hawaii, Puerto Rico, or outside the continental U.S. One coupon per order.

#C-2

PRE-PAY & GET Free Ground Shipping

With a purchase of \$300 or more

Pre-payment must be by check, money order or credit card.

Excludes: Next Day, 2nd Day & 3rd Day.

Excludes: Solutions, large clock regulating stands, lyre pendulums, weights, bushing machines, mainspring winders and glass domes. Excludes: Shipments to Alaska, Hawaii, Puerto Rico, or outside the continental U.S. One coupon per order.

#C-3

3 FREE MINI QUARTZ MOVEMENTS

With a purchase of 30 or more Mini Quartz Movements

Choose from MTW-20's, 35's, 40's, 70's or 80's
HANDS **NOT** INCLUDED!
One coupon per order.

#C-4

5% DISCOUNT

On Pre-Paid Orders of \$100 or more

Pre-payment must be by check, money order or credit card.

Excludes: Bushing machines.

One coupon per order.

#C-5

7% DISCOUNT

On Pre-Paid Orders of \$200 or more

Pre-payment must be by check, money order or credit card.

Excludes: Bushing machines.

One coupon per order.

#C-6

7% DISCOUNT

On Pre-Paid Orders of \$200 or more

Pre-payment must be by check, money order or credit card.

Excludes: Bushing machines.

One coupon per order.

#C-7

5% DISCOUNT

On Pre-Paid Orders of \$100 or more

Pre-payment must be by check, money order or credit card.

Excludes: Bushing machines.

One coupon per order.

#C-8

